

User Guide

FreeSpeak Edge R4.1 Base Station User Guide



Part Number: PUB-00113 Revision H

March 20, 2026

Document reference

FreeSpeak Edge® Base Station

Part Number: PUB-00113 Revision H

Legal disclaimers

Copyright © 2026 HME Clear-Com Ltd

All rights reserved

Clear-Com and the Clear-Com logo are trademarks or registered trademarks of HM Electronics, Inc.

The software described in this document is furnished under a license agreement and may be used only in accordance with the terms of the agreement.

The product described in this document is distributed under licenses restricting its use, copying, distribution, and decompilation / reverse engineering. No part of this document may be reproduced in any form by any means without prior written authorization of Clear-Com, an HME Company.

Clear-Com Offices are located in California, USA; Cambridge, UK; Dubai, UAE; Montreal, Canada; and Beijing, China. Specific addresses and contact information can be found on Clear-Com's corporate website: www.clearcom.com

Clear-Com contacts

Americas and Asia-Pacific Headquarters

California, United States

Tel: +1 510 337 6600

Email: SalesSupportUS@clearcom.com

Europe, Middle East, and Africa Headquarters

Cambridge, United Kingdom

Tel: +44 1223 815000

Email: SalesSupportEMEA@clearcom.com

China Office

Beijing Representative Office

Beijing, P.R. China

Tel: +8610 59000198/59002608

Email: SalesSupportChina@Clearcom.com

Table of contents

Table of contents	3
1 Introduction	7
1.1 Product Features	8
1.2 FreeSpeak Edge Base Station Interconnections	9
2 Installing FreeSpeak Edge Base Station	10
2.1 Front Panel Connectors, Controls and Indicators	11
2.2 Intercom Touchscreens	12
2.3 Rear Panel Connectors and Indicators	15
2.4 System Power	16
2.5 Clear-Com Ethernet Cable Recommendations	18
2.6 Stage Announce and Program Audio	18
2.7 Setting the Management IP Address	19
2.8 Saving and Restoring System Configuration	20
2.9 Resetting to Default	21
3 Configuring from the Front Panel	22
3.1 Introduction to Configuring from the Front Panel	23
3.2 Setting the Management IP Address	23
3.3 Passwords, IP Addresses, Reset to Default, Save and Restore Configuration	24
3.4 Front Panel Menus	27
4 The Core Configuration Manager (CCM)	33
4.1 Changing the CCM Password	34
4.2 Hardware Page Overview	34
4.3 Configuration Page Overview	36
4.4 Status Page	40
5 Example Applications	41
5.1 FreeSpeak Edge Base with FreeSpeak II Wireless - E1	42
5.2 FreeSpeak Edge Base with FreeSpeak II Wireless-E1 and Splitter	44
5.3 FreeSpeak Edge Base with FreeSpeak Edge IP Transceivers	46
5.4 Split Frequency Setup (5, 2.4 and 1.9 GHz System)	48

6 Using FreeSpeak Wireless Intercom	49
6.1 Overview of Transceivers	50
6.2 Connecting Transceivers Over E1	50
6.3 Adding IP Transceivers	55
6.4 Connecting Transceivers Over IP	56
6.5 Network Setup for IP Transceivers	57
6.6 Registering FreeSpeak Beltpacks	61
6.7 FS Edge Transceivers	64
7 Using Dante Systems	67
8 Using 2-Wire Systems	71
8.1 Introduction to 2-Wire Systems	72
8.2 2-Wire Port Compatibility	75
9 Using 4-Wire Systems	76
9.1 Connecting 4-Wire	77
9.2 Port Function (4-Wire Pinout)	81
9.3 Connecting 4-Wire Clear-Com to Clear-Com	82
9.4 Setting Port Function (Pinout) on a 4-Wire Connection	83
10 Network Setup	84
10.1 Network Setup for IP Transceivers	85
10.2 LAN Configuration Rules	89
10.3 AES67 Network - PTP Follower Configuration	91
11 Configuring from the CCM	93
11.1 Configuring Station Settings	94
11.2 Adding IP Transceivers	100
11.3 Registering Beltpacks	101
11.4 Channels and Groups	103
11.5 Managing Channels	105
11.6 Managing Groups	110
11.7 Managing Roles	116
11.8 Setting up GPIOs and Logic Events	124
11.9 Monitoring System Status	127

11.10 Monitoring the Event Log	131
11.11 Monitoring the Logic Page	132
12 Security	133
12.1 Warning	133
12.2 Introduction	133
12.3 Forcing HTTPS	134
12.4 Using Security Certificates	136
12.5 EasyDNS update button (Edge Base 4.1 and above)	136
13 Upgrading Firmware	137
13.1 Upgrading using the CCM	137
13.2 Upgrading using a USB stick	137
14 Spare parts	139
15 Front Panel Menu Reference Tables	140
15.1 Audio Settings	141
15.2 Host Settings	141
15.3 2 W Audio (A/B) (C/D)	142
15.4 Discovery	142
15.5 Transceiver	143
15.6 Networking	144
15.7 Administration	145
16 Appendix A: Pinouts	147
16.1 GPIO pinouts	147
16.2 2-Wire Pinouts	149
16.3 4-Wire Pinouts	150
16.4 DECT Sync	150
17 Appendix C: Specifications	151
17.1 FreeSpeak Edge Base Station	152
17.2 Capacity	155
17.3 Network Specifications	156
18 Appendix D: Spare Parts	158
19 Appendix E: Front Panel Menu Reference Tables	159

19.1 Audio Settings	160
19.2 Host Settings	160
19.3 2 W Audio (A/B) (C/D)	161
19.4 Discovery	161
19.5 Transceiver	161
19.6 Networking	162
19.7 Administration	163
20 Regulatory Compliance (Regulatory Model: 1410)	165
20.1 FCC Notice	165
20.2 FCC/IC/EC RF Exposure Warning	166
20.3 Industry Canada Compliance Statement	166
20.4 Korean Notice	166
20.5 European Union (CE mark)	167
20.6 United Kingdom (UKCA Mark)	167
20.7 Electrical and Electronic Equipment (WEEE) Waste	168

1 Introduction

This chapter provides an overview of the FreeSpeak Edge Base Station. It contains the following sections:

1.1 Product Features	8
1.2 FreeSpeak Edge Base Station Interconnections	9

1.1 Product Features

FreeSpeak Edge Base Station is a low-latency intercom platform that interconnects with wired and wireless intercom systems. It supports:

- Six IP transceivers (any combination up to a total of six of FreeSpeak II and FreeSpeak Edge TCVRs)
- 10 E1 transceivers (any combination up to a total of 10 of FreeSpeak II 1.9 and 2.4 TCVRs)
- 16 wireless beltpacks (any combination up to a total of 16 of FreeSpeak II and FreeSpeak Edge beltpacks)
- Eight Dante channels
- Eight 4-wire ports
 - Port 8 is dedicated to program feed and stage announce
- Four 2-wire ports (Clear-Com or RTS)

The secure browser-based Core Configuration Manager (CCM) offers intuitive configuration and you also have the option of using the touch-sensitive front-panel screens.

You can connect the Base Station to:

- Wireless transceivers:
 - 1.9 GHz - E1 or IP connection
 - 2.4 GHz - E1 only
 - 5 GHz - IP only
- 2-wire partyline systems such as Encore
- Dante compliant systems

System limits:

- 100 channels
- 100 groups
- 200 roles

1.2 FreeSpeak Edge Base Station Interconnections

The following graphic shows an overview of how the FreeSpeak Edge Base Station can interconnect with other intercom components.

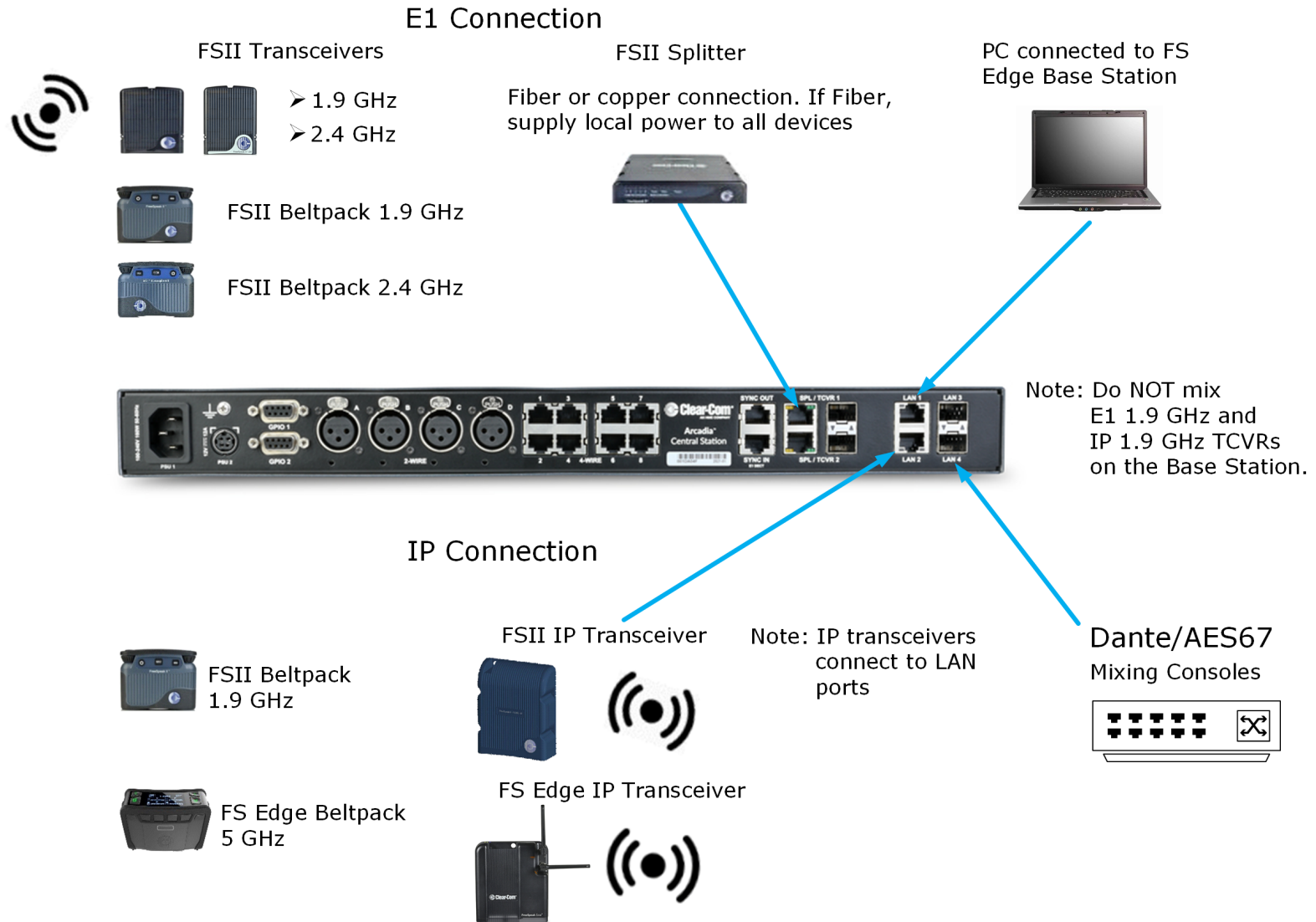

2 Installing FreeSpeak Edge Base Station

This chapter describes the front and rear panels, power supplies and cabling recommendations. It also describes network setup and illustrates example applications. It contains the following sections:

2.1 Front Panel Connectors, Controls and Indicators	11
2.2 Intercom Touchscreens	12
2.3 Rear Panel Connectors and Indicators	15
2.4 System Power	16
2.5 Clear-Com Ethernet Cable Recommendations	18
2.6 Stage Announce and Program Audio	18
2.7 Setting the Management IP Address	19
2.8 Saving and Restoring System Configuration	20
2.9 Resetting to Default	21

2.1 Front Panel Connectors, Controls and Indicators

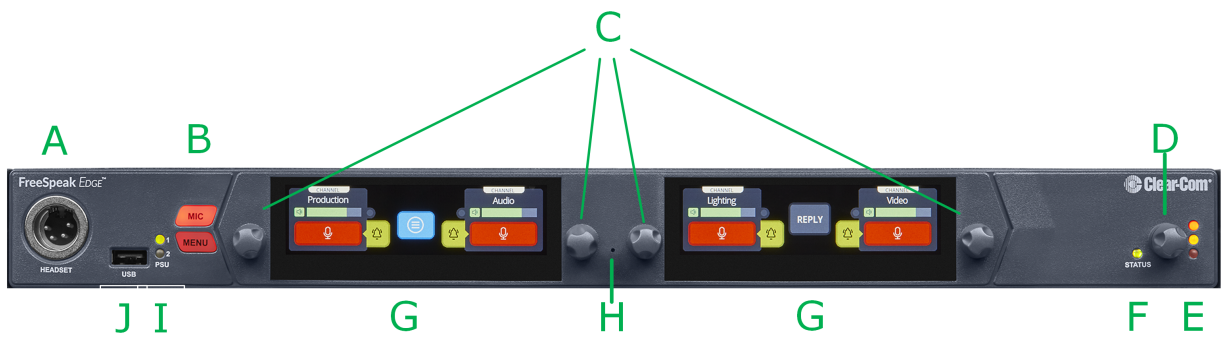

The FreeSpeak Edge front panel connectors, controls and indicators are listed below.

Item	Description
A	Headset connector (4-pin XLR female)
B	Microphone key Menu key
C	Rotary Encoders. Use these to control channel volume, mute or unmute audio, or to navigate through the menu system.
D	Main Volume Control
E	Main Volume Level LEDs: <ul style="list-style-type: none"> • Red - high volume level • Amber - medium volume level • Green - low volume level
F	Base Station status LED <ul style="list-style-type: none"> • Off - the device is off or initializing. • On (solid green) - All ok with the device. • Flashing green (slow, 2 Hz) - there are warning(s) with the device. • Flashing green (fast, 4 Hz) - there are error(s) with the device.
G	Color touchscreen displays
H	Pin reset

Item	Description
I	Power Input LEDs
J	USB A connector. Use to: <ul style="list-style-type: none"> • Register backpacks • Upgrade the Base Station • Save/Restore system settings • Obtain detailed logs for diagnostic purposes

2.2 Intercom Touchscreens

The Base Station has two intercom control touchscreens, available when the front panel screens are not in menu mode. Each touchscreen provides access to two keys which can be configured for channels, groups or point to point communications channels.

2.2.1 Left Intercom Touchscreen

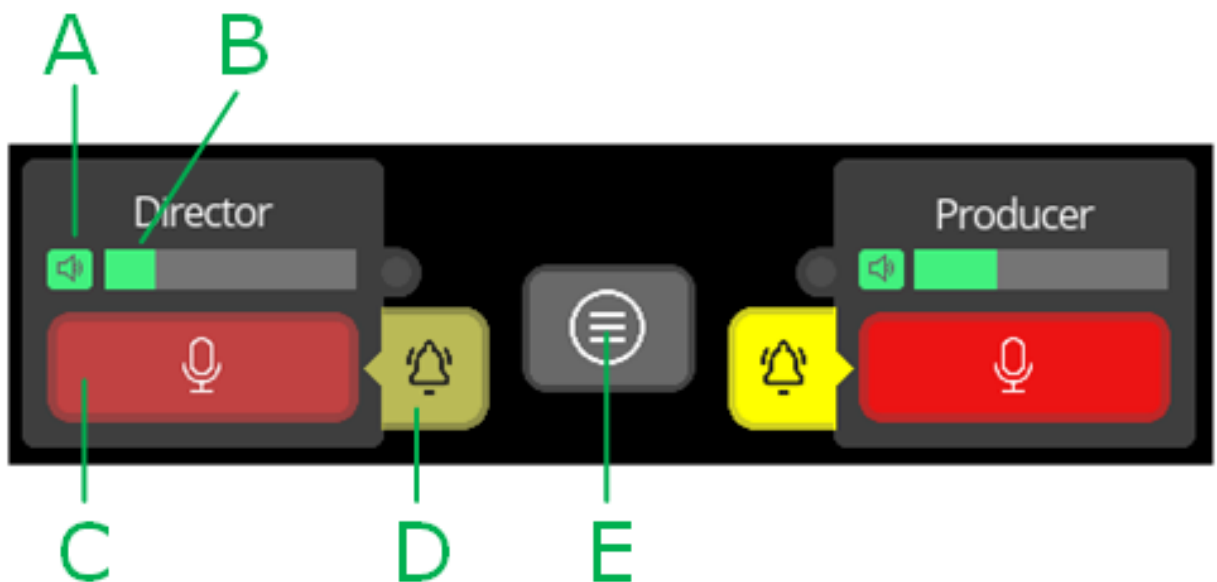

Item	Description
A	Listen activation indicator.
B	Volume level indicator. Control the volume with the rotary controller next to the channel/audio source.
C	Talk button.
D	Call button. Use this to send a call signal.
E	Menu button. Touch to see: <ul style="list-style-type: none"> • Stage Announce • All talk • Remote mic kill (RMK)

2.2.2 Right Intercom Touchscreen

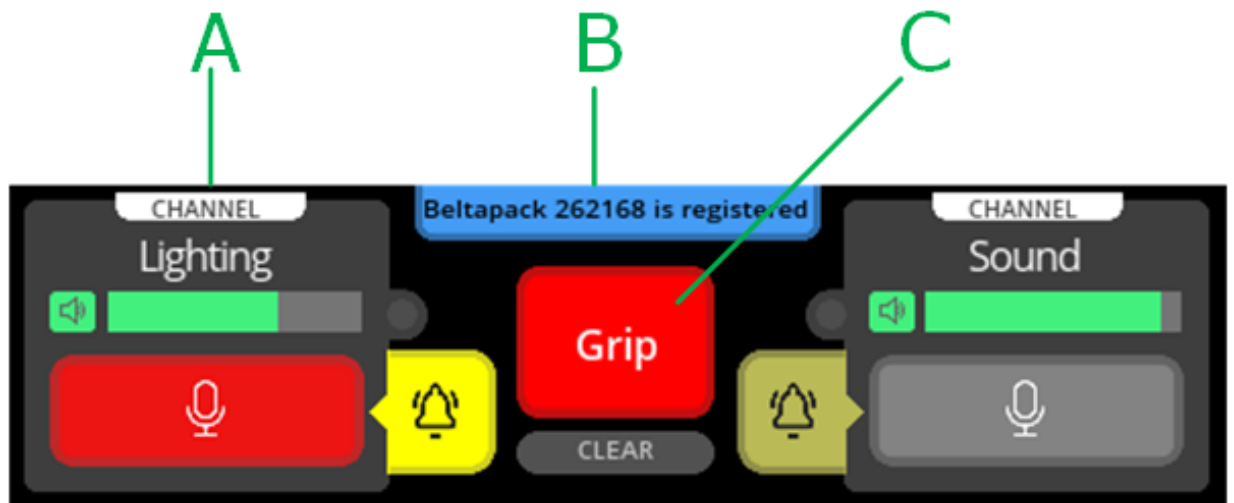

Item	Description
A	Channel indication. Audio routes can be point-to-point or channels.
B	Notification bar <ul data-bbox="779 378 1266 609" style="list-style-type: none">• Beltpack registration• Progress of upgrades• Support information gathering• Resoration of configuration progress
C	Reply button. Use CLEAR to clear the currently visible entry (does not clear the entire key stack).

2.3 Rear Panel Connectors and Indicators

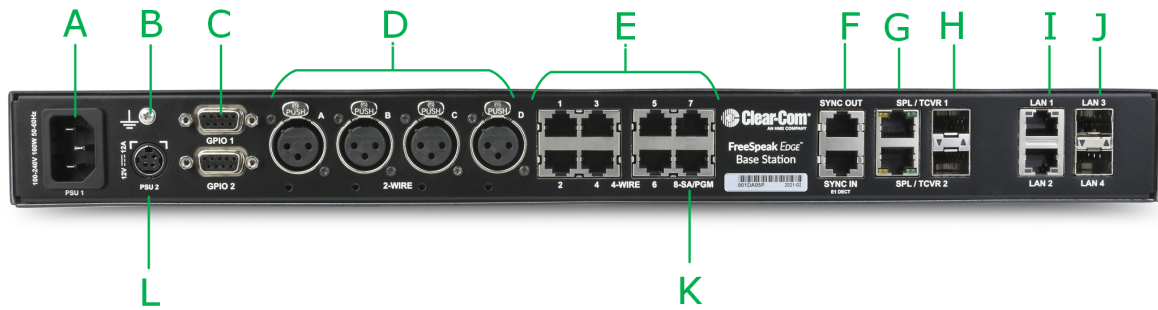

The rear connectors and indicators are listed below.

Item	Description
A	Internal power connector. Mains power lead with internal power supply.
B	Grounding screw.
C	General Purpose Input/Output connectors x2 (DB-9F). <ul style="list-style-type: none"> GPIO 1 contains GPI1 and GPO1 & 2 GPIO 2 contains GPI2 and GPO 3 & 4.
D	XLR 2-wire Partyline connectors
E	RJ45 4-wire audio and data connectors. Port 8 is dedicated to Program Feed (PGM) and Stage Announce (SA), to be used with the split RJ45 cable connector that is supplied with the Base Station.
F	Dect Sync RJ45 connectors, IN, OUT.
G	E1 RJ45 connectors to splitter/transceiver. Do not connect IP transceivers here.
H	SFP cage for E1 fiber connection to splitter/transceiver. Either single-mode or multi-mode fiber modules. Modules must match existing cabling. Do not connect IP transceivers here. Connections to splitters can be Ethernet, Fiber, or a combination of both. If you use Fiber cable, you must set the port to a Fiber connection (default is RJ45) in the CCM (CCM > Host > Wireless > Wireless Transceivers).
I	RJ45 LAN connectors. IP transceivers, the configuration PC and Dante are connected here. Capacity 1Gb.
J	SFP cage for fiber LAN connectors. Capacity 2.5Gb.

Item	Description
K	SA/PGM. RJ45 for SA and RJ45 to XLR for PGM.
L	External power supply connector (12V DC). CAUTION: Before using, see System Power on page 16 .

2.4 System Power

FSEBase Station features dual power inputs:

- Mains power connector (IEC) internal power supply
- DC connector. External AC/DC power adapter (12V DC, 12A)

Both power inputs can be connected in parallel for redundancy.

2.4.1 Using the External DC Power Connector

CAUTION: YOU MUST CONNECT THE EXTERNAL DC POWER SUPPLY IN THE ORDER DESCRIBED AND ILLUSTRATED BELOW:

1. Connect the external power supply 12V cable connector (A) to the rear chassis 12V input connector of the Station.

Note: When connecting the power cable, be sure to push until the connector locks into the device.

Station (rear, left-side)



2. Connect External Power Supply mains cord (B) to the AC input source.

Mains connector

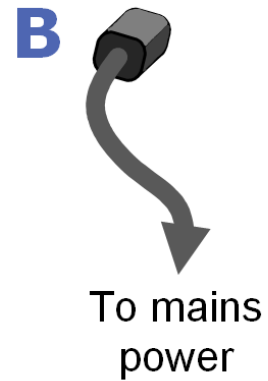

2.5 Clear-Com Ethernet Cable Recommendations

Cable recommendations	
Category (Cat)	<p>Higher Cat numbers will support a higher bandwidth. Therefore, by using a higher Cat number you are future proofing your system to some extent. Example:</p> <ul style="list-style-type: none"> • Cat 5e : up to 1 GB • Cat 6: up to 10 GB <p>Use Cat 5e or higher.</p>
American Wire Gauge (AWG)	<p>The lower the AWG number, the less temperature rise there will be in the cable when using PoE. This is particularly important for bundles. Local building regulations may rule out the use of 26 AWG or higher, depending on the installation. Check with your local building regulations. Use AWG 24 or lower.</p>
Shielded Twisted Pair (STP) or Foiled Twisted Pair (FTP)	<p>Using shielded cable means less problems with interference from other sources. This means that your installation will be more robust if you use shielded cables.</p>

Note: Overall recommendation: Use Cat 6a, 23 AWG STP cable.

2.6 Stage Announce and Program Audio



Your FreeSpeak Edge Base Station is supplied with an RJ45 connector that uses a splitter cable to split into two XLR connectors. If you wish to use an external Stage Announce (**SA**) and

Program audio (**PGM**), you must connect this to the RJ45 port labeled **SA/PGM** (port 8) on the rear of your device, and connect your input (**PGM**) and output (**SA**) to these connectors.

- Stage announce (audio out): Male XLR
- Program feed (audio in): Female XLR

Navigate to **Configuration > Channels** in the CCM and click the add button  next to the PGM and SA ports to put them into channels as required. These audio resources can be routed with **Channels**, **Groups**, **Roles** and **Logic** events (GPIOs).

Note: *These resource are unidirectional (simplex, not duplex).*

2.7 Setting the Management IP Address

By default your Base Station works with DHCP. However, you can set a static IP address for any of the station Ethernet ports (with the exception of Dante audio that is defined by the Audinate Dante Controller).

The Management IP address can be set:

- From the Base Station front panel menus
- From the CCM

2.7.1 Setting the Management IP Address from the Front Panel Menus

1. Press the **MENU** button.
2. Using the far left rotary controller, navigate to **Networking**.
3. Select **Management**.
4. Navigate to **DHCP** and select **DISABLED**. Push to select menu item.
5. A numerical touchscreen keypad appears in the screen.
6. Using the touchscreen, press **Clr** to clear the IP address field.
7. Enter the new IP address using the touchscreen.
8. Press **OK**.
9. Edit the subnet if required.
10. Press **OK**.
11. The Management IP address has been changed.

For more information, see [LAN Configuration Rules on page 89](#).

2.8 Saving and Restoring System Configuration

Clear-Com recommends that you make a backup of your system configuration using the Save option that is available in the CCM and the front panel menu system.

2.8.1 Saving System Configuration in the CCM

The **Save** and **Restore** options are available in the CCM top navigation bar.



When you click **Save**, all system configuration; channels, roles and network details are saved to a file (.cca) on your computer.

2.8.2 Saving System Setup in the Front Panel Menus

1. Insert a USB drive into the USB connector on the front of the Base Station.
2. Press the **Menu** button.
3. Using the rotary controllers, navigate to **Administration > Settings > Save**.
4. Push the 4th rotary controller. System setting are saved to the USB drive. The progress of this Save is shown in the notification bar on the front panel.

2.8.3 Restoring System Configuration

Your system configuration can be restored to the Base Station at any time using the **Restore** button in the CCM and also from the front panel menu system.

On restore, the saved configuration is reapplied to the Base Station. The following aspects of the configuration are optionally restored:

- Network settings (IP addresses)
- Over The Air system ID.

You do not get these options when restoring by USB directly to the Base Station. If you want to restore system settings taken from different Stations, you must use the CCM Restore option, as restoring directly from the Base Station in this situation would restore network and OTA system ID and IP and could cause wireless ID conflicts.

2.9 Resetting to Default

Your Base Station can be reset to default settings either from the front panel menus or from the Core Configuration Manager (CCM).

Note: *When you use a pin reset on front the front of the Base Station the device reboots.*

2.9.1 Resetting to Default from the Base Station Menu System

1. Press the **Menu** button on the front of the Base Station.
2. Using the rotary controllers navigate to **Administration > Reset > Reset to Default > Reset Base**.
3. Press the 4th rotary controller.
4. The device will reset to factory defaults and reboot.
Network settings are also reset, and the password is reset to default.

2.9.2 Resetting to Default from the CCM

1. In the CCM, navigate to **Status > Overview > Host Device**.
2. Select **Reset to Default**.
3. From the confirmation dialog box, click **Reset to Default**.
4. The device will reset to factory defaults and reboot.
Network settings are not reset, and the password is also not reset.

3

Configuring from the Front Panel

This chapter describes how to configure the FreeSpeak Edge Base Station from the front panel. It contains the following sections:

3.1 Introduction to Configuring from the Front Panel	23
3.2 Setting the Management IP Address	23
3.3 Passwords, IP Addresses, Reset to Default, Save and Restore Configuration	24
3.4 Front Panel Menus	27

3.1 Introduction to Configuring from the Front Panel

Some common tasks you might perform from the front panel menus are:

- See/configure the Base Station IP address
- See the default CCM password
- Null your 2-wire audio ports
- Reset the Base Station to factory settings
- Reset the CCM password

To enter the Base Station menu system, press the **Menu** button on the front panel. Navigate through the hierarchical menu using the rotary controllers. To select or commit a menu item, press the rotary encoder next to it.

To exit the menu system, press the Menu button again, or leave the device to time-out of menu mode (20 seconds).

3.2 Setting the Management IP Address

By default your Base Station works with DHCP. However, you can set a static IP address for any of the station Ethernet ports (with the exception of Dante audio that is defined by the Audinate Dante Controller).

The Management IP address can be set:

- From the Base Station front panel menus
- From the CCM

3.2.1 Setting the Management IP Address from the Front Panel Menus

1. Press the **MENU** button.
2. Using the far left rotary controller, navigate to **Networking**.
3. Select **Management**.
4. Navigate to **DHCP** and select **DISABLED**. Push to select menu item.
5. A numerical touchscreen keypad appears in the screen.
6. Using the touchscreen, press **Clr** to clear the IP address field.
7. Enter the new IP address using the touchscreen.
8. Press **OK**.
9. Edit the subnet if required.
10. Press **OK**.
11. The Management IP address has been changed.

For more information, see [LAN Configuration Rules on page 89](#).

3.3 Passwords, IP Addresses, Reset to Default, Save and Restore Configuration

You can find the Base Station IP address, manage the CCM password and reset to default settings.

3.3.1 Find the Base Station IP Address

1. Press the **Menu** button on the front of the Base Station.
2. Navigate to **Networking > Management > IP Address** using the rotary controllers.
3. You will see the device IP address.



3.3.2 Find the default password for the CCM

1. Press the **Menu** button on the front of the Base Station.
2. Navigate to **Administration > CCM Access > Default Password** using the rotary controllers.
3. You will see the default password in the right hand menu screen.

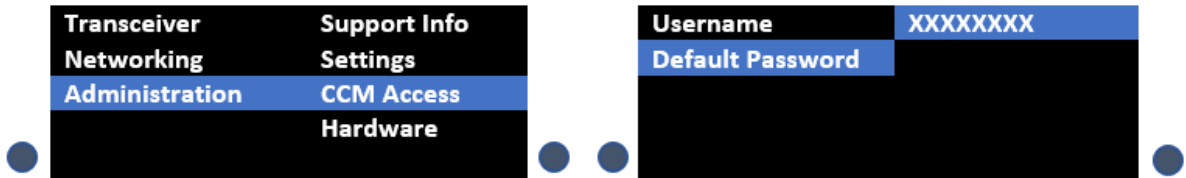

3.3.3 Reset the device to default settings

1. Press the **Menu** button on the front of the Base Station.
2. Navigate to **Administration > Reset > Reset To Default > Reset Base**.
3. The Base Station will reset to factory settings.

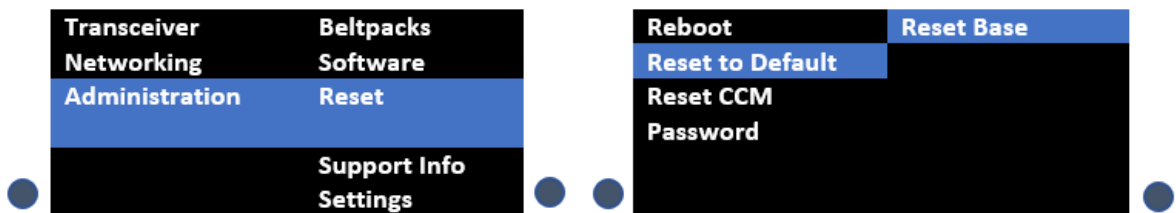

Note: When you use a pin reset on front the front of the Base Station the device power cycles.

Note: When resetting the Base Station to default settings using the front panel menu system, all the system configuration details, including network settings are reset. The management IP of the Base Station will change.

Note: When you reset the Base Station to default settings, you must **Add** the IP transceivers to the system again. See [Adding IP Transceivers on page 55](#).

3.3.4 Reset the CCM password

1. Press the **Menu** button on the front of the Base Station.
2. Using the right hand rotary controller select **Administration > Reset > Reset CCM Pass.**
3. Press the right hand rotary controller.
4. The password will reset to its default setting.

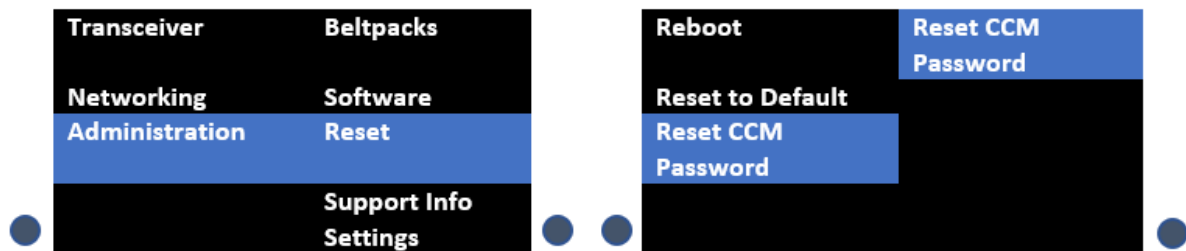

3.3.5 Save/Restore System Setup

1. Insert a USB drive into the USB connector on the front of the Base Station.
2. Press the **Menu** button.
3. Using the rotary controllers, navigate to **Administration > Settings > Save.**
4. Push the 4th rotary controller. System settings are saved to the USB drive. The progress of this Save is shown in the notification bar on the front panel.
5. The file is saved in a folder called **/backupConfig/** in the USB. The file name format is **hostNameDateTime.cca.**

Note: *When you restore system settings in the CCM, Network and OTA System ID settings are optional. When you restore system settings from the front panel all settings are recalled which may cause system conflicts, unless you are intending to configure a cold standby Arcadia unit.*

3.4 Front Panel Menus

The front panel menu options are listed below.

3.4.1 Audio Settings

Headset

- **Headset Limit.** This allows the user to set the headset limiter for the front panel headset.
 - -12 dB to +8 dB/ OFF
- **Headset Detect**
 - Enabled (default)
 - Disabled
- **HS Mic Type**
 - Dynamic (default)
 - Electret
- **Sidetone Gain**
 - -12 dB to +8 dB (-12 dB default)
- **Sidetone Control**
 - Tracking (default)
 - Non-Tracking
 - Disabled

Gooseneck

- Electret
- Dynamic

3.4.2 Host Settings

Host Name. Pushing the fourth rotary will open the on screen keyboard to allow the user to enter a new name for the device (touchscreen). [OK] when done.

Display

- Screen Brightness. High, Medium (default), Low, Very Low
- Screen Dimming. The screen will dim to Very Low when there is no activity. Timeout time: 1,2 (default),3,5,10 or 15 minutes.
- Touchscreen sensitivity: Low, Medium (default), High.

3.4.3 2W Audio (A,B)

Configure power settings for 2-wire audio sources and perform nulling.

- Interface - power settings
 - Power detected? Yes/No
 - Power Enabled/Disabled (default = disabled)
 - Mode Clear-Com/RTS (default = Clear-Com)
- Nulling: 2W A and 2W B. Press the rotary control (Start) to perform a null. Nulling is only available if power is detected.

3.4.4 2W Audio (C,D)

See 2W Audio (A,B)

3.4.5 Discovery

- Discover FSII TCVR.
 - Lists all FSII IP transceivers visible on the network. Select the transceiver you wish to register (third rotary). Select **Register** and push the rotary (fourth rotary) to begin the connection sequence.
- Discover FSE TCVR.
 - Lists all FS Edge transceivers visible on the network. Select the transceiver you wish to register (third rotary). Select **Register** and push the rotary (fourth rotary) to begin the connection sequence.

Deregister will remove the transceiver from the system. You will only see the **Deregister** option if the transceiver has been already registered.

3.4.6 Transceiver

Lists all registered transceivers. You can view and edit **Label** and **Cable Comp (E1 only)** here. Pushing the fourth rotary will open the onscreen keyboard (touchscreen). [**OK**] when done.

Note: *Cable Comp is the same as Cable Length Offset.*

- FSII IP. Version, Label.
- FS Edge. Version, Label.
- FSII E1. Version , Label, Cable Comp.

3.4.7 Networking

Management

Configure and view:

- LAN Port Assignment
- DHCP **Enabled**/Disabled
- IP Address (read only when DHCP is Enabled)
- Subnet Mask (read only when DHCP is Enabled)
- MAC Address (read only)

Push the fourth rotary to open the on screen touchscreen keyboard to change IP and Subnet. [OK] when done. The keyboard is only available when DHCP is disabled.

Note: *When changing from DHCP **Enabled** to DHCP **Disabled**, the address previously assigned by the DHCP server will be set as the static address. This can cause IP conflicts so you must change the address to one not provisioned by the DHCP server.*

AES67 (for IP transceivers and AES67 panels)

The section of the menu is read only and only shown if the AES67 connection has been configured with a LAN port from the CCM. It shows:

- LAN Port Assignment
- DHCP Enabled/Disabled
- IP Address
- Subnet Mask
- MAC Address

Dante

The section of the menu is read only and only shown if the Dante connection has been configured with a LAN port from the CCM. It shows:

- LAN Port Assignment
- IP Address
- Subnet Mask
- MAC Address

3.4.8 Administration

- Beltpacks
 - Over the Air: Press rotary four to **Start OTA**. Put the Base Station in pairing mode for OTA registration of beltpacks (600 seconds).
 - BP Role List Sorting:
 - Role Number
 - Alphabetical
 - Battery type: use this setting if the beltpacks are not using the supplied Li-ion batteries.
 - Alkaline (default)
 - NiMh (for use in high pressure environments)
- Software
 - Current version
 - Update software from a file on a USB (insert into USB on front of Base Station)
- Connections - current connected ports on this Base Station
- Licensed Ports
 - Total Ports
 - Wireless Ports
 - Dante
 - Any Ports. Licensed ports can be allocated to Wireless, Dante or Any. This is a way to control your system resources. A port allocated to Wireless (for example) will not accept connections of any other type. Ports are able to accept all connections by default (Any). Port type is assigned in the CCM:
CCM > Hardware > Resources > Licensed Ports > Type.
- Reset
 - Reboot
 - Reset to Default. Reset here will reset role, channel and network details. You will need to **Add** your transceivers back into the system after reset.
 - Reset CCM Password
- Support Info

- Settings
 - Save
 - Restore
- CCM Access
 - Username
 - Default password
- Hardware (view only)

Information is for troubleshooting purposes only. Please note: the serial number in this section is the electronic main board serial number, not the device serial number.

4

The Core Configuration Manager (CCM)

This chapter describes the main pages of the Core Configuration Manager (CCM). It contains the following sections:

4.1 Changing the CCM Password	34
4.2 Hardware Page Overview	34
4.3 Configuration Page Overview	36
4.4 Status Page	40

4.1 Changing the CCM Password

Change the password to one of your own choosing in the top right corner of the navigation bar.

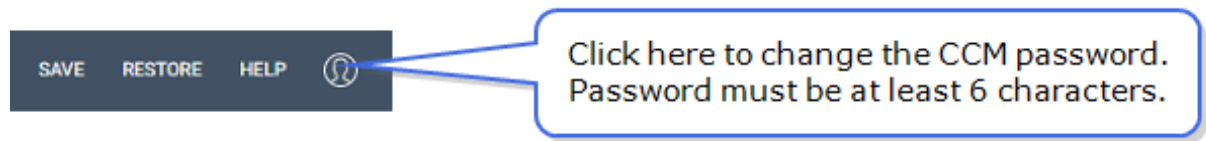

Note: You can reset your password to the default at any time from the Base Station front panel menus.

4.2 Hardware Page Overview

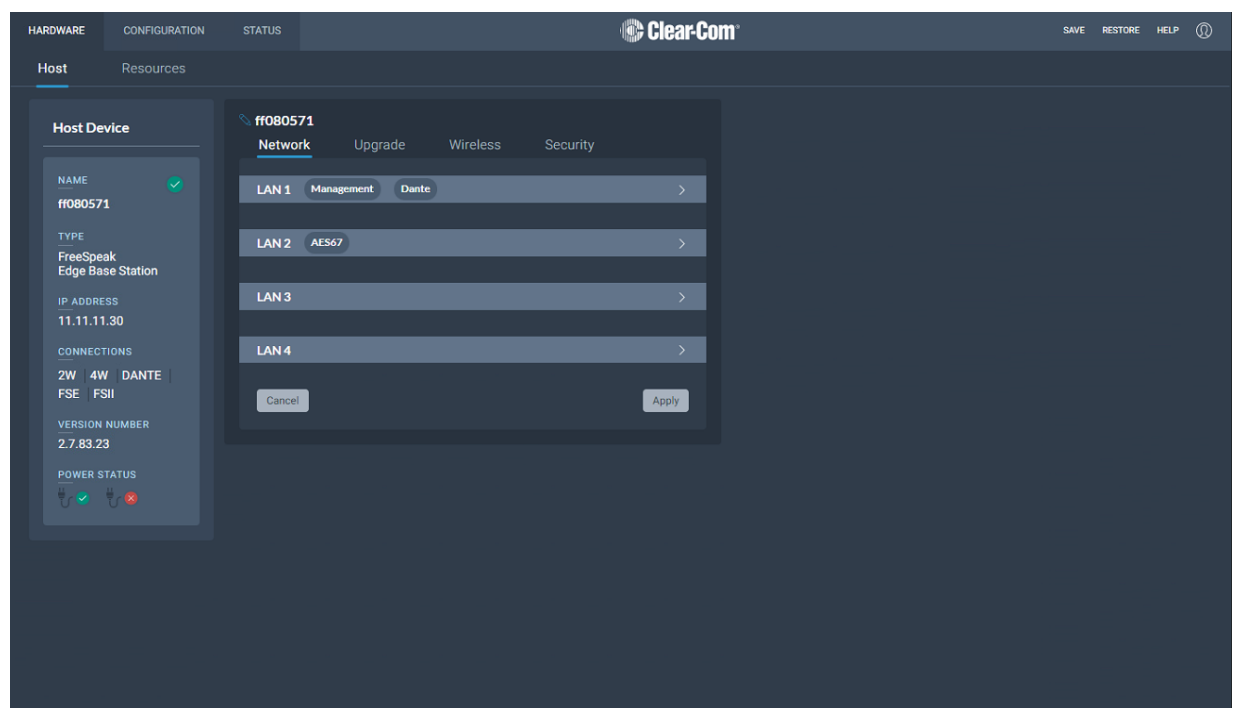

The Hardware page of the CCM is where you set up your system. From the **Hosts** tab you can configure your Station settings.

The Resources Page

Click the **Resources** tab to see the resources page. This gives an overview of the hardware and ports that are present. From this page, you can use the **Add Resource** button to:

- View a list of both discovered and registered IP transceivers
- Add any discovered IP transceivers to the system
- Remove any registered IP transceivers from the system
- Register beltpacks to the system
- Create Dante ports

In the Hardware Resources page you can:

- Adjust settings on interface ports

If you click the down arrow in the **Endpoints** section of the screen you will see a list of connected Endpoints. Select an Endpoint (beltpack) to show configuration details such as:

- Fix/unfix a role. If a role is fixed to a beltpack, the user cannot select from a list of roles on powering on the beltpack.
- Unregister a beltpack from the system.

The screenshot displays the Clear-Com Resources page. The top navigation bar includes 'HARDWARE', 'CONFIGURATION', and 'STATUS' (with a warning icon and '1'). The main header shows 'Host' and 'Resources'. A prominent 'Add Resource' button is visible. The 'Host Device' section on the left lists details for device #080571, including its type (FreeSpeak Edge Base Station), IP address (11.11.11.30), connections (2W, 4W, DANTE, FSE, PSII), version number (2.7.83.25), and power status. The main content area is divided into several sections: 'Transceivers' (1/11 ONLINE), 'Endpoints' (1/1 ONLINE) which contains a table with one entry, 'Physical Ports' (9/13 ONLINE), 'Dante Ports' (8/8 ONLINE), and 'Licensed Ports' (9/24 IN USE). A detailed configuration panel for 'EDGE-BP-525219' is open on the right, showing general settings like Type (FSE), Frequency Type (5.0 GHz), ID (0803a3), and Fixed Role (Non-fixed), as well as version (2.6.79.31) and maintenance options.

Status	Label	ID	Role	Type
✓	EDGE-BP-525219	0803a3	Director	FSE 5.0

4.3 Configuration Page Overview

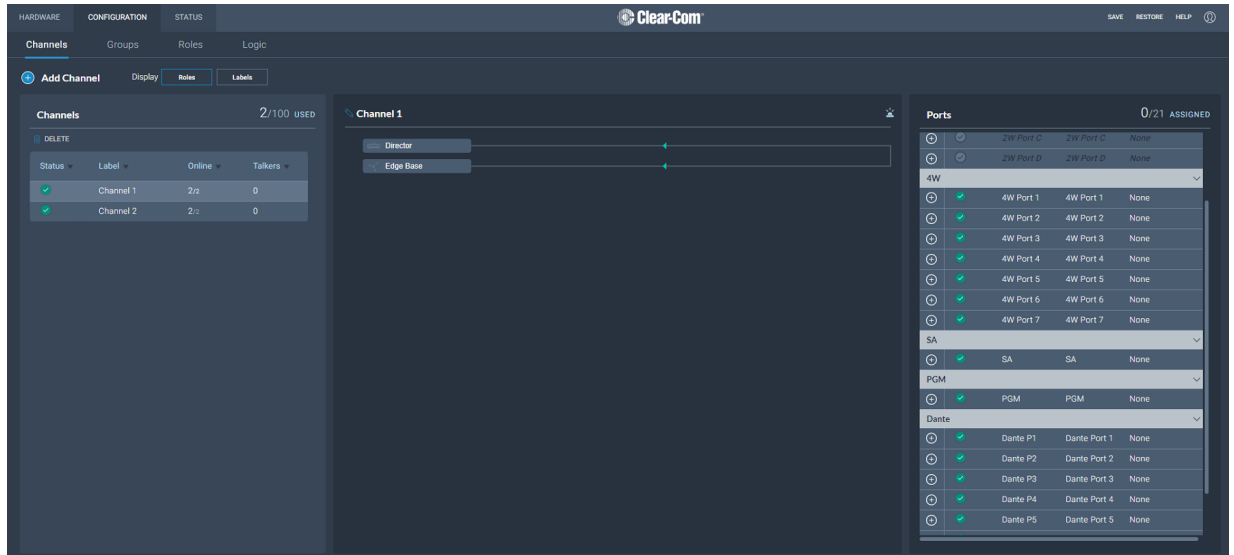

The **Configuration** page of the CCM is where you configure the intercom routing aspects of your system (add audio to channels and set up talk and call keys for beltpacks). It consists of four areas:

- Channels
- Roles
- Groups
- Logic (GPIOs)

The **Configuration** page enables you to:

- View existing channels and add new channels
- Add ports to channels
- View existing groups and add new groups
- View and edit roles
- View and edit General Purpose Inputs (GPIs) and General Purpose Outputs (GPOs)

4.3.1 Channels Page

The screenshot shows the Clear-Com Channels Page. At the top, there are tabs for HARDWARE, CONFIGURATION, and STATUS. The CONFIGURATION tab is active, with sub-tabs for Channels, Groups, Roles, and Logic. The Channels sub-tab is selected. On the left, there is a 'Channels' table with columns for Status, Label, Online, and Talkers. Two channels are listed: Channel 1 and Channel 2. The center panel shows 'Channel 1' with a live audio routing diagram featuring 'Director' and 'Edge Base' components. On the right, there is a 'Ports' section showing a list of ports assigned to Channel 1, including 2W, 4W, SA, PGM, and Dante ports.

The Channels page enables you to view channels and add ports to channels. Audio keys are added to channels in the **Roles** page. The center panel on this screen shows the live state of audio routing.

4.3.2 Groups Page

The screenshot shows the Clear-Com Groups Page. At the top, there are tabs for HARDWARE, CONFIGURATION, and STATUS. The CONFIGURATION tab is active, with sub-tabs for Channels, Groups, Roles, and Logic. The Groups sub-tab is selected. On the left, there is a 'Groups' table with columns for Status, Label, Online, and Talkers. One group is listed: Group 1. The center panel shows 'Group 1' with a live audio routing diagram featuring '4W Port 1' and 'SA' components. On the right, there is a 'Ports' section showing a list of ports assigned to Group 1, including 2W, 4W, and SA ports.

The Groups Page allows you to view Groups and add ports to Groups. Roles are added to Groups in the **Roles** page.

4.3.3 Roles Page

The **Roles** page enables you to create roles for the devices in your intercom system.

Roles are made for:

- The Edge Base Station
- FreeSpeak 4 key beltpacks (FreeSpeak II)
- FreeSpeak 8 key beltpacks (FreeSpeak Edge and FreeSpeak Icon)

An 8 key role can be used on either an Edge or an Icon beltpack. The role is used on one beltpack at a time.

Note: *FreeSpeak roles work on a 1:1 basis, each beltpack must have a unique role.*

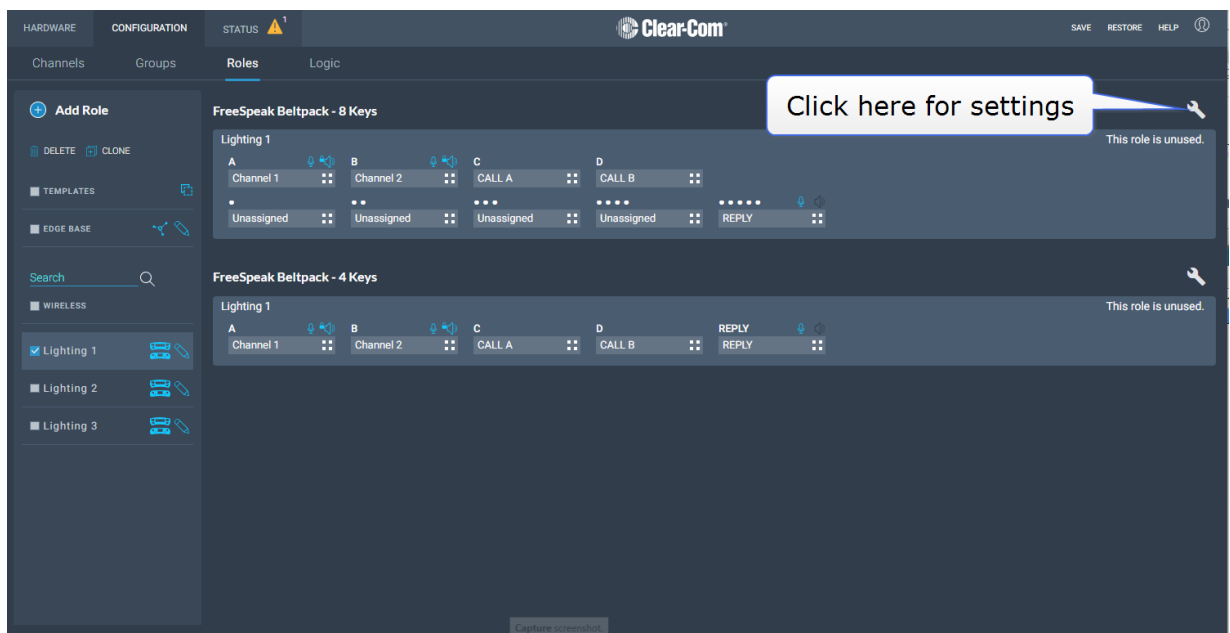

The **Roles** page of the CCM enables you to:

- View, add, clone, edit and delete roles.

4.3.4 Logic Page

The Base Station offers six fully configurable GPIOs, increasing the range and possible uses of controls and relays.

- 2 x GPIs. These can be used, for example, to allow the station operator to open an audio route to a Channel using a foot switch, or to route a program feed to a Channel, Group or beltpack when an on-air light comes on.
 - Up to 10 different audio routes can be generated on each GPI.
- 4 x GPOs. The most common uses for output relays are to turn on an on-air light, connect to a radio, or send an input to an external audio console.
 - Up to 10 different actions can be generated on each GPO.
- You can also set up extended control sequences in the **Control Logic** section.

Relays (GPOs) and GPIs are configured in the **Configuration > Logic** page of the Core Configuration Manager (CCM) and can be viewed and tested on the **Status > Logic** page.

The screenshot displays the Clear-Com Logic configuration interface. At the top, there are navigation tabs for HARDWARE, CONFIGURATION, and STATUS, with the CONFIGURATION tab selected. The sub-navigation includes Channels, Groups, Roles, and Logic. The main content area is titled 'Logic' and shows a '0/10 USED' indicator.

GPIO Configuration:

Status	Label
GPI	
1	GPI1
2	GPI2
GPO	
1	GPO1
2	GPO2
3	GPO3
4	GPO4

Crosspoints Events:

Source	Destination
Edge Base	SA

Control Logic:

Source	Destination	Action Type	Action Details
Director	2W Port A	Call	2W Port A receives call

4.4 Status Page

The screenshot shows the 'STATUS' page of the Clear-Com CCM. The top navigation bar includes 'HARDWARE', 'CONFIGURATION', and 'STATUS'. Below the navigation, there are tabs for 'Overview', 'Logic', and 'Event Log'. The main area displays a dashboard with various resource status indicators, including 'HOST DEVICE (1/1)', 'PHYSICAL PORTS (9/13)', 'DANTE PORTS (6/8)', 'TRANSCIVERS (2/12)', 'WIRELESS ENDPOINTS (2/3)', and 'WIRED ENDPOINTS (0/0)'. A legend on the right indicates status colors: offline (grey), online (green), initializing (blue), warning (yellow), and error (red). Below the dashboard, there is a 'Wireless' section with a 'Host Device' tab. A table lists connected devices with columns for Device Name, Role, Type, Battery, Signal, Keys, Vol., and a grid of status indicators for various transceivers (TCVR1-TCVR10) and endpoints (CC-TCVR-08XYF426, CC-EDGE-32250447). The table includes rows for FSII-BP-1064, EDGE-BP-525219, and EDGE-BP-324427.

From the **Status** page of the CCM, you can view the status of all the resources that are connected to the FreeSpeak Edge Base Station. These include:

- Transceivers (IP and E1)
- Beltpacks
- Interface ports

Here you will see error and warning states.

Note: *Error states are used exclusively to indicate that audio via this resource is not working.*

You can quickly see if entities are:

- Offline
- Online
- Initializing

5 Example Applications

This chapter contains examples of typical applications. It contains the following sections:

5.1 FreeSpeak Edge Base with FreeSpeak II Wireless - E1	42
5.2 FreeSpeak Edge Base with FreeSpeak II Wireless-E1 and Splitter	44
5.3 FreeSpeak Edge Base with FreeSpeak Edge IP Transceivers	46
5.4 Split Frequency Setup (5, 2.4 and 1.9 GHz System)	48

5.1 FreeSpeak Edge Base with FreeSpeak II Wireless - E1

The FreeSpeak II E1 transceivers use an E1 connection (telecommunications standard) directly to the Base Station. The Core Configuration Manager (CCM) is the easiest way to configure your system, but this setup can be configured with minimal use of the CCM if you work with the default role setup. Using the default setup, all devices have talk and forced listen keys to Channel 1 and Channel 2 and can engage call signals to those channels.

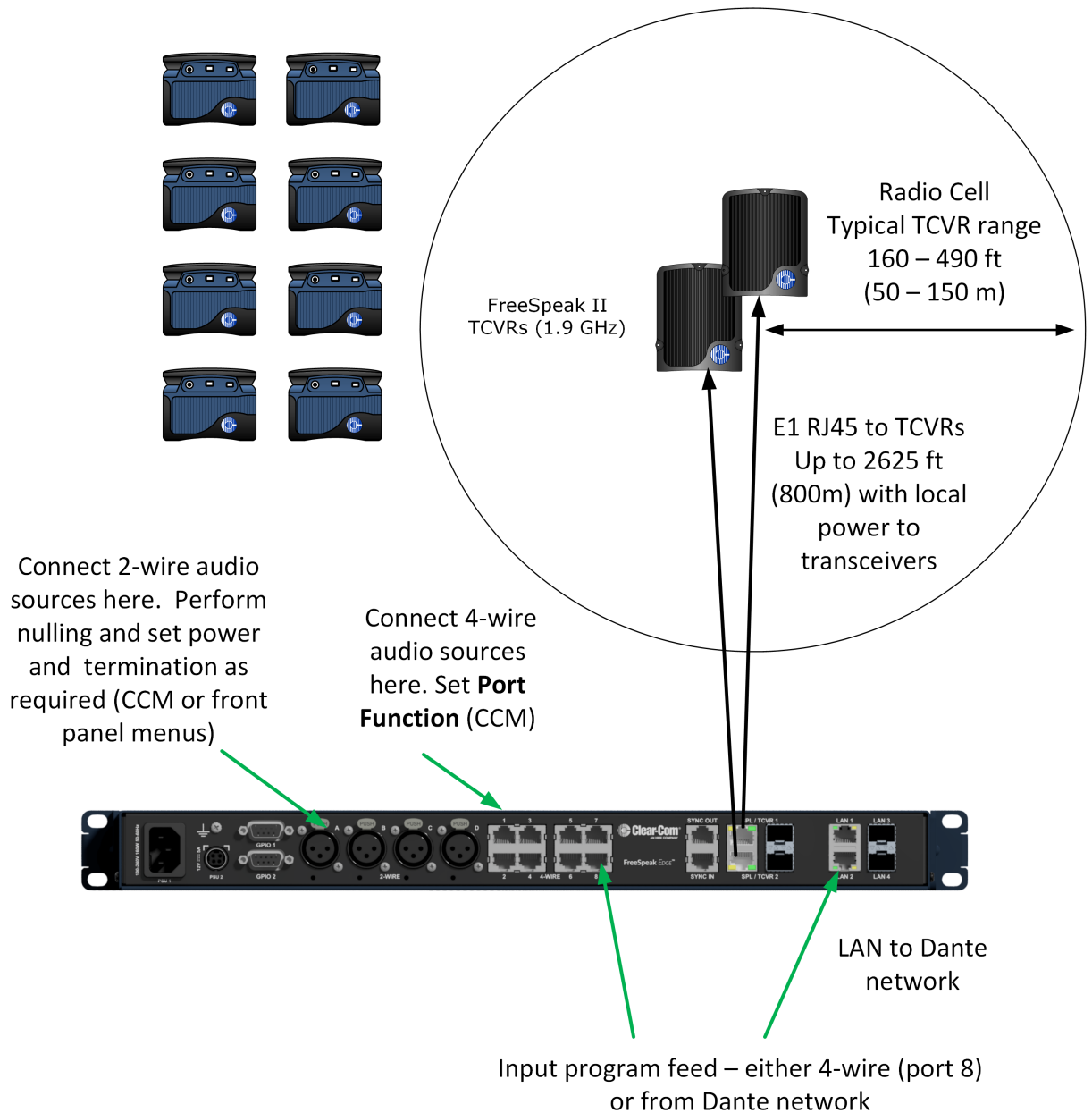

5.1.1 Outline of General Setup and Configuration

- For E1 setup, see [Connecting Transceivers Over E1 on page 50](#).
- To access the CCM, see: [The Core Configuration Manager \(CCM\) on page 33](#).
- To register beltpacks, see [Registering FreeSpeak Beltpacks on page 61](#).
- To set Port Function, see [Setting Port Function \(Pinout\) on a 4-Wire Connection on page 83](#).
- To perform null and set power, see [Using 2-Wire Systems on page 71](#).
- To connect Program Feed, see [Stage Announce and Program Audio on page 18](#)

5.2 FreeSpeak Edge Base with FreeSpeak II Wireless-E1 and Splitter

This setup includes two splitters, both connected via shielded Cat 5e cable using E1 connectivity. Four channels are configured in the CCM: Channel 1=ALL, Channel 2=Lighting, Channel 3=Sound, Channel 4=FoH. 16 roles are configured for the beltpacks.

There are four connectors on the rear of the device for splitters. Two splitters can be connected using Cat 5e cable or Fiber or a combination of Cat 5e and Fiber.

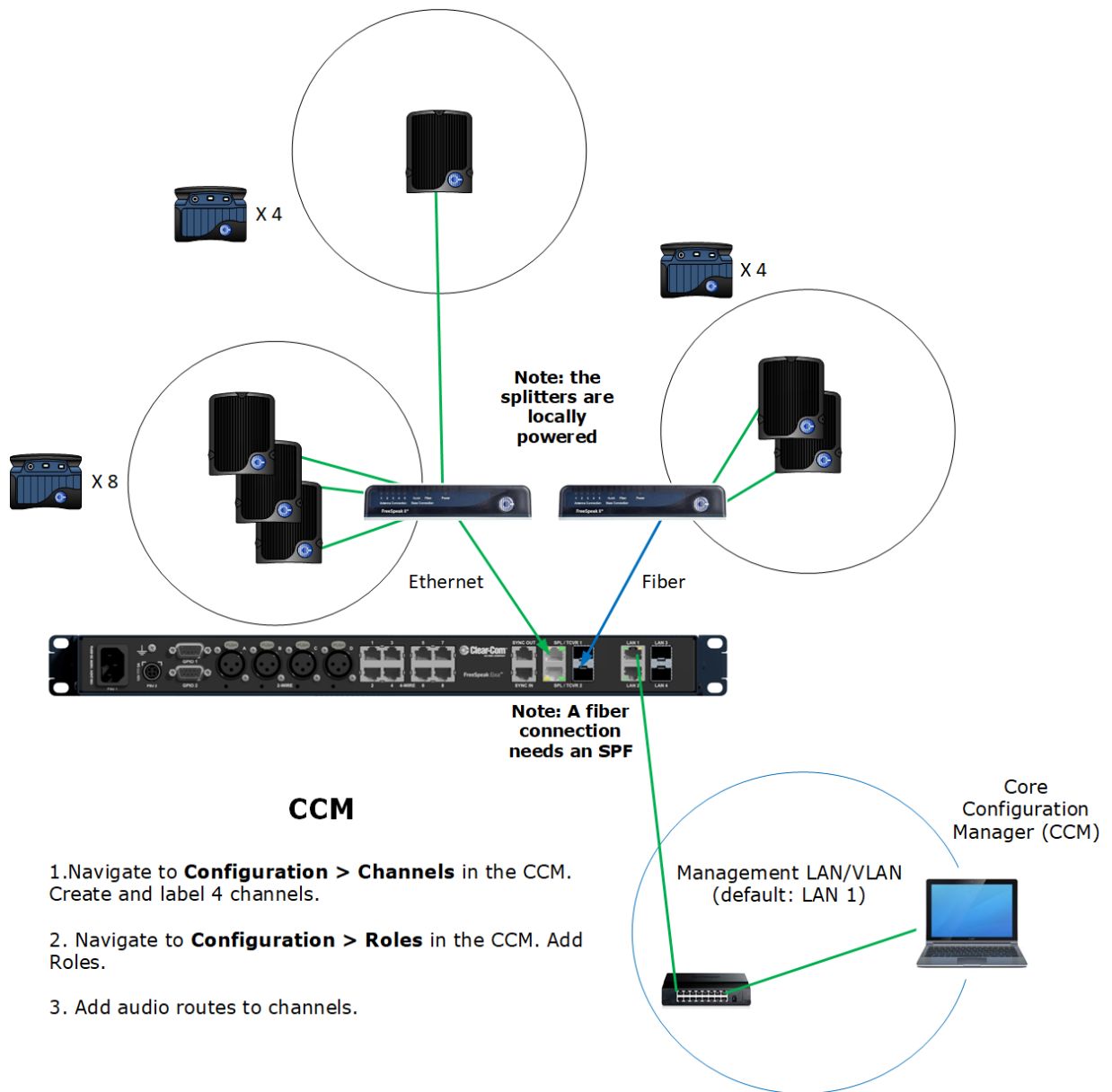

5.2.1 Outline of General Setup and Configuration

- For E1 setup, see [Connecting Transceivers Over E1 on page 50](#).
- To set the splitter DIP switches, see the FSII Splitter Quick Start Guide (FSII SPL-QSG) in the Clear-Com FreeSpeak II Knowledge Center on the Clear-Com website:
[Clear-Com FreeSpeak II Knowledge Center](#)
- To access the CCM, see [The Core Configuration Manager \(CCM\) on page 33](#).
- To register beltacks, see [Registering FreeSpeak Beltacks on page 61](#).
- To set port settings for 2-Wire sources, see [Using 2-Wire Systems on page 71](#).
- To set port settings for 4-Wire sources, see [Using 4-Wire Systems on page 76](#).
- To connect program and stage announce, see [Stage Announce and Program Audio on page 18](#).
- To configure channels, see: [Managing Channels on page 105](#).
- To configure Roles, see: [Managing Roles on page 116](#).

5.3 FreeSpeak Edge Base with FreeSpeak Edge IP Transceivers

This setup has a total of 6 FS Edge transceivers with 16 beltpacks. The transceivers are connected via a network that is configured for AES67 traffic. These are configured using the CCM. There are four 2-wire partylines and a Dante network.

Note: *The Dante network must be on a different VLAN or network from the IP transceivers.*

Note: *The AES67 network must be set up correctly for the IP transceivers in order to meet the needs of Clear-Com IP transceivers for high levels of PTP accuracy.*

See the *AoIP Network Recommendations* guide, available from the [Clear-Com FSII Knowledge Center](#).

FS Edge 5 GHz
beltpacks x 16

Register at the
Base or in the
CCM



Note: This setup assumes a dedicated network switch for the Edge Base, transceivers and CCM.

Note: You cannot configure the IP transceiver network (AES67) and Dante to the same network port.

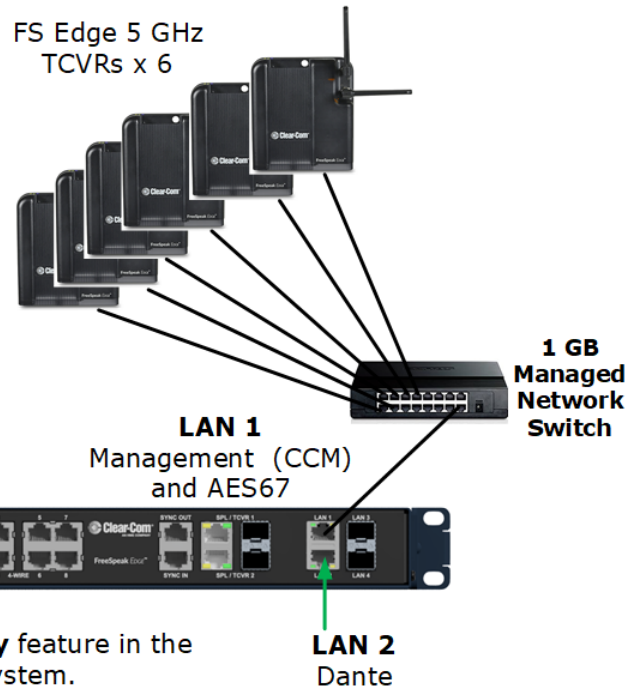

1. You will need to use the **Discovery** feature in the CCM to add IP transceivers to your system.

2. You will need to configure Dante feeds in the Audinate Dante Controller before these can be added to channels in the CCM.

Key
Cat5e/6a Shielded
Ethernet cable
23/24 AWG
(max 100m)

5.3.1 Outline of General Setup and Configuration

- For network setup, see [Network Setup for IP Transceivers on page 57](#).
- To access the CCM, see [The Core Configuration Manager \(CCM\) on page 33](#).
- To add IP transceivers to your system, see [Using FreeSpeak Wireless Intercom on page 49](#).
- For information on the connection process for IP transceivers, see the Quick Start Guides (QSGs) for FS Edge IP transceivers available from the [FreeSpeak Edge Knowledge Center](#).
- For information about connecting to 2-Wire systems, see: [Using 2-Wire Systems on page 71](#).
- For information about connecting to Dante, see: [Using Dante Systems on page 67](#).
- For information about Channels, see [Managing Channels on page 105](#).
- For information about Roles, see: [Managing Roles on page 116](#).

5.4 Split Frequency Setup (5, 2.4 and 1.9 GHz System)

This setup has:

- E1 FS II transceivers (1.9) with 5 beltpacks
- E1 FS II transceivers (2.4) with 4 beltpacks
- FS Edge IP transceivers (5) with 10 beltpacks
- FS II IP transceivers (1.9) with 10 beltpacks.

The E1 Transceivers will automatically connect to the Base Station once powered, but the Edge IP transceivers require additional configuration in the CCM and must be connected to a network that is configured for AES67 traffic.

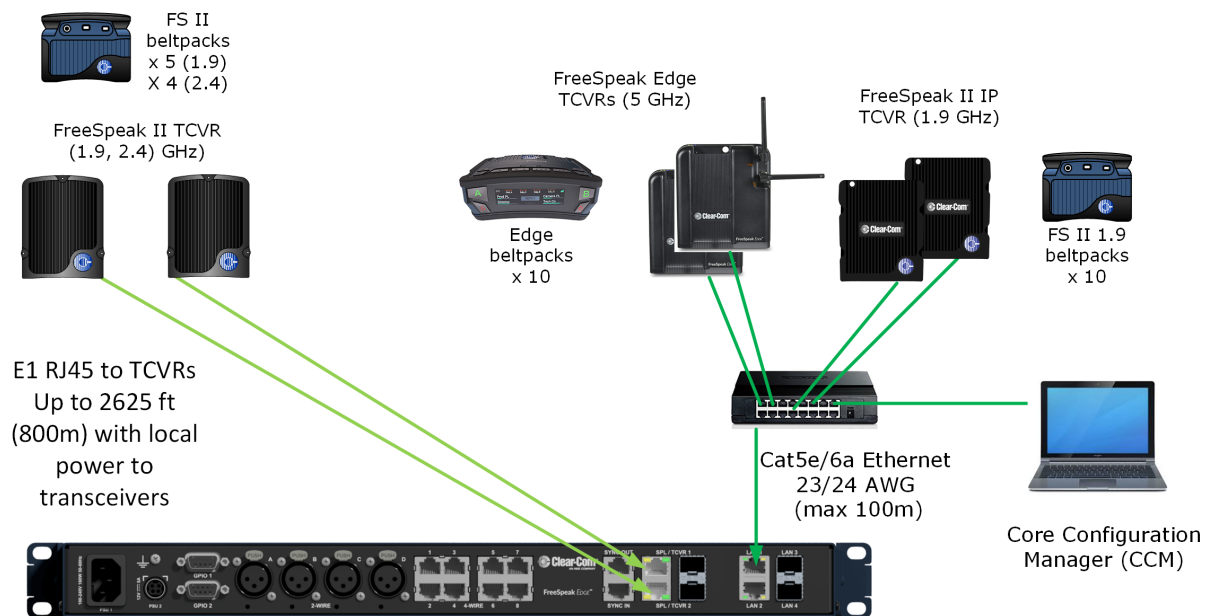

CCM Configuration

2 x Channels: Cameras, Lighting

16 x Roles: Director, Stage Manager, Runners, Maintenance, Lighting, Sound

Note: you can create roles that can be used by FS Edge and/or FS II beltpacks (the role can only be used by 1 beltpack at any given time).

6

Using FreeSpeak Wireless Intercom

This chapter describes how to connect to E1 and IP transceivers. It contains the following sections:

6.1 Overview of Transceivers	50
6.2 Connecting Transceivers Over E1	50
6.3 Adding IP Transceivers	55
6.4 Connecting Transceivers Over IP	56
6.5 Network Setup for IP Transceivers	57
6.6 Registering FreeSpeak Beltpacks	61
6.7 FS Edge Transceivers	64

6.1 Overview of Transceivers



6.2 Connecting Transceivers Over E1

E1 is a telecommunications standard whereby data and power are sent over Cat 5/6 or Fiber cable. E1 connections must have dedicated cabling as it is not possible to use network switches with this technology.

FreeSpeak II systems (1.9 and 2.4 GHz) can be connected to the Base Station using E1 connectivity.

Note: You must **not** place E1 1.9 GHz and IP 1.9 GHz transceivers from the same system in the same RF zone.

Transceivers can be connected directly to the Base Station (up to two transceivers) or connected using FreeSpeak II splitters (up to 2 splitters, each hosting up to 5 transceivers so up to 10 transceivers in total).

Transceivers/splitters are connected to the Base Station using connectors G and H. See [Rear Panel Connectors and Indicators on page 15](#)

Note: FreeSpeak II splitters can be connected using Fiber or Cat 5/6 cable. Configure the port in: **CCM > Host > Wireless > FreeSpeak II** (default = RJ45).

Note: FreeSpeak Icon beltpacks require E1 transceiver firmware v.3 or higher. Before registering FreeSpeak Icon beltpacks, download and install the latest 1.9 GHz E1 transceiver firmware from the Clear-Com website.

Example connection with a splitter



Note: The splitter connections are switched between RJ45 and Fiber routing using DIP switches inside the splitter.

For more examples of connection options and how to set the DIP switches, see the FreeSpeak II Splitter Quick Start Guide available from the [FreeSpeak II Knowledge Center](#).

6.2.1 Cable Distances - E1 Connections

Base Station to TCVR/splitter	
TCVR directly connected to and powered by the Base Station	<ul style="list-style-type: none"> • 328 ft (100 m) using shielded 24 AWG Cat 5/6e cable • 164 ft (50 m) using shielded 26 AWG Cat 5/6e cable
TCVR directly connected to the Base Station with local/direct power at TCVR	<ul style="list-style-type: none"> • 2625 ft (800 m) using shielded 24 AWG Cat 5/6e cable • 1312 ft (400 m) using shielded 26 AWG Cat 5/6e cable
Base Station to splitter (splitter is locally powered)	<ul style="list-style-type: none"> • 2625 ft (800 m) using shielded 24 AWG Cat 5/6e cable • 1312 ft (400 m) using shielded 26 AWG Cat 5/6e cable

Splitter to TCVRs	
TCVRs powered by splitter	<ul style="list-style-type: none"> • 328 ft (100 m) using shielded 24 AWG Cat 5/6e cable • 164 ft (50 m) using shielded 26 AWG Cat 5/6e cable
TCVRs have local/direct power	<ul style="list-style-type: none"> • 2625 ft (800 m) using shielded 24 AWG Cat 5/6e cable • 1312 ft (400 m) using shielded 26 AWG Cat 5/6e cable

Note: *Fiber connections: connection distances will depend on existing cable infrastructure.*

6.2.2 Using a Transceiver With a Fiber Connection

To connect a Base Station to a splitter (FSII-SPL) using Fiber, you must install Fiber modules to the Base Station and the splitter.

- Modules are available for single mode Fiber cable (SFP-SMFO-100M-LX or HLI-SMFO) and multi-mode Fiber cable (SFP-MMFO-100M-FX or HLI-MMFO).
- Modules must be ordered from Clear-Com as a pair, one for the Base Station and one for the splitter.
- Modules can be hot patched. There is no need to power off devices.
- To install the modules, simply remove the dust cap from the connector port and slide the module into the connector.

Note: *When using a Fiber connection, the splitter(s) must have local power supplied.*

6.2.3 E1 Transceiver/Splitter Port Connection Type (RJ45 or Fiber)

Transceivers/splitters can be connected to the Base Station using either RJ45 cable or fiber cable. You can have two RJ45 connections, two Fiber connections or one RJ45 and one Fiber.

The connection type for the ports is determined by a software setting in the Core Configuration Manager (CCM). Default setting is **RJ45**.

Setting FSII Transceiver/Splitter Connection Type

1. In the CCM, navigate to **Hardware > Hosts > Wireless**.
2. Select **FreeSpeak II > Transceiver Port** type as required.

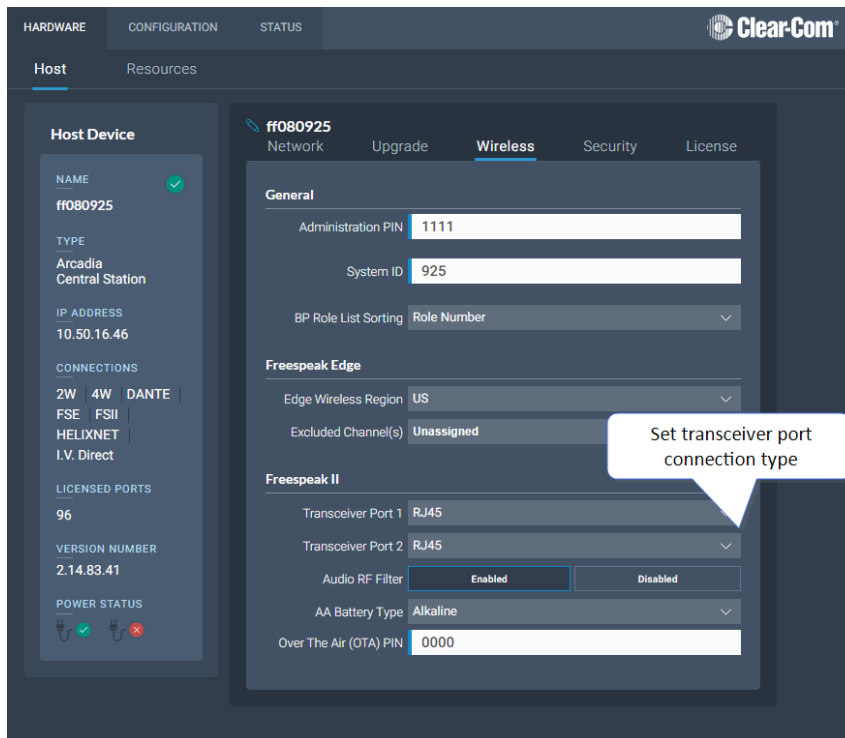

6.2.4 Audio RF Filter E1 Transceivers

An audio filter can be enabled or disabled for E1 1.9 GHz transceivers. This audio filter is designed to compensate for corrupted data in the wireless transmission. Default is **Disabled**.

To enable this setting, in the CCM go to: **Hardware > Host > Wireless > FreeSpeak II > Audio RF Filter**.

6.2.5 Setting Cable Length Offset (E1)

Cable length offset is used to optionally align the DECT or radio signals between transceivers. If transceivers are not synchronized, beltpack handover will not happen effectively. This is particularly important if you have overlapping transceiver coverage zones (RF cells) or the beltpacks need to move between coverage zones.

Cable length offset or transceiver sync compensation needs to be set when:

- The difference in total cable length between transceivers is $\geq 1640\text{ft} / 500\text{m}$ (this includes both fiber and copper cable runs).

Example

TCVR #1: total cable length = 328ft / 100m

TCVR #2: total cable length = 2788ft / 850m

The difference in cable length between transceivers = 2460ft / 750m. Therefore, in this case you must set transceiver cable length on both transceivers. This allows any latency to be calculated and offset by the system.

The screenshot shows the Clear-Com configuration tool interface. The top navigation bar includes 'HARDWARE', 'CONFIGURATION', and 'STATUS'. The main content area is titled 'Resources' and shows a list of transceivers. A callout box labeled '1. View transceivers' points to the list. A second callout box labeled '2. Select transceiver' points to the 'TCVR1' entry in the list. A third callout box labeled '3. Set cable compensation' points to the 'Cable Length' field in the 'TCVR1 Details' panel, which is set to '6-69m'. The 'TCVR1 Details' panel also shows 'Model: FSII', 'Transport: E1', and 'Version: Unknown'.

Name	Type	Usage
CC-EDGE-37256734	FSII-IP-S.0	0/10
CC-TCVR-08XYF426	FSII-E1.9	0/10
TCVR1	FSII-E1	
TCVR2	FSII-E1	
TCVR3	FSII-E1	
TCVR4	FSII-E1	
TCVR5	FSII-E1	
TCVR6	FSII-E1	
TCVR7	FSII-E1	
TCVR8	FSII-E1	
TCVR9	FSII-E1	
TCVR10	FSII-E1	

In the configuration tool, navigate to: **Resources > Transceivers > Details > General > Cable Length**

6.3 Adding IP Transceivers

Note: To add E1 transceivers, see [Connecting Transceivers Over E1 on page 50](#).

To add IP transceivers:

1. Navigate to **Hardware > Resources** and select **Add Resource**. The following screen appears.

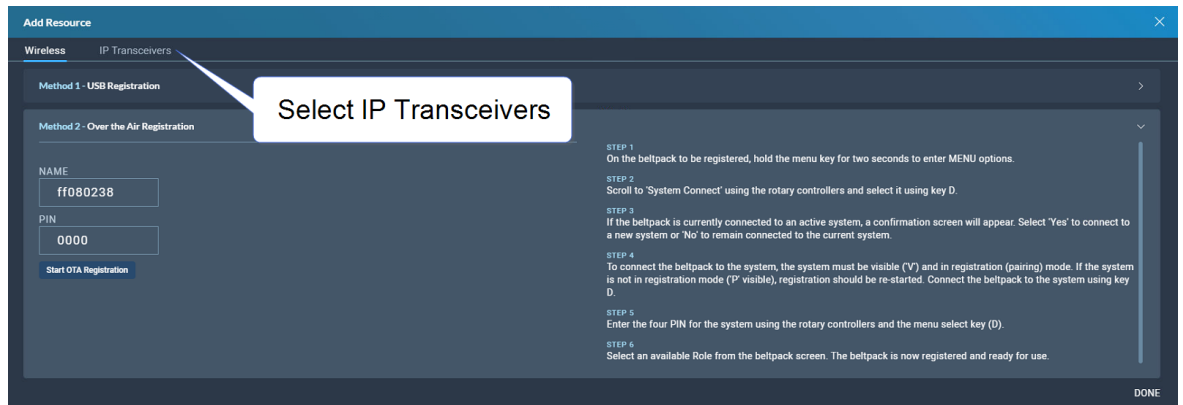

2. Select **IP Transceivers**. The following screen appears:

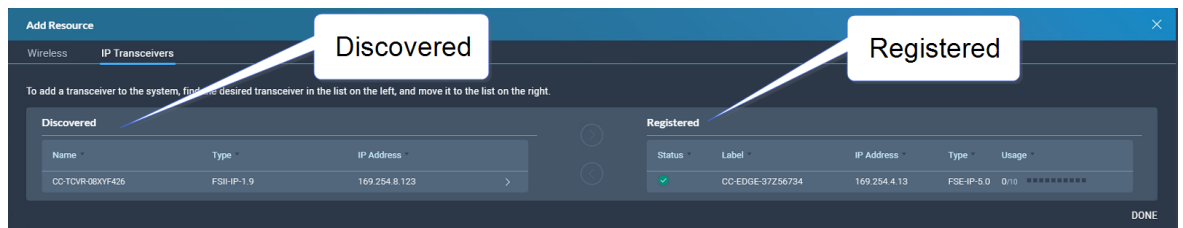

3. Select the transceiver that you want to register from the left-hand area of the screen, and click the right-hand arrow.

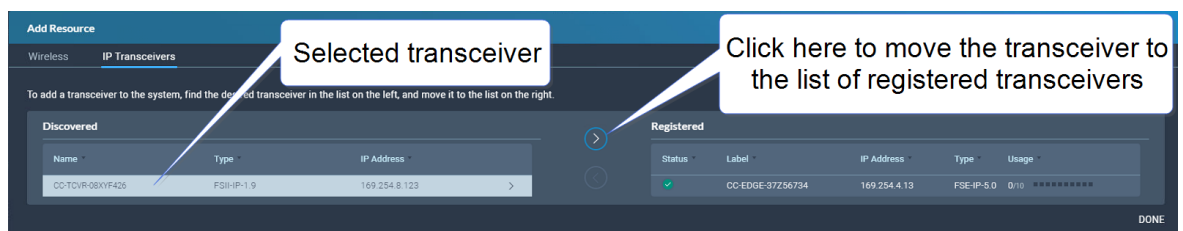

The selected transceiver appears in the right-hand list of registered transceivers.

6.4 Connecting Transceivers Over IP

When connecting IP transceivers, connect them to the LAN connector that is configured for AES67 on the rear of the Base Station using Ethernet cable.

See [Network Setup for IP Transceivers on page 57](#).

Once your transceivers are set up on the network you will add them to your system using the CCM.

See [Adding IP Transceivers on page 55](#).

6.5 Network Setup for IP Transceivers

The FreeSpeak Edge Base Station has LAN connections assignable to different network traffic such as Management, AES67, Dante and so on.

The LAN ports are fully user configurable but you can work with the following default settings:

- LAN 1: Management
- LAN 2: AES67 for FreeSpeak IP Transceivers
- LAN 3: Not configured (SFP)
- LAN 4: Not configured (SFP)

6.5.1 Connection to IP Transceivers, Example 1

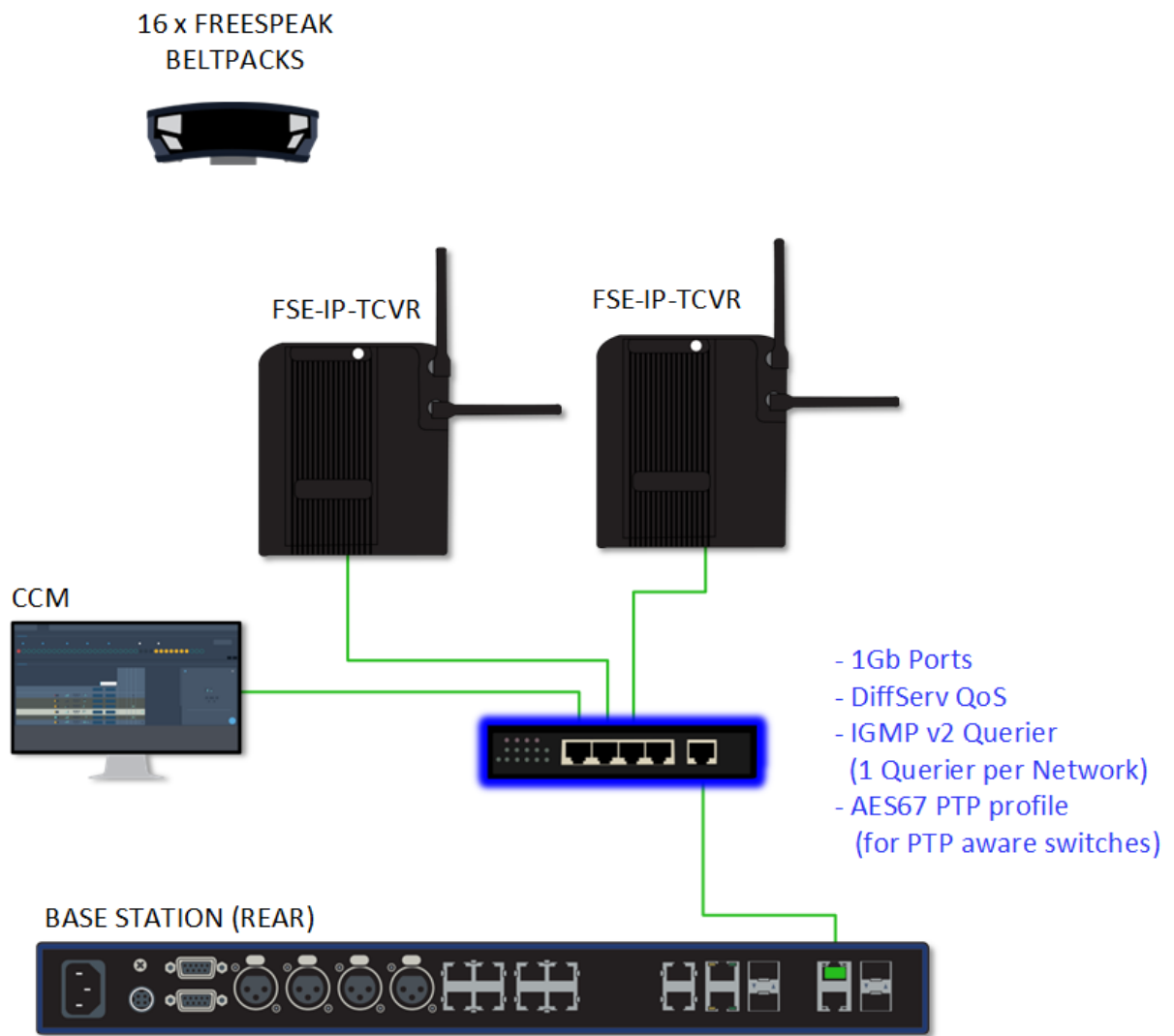

6.5.2 Connection to IP Transceivers and Dante, Example 2

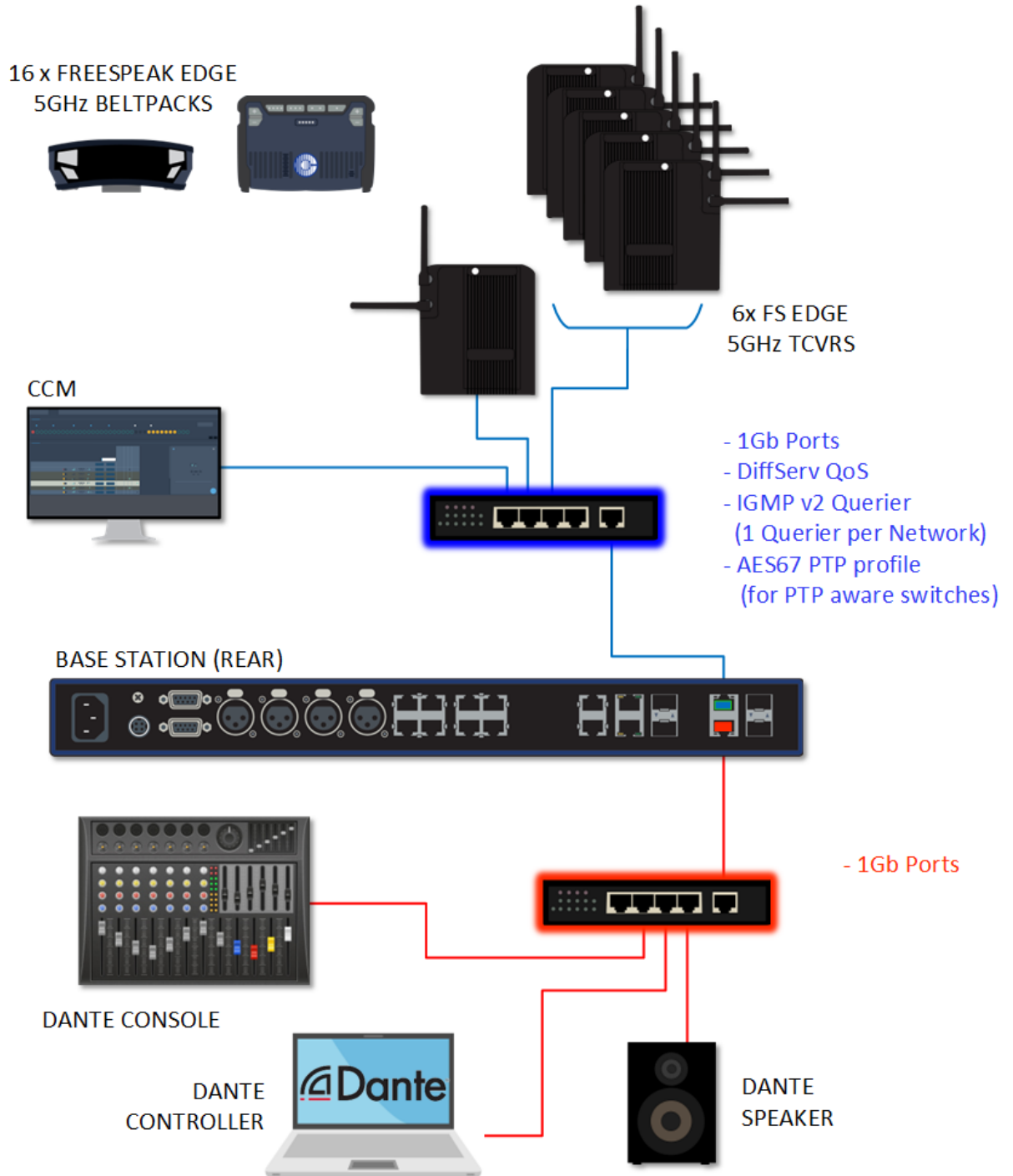

6.5.3 Connection to IP Transceivers and Dante, Example 3

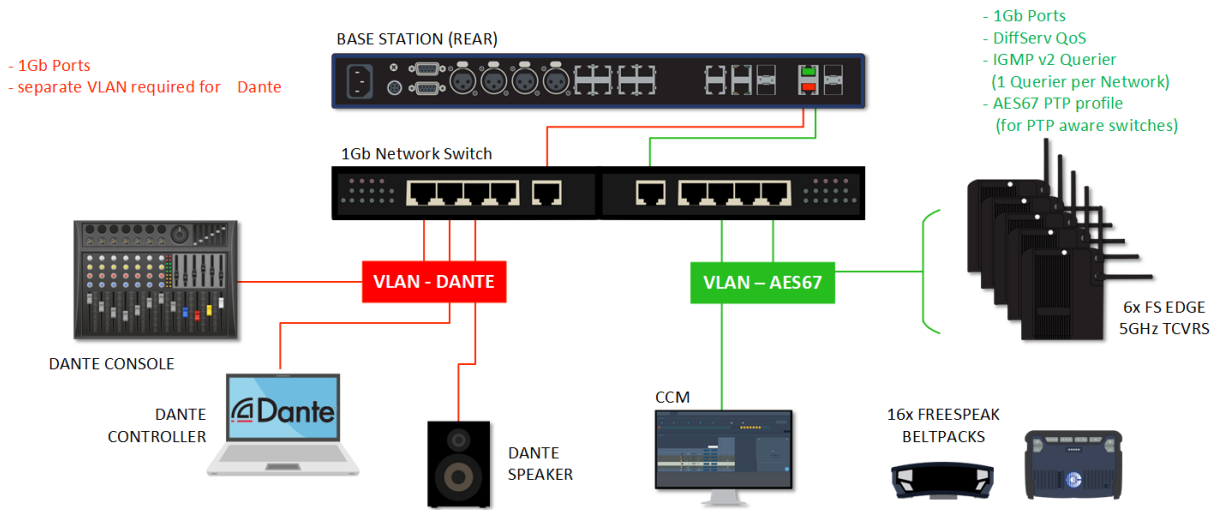

6.5.4 Connection to IP Transceivers, Example 4

If you are connecting to a network set up with heavy traffic, Clear-Com recommends that you split AES67 traffic into its own segment.

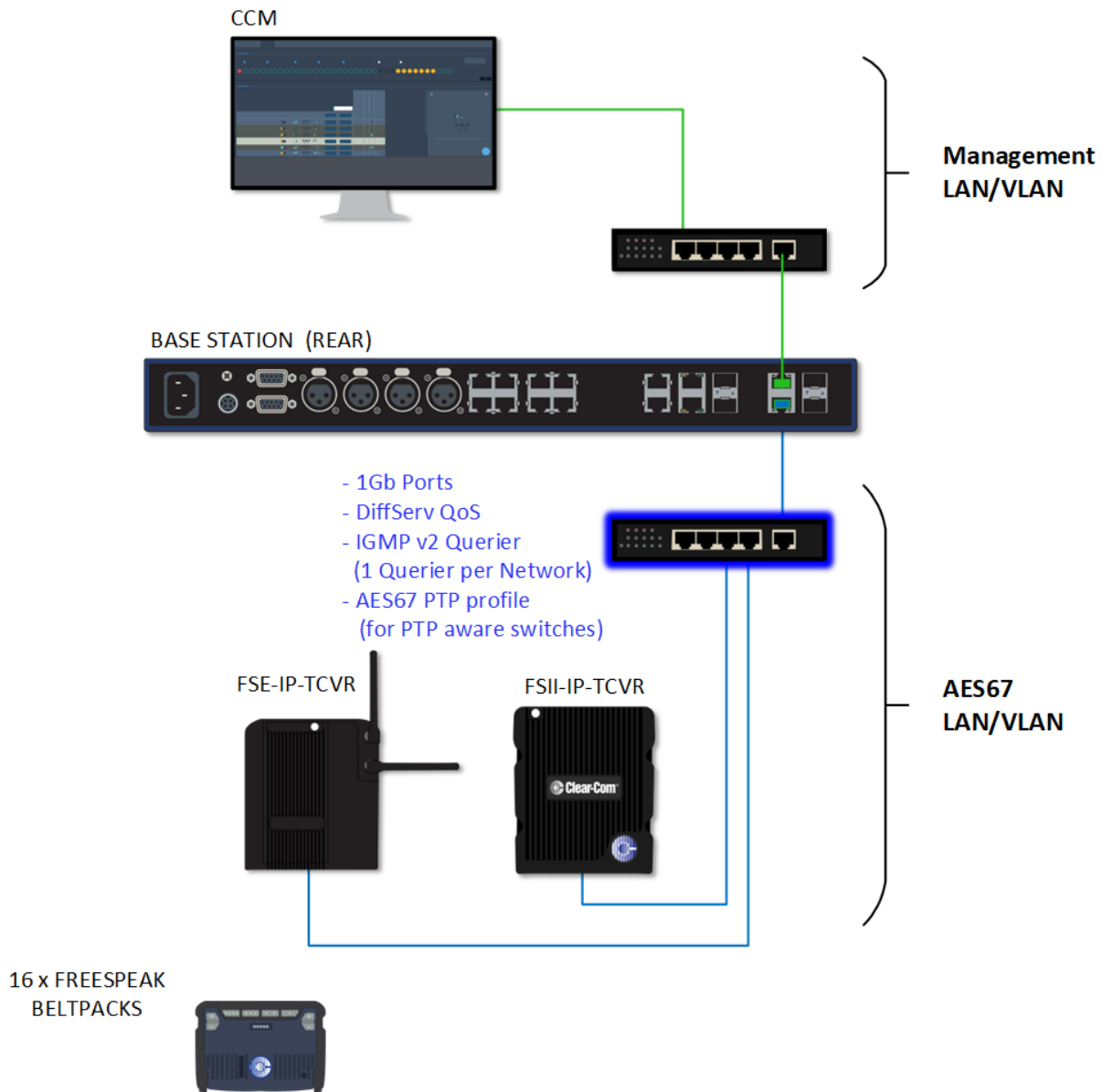

6.5.5 Setup Rules

- The default setup, Management on LAN 1 and AES67 on LAN 2, allows your computer to be connected directly to the FreeSpeak Edge Base Station for configuration and a dedicated switch to LAN 2 for FreeSpeak IP transceivers. This is in order to accommodate the IP transceivers' need for high clocking accuracy. Heavy traffic on your network will degrade the performance of your IP transceivers.
- For the AoIP network, try to keep the number of layer 2 hops between PTP leader and follower as low as possible (no more than 3). If more are required, consider using a Boundary Clock or a Transparent Clock.
- For more information on achieving a well-regulated PTP network and recommendations for suitable switches, see *Clear-Com AoIP Network Recommendations* available from the [FreeSpeak II Knowledge Center](#).
- Use DHCP (the default setting) for fast and easy setup of the devices. If the device does not encounter a DHCP server on the network it will automatically allocate an address in the link-local range (169.254.xx.xx).
- IP addresses can be configured statically under **Hardware > Resources > Network** in the CCM.
- For information on the 5 GHz transceiver (status and connection indicators) see the *Edge Transceiver Quick Start Guide* available from the [FreeSpeak Edge Knowledge Center](#).
- Connection status indicators on the FreeSpeak II IP transceiver are the same as the Edge transceiver (no channel scan).
- For PoE to the transceivers you will need a PoE capable network switch or PoE injector.

6.6 Registering FreeSpeak Beltpacks

Before you can use a beltpack, you must register it. This enables the FreeSpeak Edge Base Station to associate the beltpack with roles and assigned keys.

You can register a beltpack in two ways:

- By USB cable. When registering a beltpack in this way, a role that assigns keys to the beltpack is automatically created for the beltpack. The role can be edited as required in the **Configuration > Roles** page of the CCM.
- Over The Air (OTA). When you register a beltpack in this way you must create a role for it manually in **Configuration > Roles** before the beltpack can connect.

6.6.1 Registering a beltpack by USB cable

This method of registering beltpacks is recommended for fast and easy set up.

To register a beltpack using a USB cable, connect a beltpack to Base Station using a USB A to micro USB B (FSII) / USB C (FSE, FSIC) cable. The beltpack can be powered on either before or after connection. The Base Station will show 'Beltpack [ID] is now registered' in the front menu screens.

Note: *When beltpacks are registered in this way, a role with two channels (1 and 2) is automatically generated and applied to the beltpack. Roles can be edited at any time in the **Configuration** page of the CCM.*

6.6.2 Registering a beltpack OTA

To register a beltpack using OTA:

1. Navigate to **Hardware > Resources** and click **Add Resource**. The following screen appears:

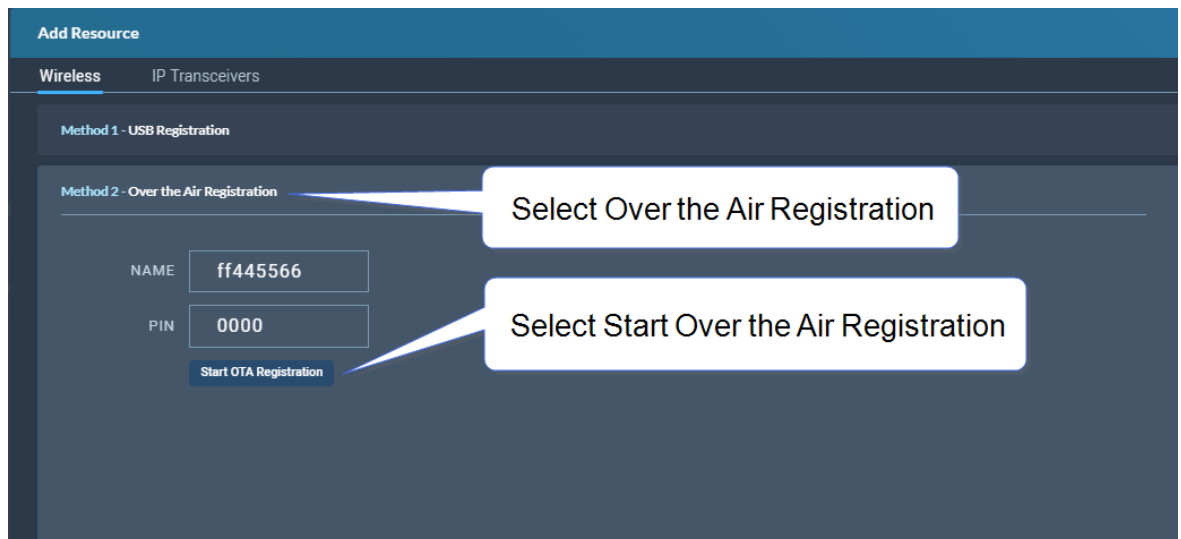

2. Click **Start OTA Registration**.

Note: *A timer is started indicating how long the system is open for registration. You can close OTA registration on the system at any point.*

6.6.3 Unregistering a beltpack

To unregister a beltpack, navigate to **Hardware > Resources > Endpoints** (click the down arrow to see all connected Endpoints (beltpacks)). Select an Endpoint by clicking on it. Select **Unregister**.

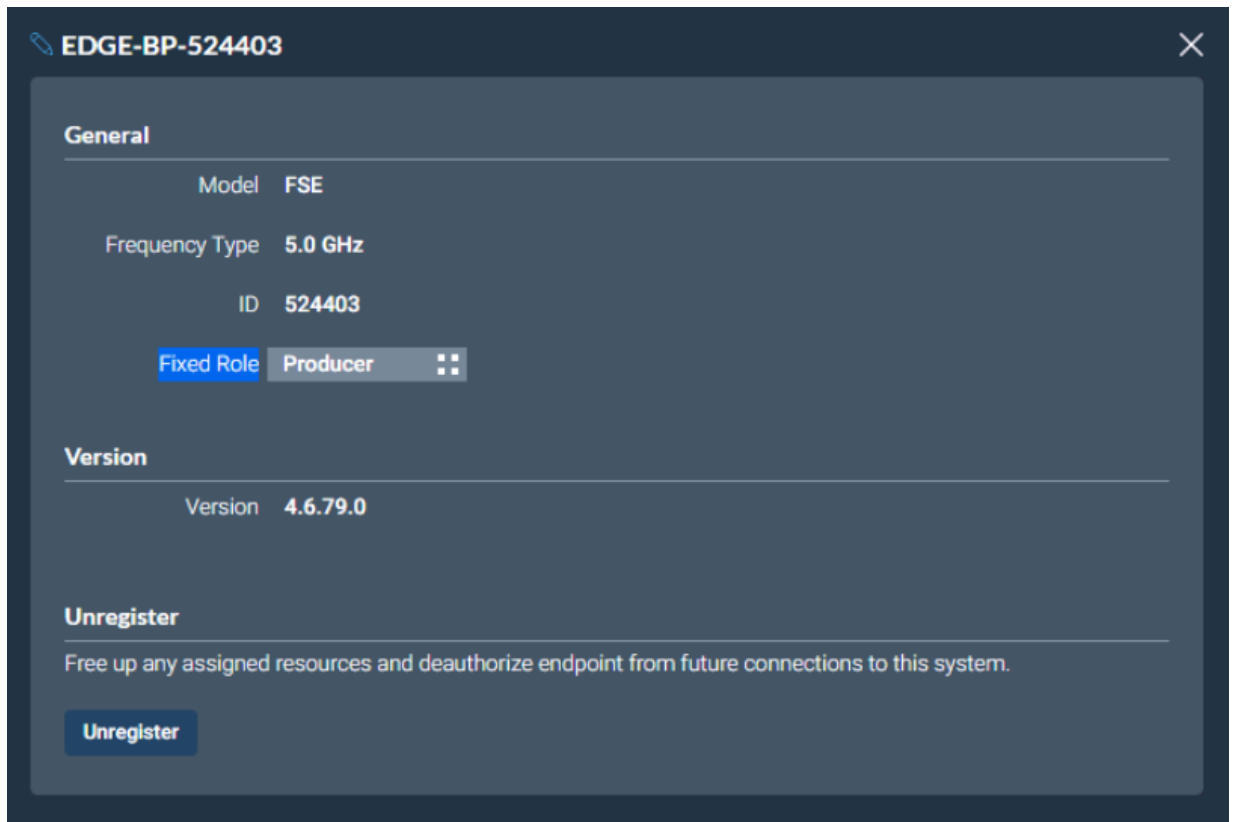

6.7 FS Edge Transceivers

Wireless region and channel setup are important when using FS Edge transceivers.

6.7.1 Wireless Region

Your Edge transceiver has a wireless region pre-configured, in order to comply with regional regulations. The wireless region setting in the CCM MUST match that of your transceiver, or the system will not work. You will see an error message in the **Status** page if the regions do not match.

To set the wireless region in the CCM, navigate to: **Hardware > Host > Wireless > Wireless Region**.

The screenshot displays the Clear-Com CCM interface for configuring a host device. The top navigation bar includes 'HARDWARE', 'CONFIGURATION', and 'STATUS' (with a warning icon). The 'Host' section is active, showing details for device 'ff080925'. The 'Wireless' tab is selected, showing the following configuration:

- General:** Administration PIN: 1111; System ID: 925; BP Role List Sorting: Role Number.
- Freespeak Edge:** Edge Wireless Region: US (highlighted by a callout box labeled 'Edge wireless region'); Excluded Channel(s): Unassigned; Scan All EDGE Transceivers button.
- Freespeak II:** Splitter/Transceiver 1: RJ45; Splitter/Transceiver 2: RJ45; Audio RF Filter: Enabled; AA Battery Type: Alkaline; Over The Air (OTA) PIN: 0000.

The left sidebar shows device details: NAME ff080925, TYPE Arcadia Central Station, IP ADDRESS 10.50.17.165, CONNECTIONS (2W, 4W, DANTE, FSE, FSII, HELIXNET, I.V. Direct), LICENSED PORTS 96, VERSION NUMBER 2.14.83.52, and POWER STATUS (AA Battery: red X, Power: green checkmark).

6.7.2 Channel Scanning

Note: Channel Scanning and auto channel selection are only available when at least one 5 GHz transceiver is registered to the system.

The FreeSpeak Edge transceiver system automatically selects channel 1, 2 and a backup channel (if using DFS channels) on each transceiver when you set it up. For best performance, you must ensure that selected channels are clear of interference from other devices. You can use the channel scanning feature and auto select the best channels for each transceiver. Channel scanning will scan all the 5 GHz channels in your local RF space.

To conduct a channel scan, navigate to: **Hardware > Resources > Transceivers [select transceiver] > Wireless Channels** and select **Refresh Scan**.

After channel scanning, to auto select the optimum channels for each transceiver use **Auto Select**.

The screenshot displays the 'Wireless Channels' configuration page for device CC-EDGE-26YYF731. It shows the current channel settings and a scan results chart. The chart plots 'Score' (0-100) for various channels, color-coded by availability: Low (red), Medium (yellow), and High (green). A table below the chart lists the channels with their respective scores, RSSI, Use, Ap, and SSID.

Refresh scan (Callout pointing to the Refresh Scan button)

Auto select best channels (Callout pointing to the Auto Select button)

Click on a channel to go to details for that channel in list view (Callout pointing to a channel in the list view)

You can see all available channels here. Scroll down to view (Callout pointing to the channel list table)

In this case you can see that the selected channels have low availability. It will be helpful to use auto select to find the optimum channels for this transceiver (Callout pointing to the low availability bars in the chart)

Channel	Score	RSSI	Use	Ap	SSID
36	22%	22%	0%	3	Cambridge_Guest, Cambridge_Users, Unknown System
40	28%	21%	0%	2	Cambridge_Guest, Cambridge_Users
44	22%	21%	13%	3	Edge System, Cambridge_Guest, Cambridge_Users
48	28%	21%	0%	2	Cambridge_Guest, Cambridge_Users
52	16%	28%	13%	3	Edge System, Cambridge_Guest, Cambridge_Users
56	36%	16%	4%	2	Cambridge_Guest, Cambridge_Users
60	15%	29%	14%	3	Edge System, Cambridge_Guest, Cambridge_Users

6.7.3 Channel Score

Channel **Score** is calculated using a weighted combination of:

- **RSSI** (Received Signal Strength Indicator)
- Channel activity (**Use**)
- Access points (**Ap**)

To scan all the transceivers in your network simultaneously, go to **Hardware > Host > Wireless > FS Edge > Scan All Edge Transceivers**.

For more detail on using FreeSpeak Edge transceivers, see the FreeSpeak Edge User Guide available online from the Clear-Com FreeSpeak Edge [Knowledge Center](#).

7 Using Dante Systems

To configure Dante you must be familiar with the Audinate Dante Controller, available from the Audinate website.

Before configuring the connection in the Dante Controller, you must determine which of the 4 LAN connectors on the Base Station you wish to use for Dante network traffic.

Note: *The PC running the Audinate Dante Controller must be connected to the Dante network.*

Note: *The Dante connection on the Station supports Dante and Dante AES67 audio interfacing.*

Determining which LAN connector you wish to use for Dante must be done in the CCM.

Navigate to **Hardware > Host**. Under the **Network** tab, select the port for Dante. This port will default to a DHCP setting. If you wish to configure a static IP address you must do this in the Dante controller.

The screenshot shows the Clear-Com CCM interface for configuring a Host Device. The top navigation bar includes 'HARDWARE', 'CONFIGURATION', and 'STATUS'. The 'Host' page is open, showing details for device 'ff080571'. The 'Network' tab is selected, displaying a list of LAN ports: LAN 1 (Management), LAN 2 (AES67), LAN 3 (Dante), and LAN 4. Below this list, the 'Traffic Type' section has radio buttons for Management, AES67, and Dante, with Dante selected. A 'Dante' configuration section is visible, showing 'Redundancy Mode' set to 'Secondary' and a warning message: 'Network configuration and Dante® cross-points need to be configured using the external Audinate® Dante® controller software. It has to be connected onto the primary DANTE® IP subnet to establish proper connection'. At the bottom, there are 'Cancel' and 'Apply' buttons. Two callout boxes are present: one pointing to the 'Dante' option under LAN 3 with the text 'Select Dante', and another pointing to the 'Apply' button with the text 'Apply'.

Note: *LAN 3 and 4 are for use with an SFP module (either fiber or RJ45).*

Note: *You must have sufficient licensed ports; each Dante channel consumes one licensed port.*

LAN connectors can be configured in any way you wish, but the CCM enforces that you can not configure IP transceivers (AES67) and Dante traffic on the same network. This is because AES67 network traffic has different timing requirements than Dante network traffic for FreeSpeak IP transceivers.

Dante IP configuration is configured in the Dante Controller.

1. In the CCM, navigate to **Hardware > Host > Network** and configure Dante on the LAN connector you wish to use for Dante connections.
2. Connect a cable (Cat5/6e or fiber) to the LAN connector that is designated for Dante. Connect the other end to a switch on your Dante network.
3. Open the Dante Controller and check that the network interface details are correct.

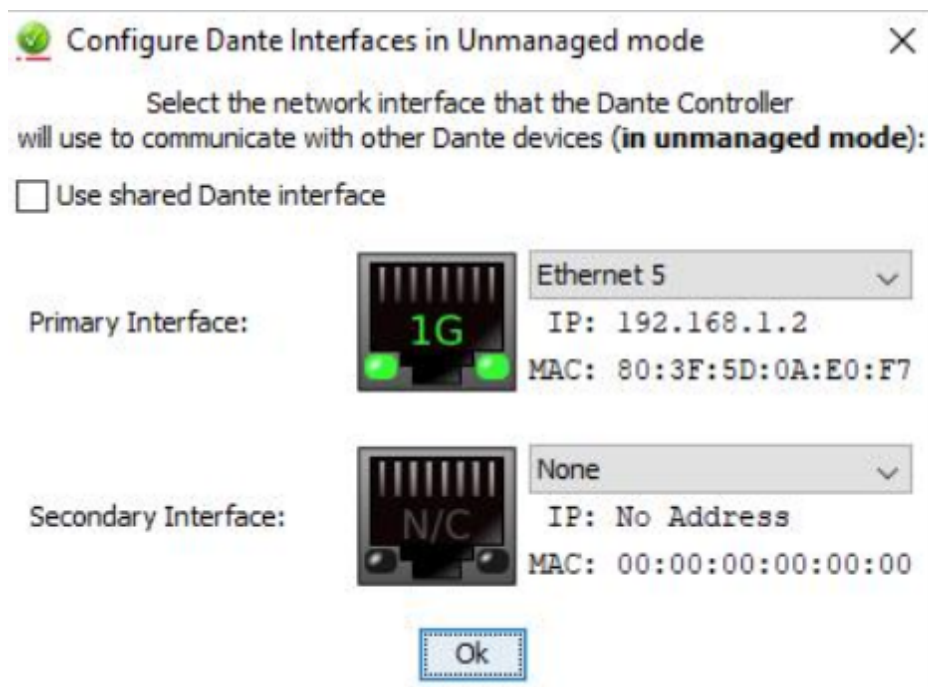

4. Check network and connection details under the **Status > Host Device** tab in the CCM.

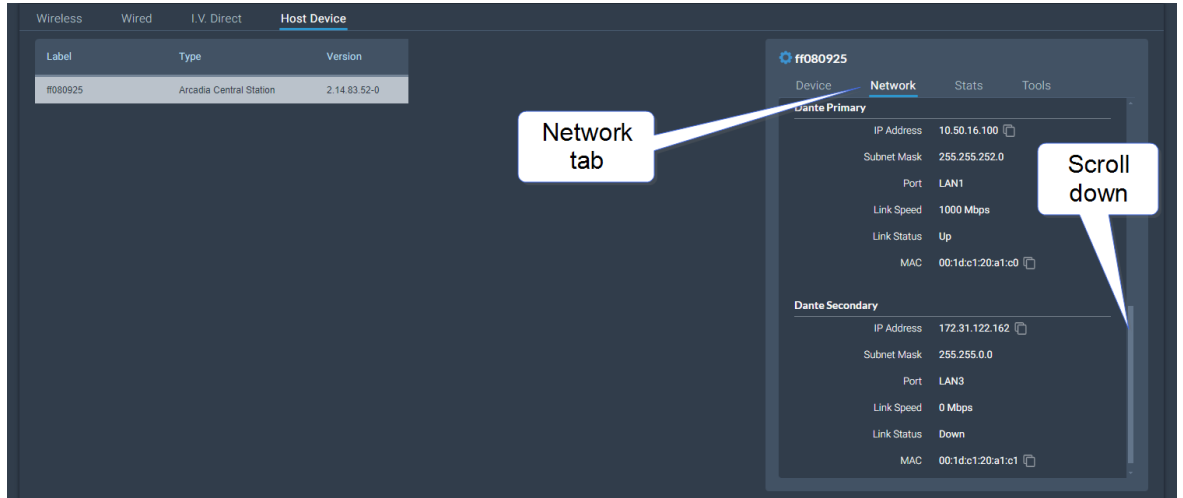

5. Details can also be viewed in the Dante Controller.

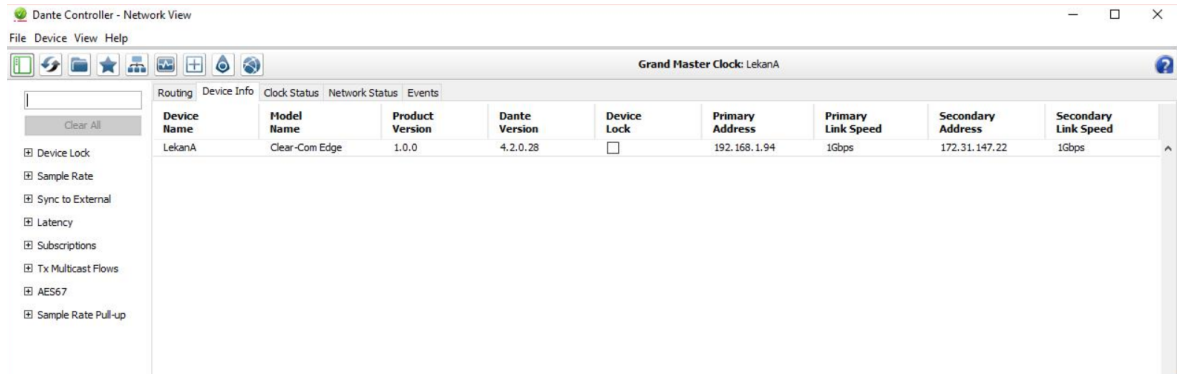

6. In the CCM navigate to **Hardware>Resources>Dante Ports** and add Dante ports. Give the new ports a suitable label.

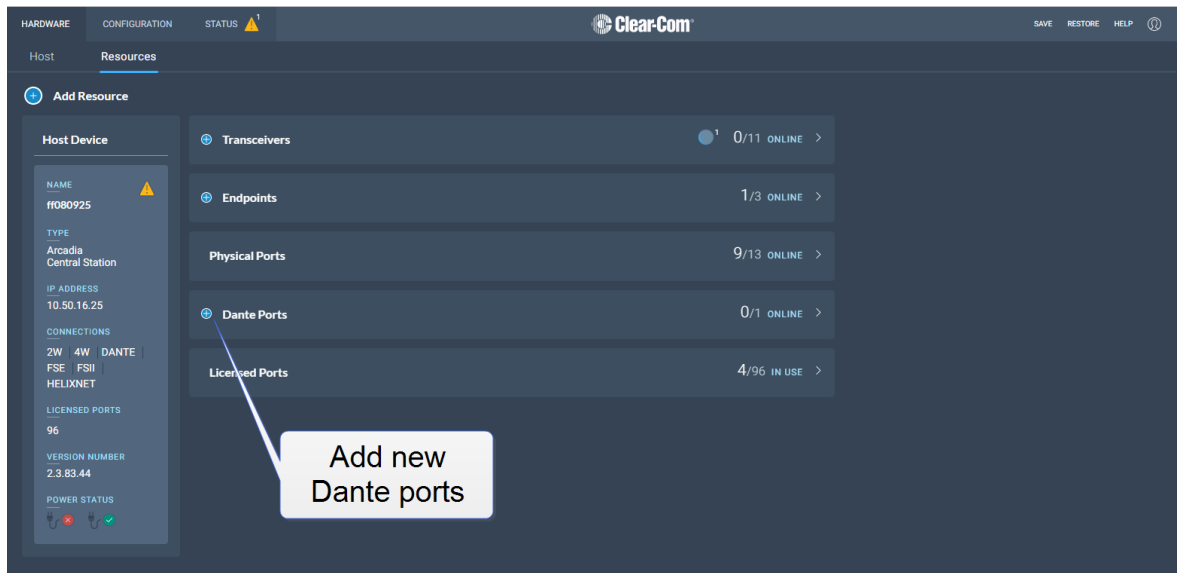

7. Route the channels as required in the Dante Controller.

- You will see available Dante ports in the **Configuration** page of the CCM. These ports can be assigned to channels on the Base Station in the usual way.
- Select the required channel click the **+** icon next to the port.

The screenshot displays the Clear-Com CCM Configuration page. The interface is divided into three main sections: Channels, Channel 1, and Ports.

Channels: A table showing the status of channels. The table has columns for Status, Id, Name, Online, and Talkers. Two channels are listed: Channel 1 (Id: 1, Name: Channel 1, Online: 2/2, Talkers: 1) and Channel 2 (Id: 2, Name: Channel 2, Online: 1/1, Talkers: 0).

Channel 1: A diagram showing the connection between Dante P 1 and Edge Base.

Ports: A list of available ports. The list is categorized into 2W, 4W, and Dante ports. A callout box with the text "Click here" points to the "+" icon next to Dante P 1 in the Dante section.

Status	Id	Name	Online	Talkers
✓	1	Channel 1	2/2	1
✓	2	Channel 2	1/1	0

Port	Port	Assigned
2W-Port A	2W-Port A	None
2W-Port B	2W-Port B	None
2W-Port C	2W-Port C	None
2W-Port D	2W-Port D	None
4W		
4W-Port1	4W-Port 1	None
4W-Port2	4W-Port 2	None
4W-Port3	4W-Port 3	None
4W-Port4	4W-Port 4	None
4W-Port5	4W-Port 5	None
4W-Port6	4W-Port 6	None
4W-Port7	4W-Port 7	None
4W-Port8	4W-Port 8	None
Dante		
Dante P 1	Dante-Port 1	Channel 1
Dante P 2	Dante-Port 2	None
Dante P 3	Dante-Port 3	None
Dante P 4	Dante-Port 4	None
Dante P 5	Dante-Port 5	None
Dante P 6	Dante-Port 6	None
Dante P 7	Dante-Port 7	None
Dante P 8	Dante-Port 8	None

8 Using 2-Wire Systems

This chapter describes how to use the FreeSpeak Edge Base Station with 2-Wire intercom devices. It contains the following sections:

8.1 Introduction to 2-Wire Systems	72
8.2 2-Wire Port Compatibility	75

8.1 Introduction to 2-Wire Systems



- Power: Enabled/**disabled**
- Mode: **Clear-Com**/RTS
- Termination: Enabled/**disabled**
- Nulling: Start Nulling

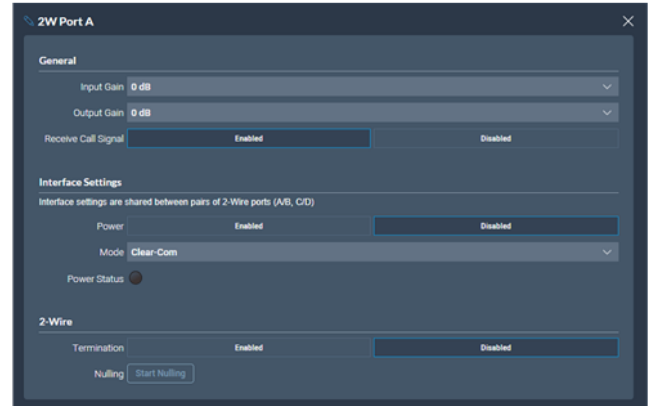

When connecting 2-wire equipment the following applies:

- **Terminate**
 - 2-wire partyline circuits must be terminated once on the line
 - Do not terminate on more than one device in the system
 - Enable/disable the termination. Default setting: **Disabled**
 - The Station default setting assumes the 2-wire partyline is nulled elsewhere in the system (i.e. at a partyline main station or power supply)

Line termination is set in the CCM only. To do this, in the CCM navigate to: **Hardware > Resources > Physical Ports**. See below

- **Power**
 - 2-wire partyline beltpacks can be powered by the Station 2-wire ports. Quantity of beltpacks and length of cable are variables, dependent on the type of devices and existing cabling
 - To calculate what will work best in your circumstances, see the *Encore Partyline Power Calculator*, available from the [Encore Knowledge Center](#)

- Enable/disable the partyline power. Default setting: **Disabled**
- The Station default setting assumes the 2-wire partyline is powered elsewhere in the system (i.e. using a partyline main station or power supply)

Note: *Enabled power indication in the CCM is green. Enabled power indication on the Station backpane is red.*

- These functions can be set either in the 2-wire port settings page of the CCM or from the front panel menu on the Station
- **Null**
 - 2-wire null serves the purpose of isolating audio that goes to the 2-wire partyline from the Station from the audio that comes from the 2-wire partyline to eliminate undesirable echo. The null is trained to the properties of the partyline cabling and equipment connected to the Station and varies depending on the setup
 - Keep the following in mind for nulling:
 - Microphones on the 2-wire partylines should be unlatched
 - RMK before initiating the Null process
 - Ensure the 2-wire partyline is not in use
 - Null again if equipment or cabling is changed on the 2-wire partyline
- **Assign**
 - 2-wire port may need to be assigned to channels or role keys as appropriate

To configure 2-wire port settings in the CCM navigate to: **Hardware > Resources > Physical Ports > (select port)** :

2W Port A

General

Input Gain **0 dB**

Output Gain **0 dB**

Receive Call Signal **Enabled** Disabled

Interface Settings

Interface settings are shared between pairs of 2-Wire ports (A/B, C/D)

Power **Enabled** Disabled

Mode **Clear-Com**

Power Status

2-Wire

Termination **Enabled** Disabled

Nulling **Start Nulling**

8.2 2-Wire Port Compatibility

When connecting Clear-Com Stations to other Clear-Com equipment and third-party systems (2-wire) use the following guidelines.

Device Type	Supports call signaling?
HelixNet HLI-2W2*	Yes
Encore MS-702/4	Yes
Encore RS Beltpack RS-701 / 702 / 703	Yes
RTS 2-wire equipment	Yes, but does not pass call signaling to 4-wire audio routes.
FreeSpeak/FreeSpeak II Base II*	Yes
2-way radio	Yes, via a TW-47 interface

*Where there is a choice between a 2-wire and a 4-wire connection, 4-wire provides the best audio quality and is preferred.

9 Using 4-Wire Systems

This chapter describes how to use the FreeSpeak Edge Base Station with 4-Wire intercom devices. It contains the following sections:

9.1 Connecting 4-Wire	77
9.2 Port Function (4-Wire Pinout)	81
9.3 Connecting 4-Wire Clear-Com to Clear-Com	82
9.4 Setting Port Function (Pinout) on a 4-Wire Connection	83

9.1 Connecting 4-Wire

When referring to intercoms, a four-wire circuit describes an intercom connection (I/O) where there are four wires (two paths) and the paths are different for talk and listen.

Analog or four-wire circuits use two pairs for balanced line-level audio signals, one for input and the other for output, using four wires in total.

Note: *A four-wire audio circuit is further defined by the attribute that the two paths can be used for unassociated signals. This means that the source input is not always associated with or routed to the destination output. This is commonly known as a four-wire split or split port. At the time of writing, a split port is only available on Eclipse-HX Digital Matrix products.*

Note: *To minimize noise and meet regulatory requirements, use screened (shielded) cable when connecting 4-wire ports.*

9.1.1 Connecting Audio - Non-Clear-Com to Clear-Com (4-Wire)

All Clear-Com four-wire audio ports are analog format line level (0 dBu nominal / 18 dBu max).

When connecting non-Clear-Com equipment to a Clear-Com device, the following is the correct default pinout of the four-wire port (RJ45) for input and output.

Note: *Except the Eclipse MVX-A16 interface card (input 3 & 6, output 4 & 5).*

Pin	Use	
1	n/a	<p>RJ45 Pinout T-568B</p> <p>1. White Orange 5. White Blue 2. Orange 6. Green 3. White Green 7. White Brown 4. Blue 8. Brown</p>
2	n/a	
3	Audio Out +	
4	Audio In +	
5	Audio In -	
6	Audio Out -	
7	n/a	
8	n/a	

Note: Always read your 3rd party device manual before connecting to Clear-Com.

Note: The above diagram illustrates the default pinout mode for Clear-Com RJ45 : 4-wire-X. See **Port Function** for details.

XLR Breakout Cable Termination to RJ45 4-Wire

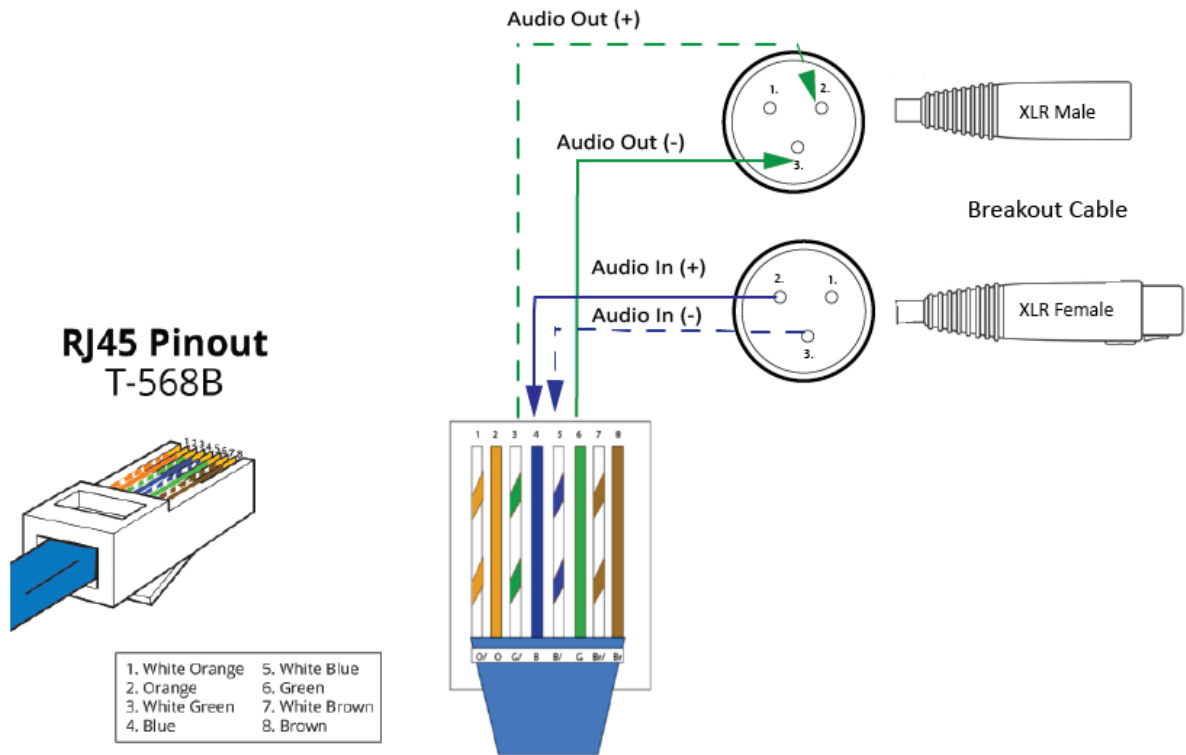

A breakout cable is supplied with the Arcadia and Edge stations. For other connections you need to make your own cable.

CAB-RJ45-PGM-SA - Four-Wire Analog Audio Splitter Cable - PGM/SA with RJ45 to 3-pin XLR-F & 3-pin XLR-M.

XLR Panel Termination to RJ45 4-Wire

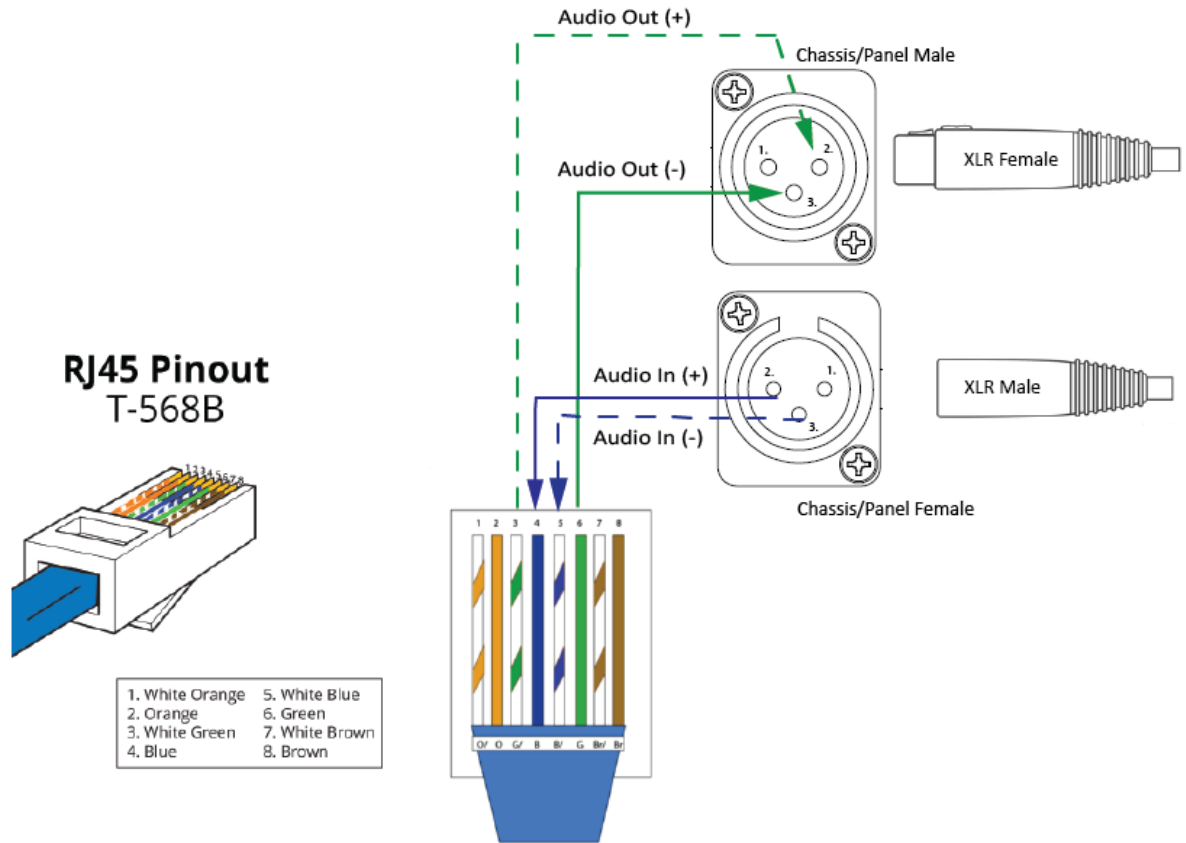

9.2 Port Function (4-Wire Pinout)

Some 4-wire RJ45 connectors on Clear-Com products include a software configuration that switches audio I/O pin configuration according to the device you are connecting to. This means that when connecting to Clear-Com devices, a cross-over cable is not necessary.

Clear-Com devices can have the following RJ45 4-wire pinouts:

- Clear-Com **4-Wire (To Panel)** on older systems)
- Clear-Com **4-Wire -X(To Matrix)** on older systems)
- Configurable, (either pinout is possible, according to the **Port Function** toggle switch).

To set the **Port Function** toggle, go to **Port Options** in the CCM or the device front panel menu system.

9.2.1 RJ45 Pinouts (Port Function Toggle)

Pin No	4-wire (To Panel)	4-wire-X (default) (To Matrix)
1	Data in +	Data out +
2	Data in -	Data out -
3	Audio in +	Audio out +
4	Audio out +	Audio in +
5	Audio out -	Audio in -
6	Audio in -	Audio out -
7	Data out +	Data in +
8	Data out -	Data in -

9.2.2 Clear-Com RJ45 4-Wire Pinout type by Device

Device	Clear-Com RJ45 pinout type on this device (Port Function)
FreeSpeak II	4-wire-X (fixed)
HelixNet HLI-4W2	4-wire-X (fixed)
HME DX200/DX210/DX410	4-wire-X (fixed)
Eclipse MVX-A16	4-wire (fixed)
FreeSpeak II Base II	Configurable. Default setting is 4-wire-X
FreeSpeak Edge Base	Configurable. Default setting is 4-wire-X .
LQ Series	Configurable. Default setting is 4-wire-X

9.3 Connecting 4-Wire Clear-Com to Clear-Com

When connecting Clear-Com to Clear-Com, one device must be in **4-wire** mode and one device must be in **4-wire-X** mode if you wish to use a straight-through cable.

9.3.1 Example: 4-Wire RJ45 port 8 on Edge and Arcadia Stations - PGM and SA

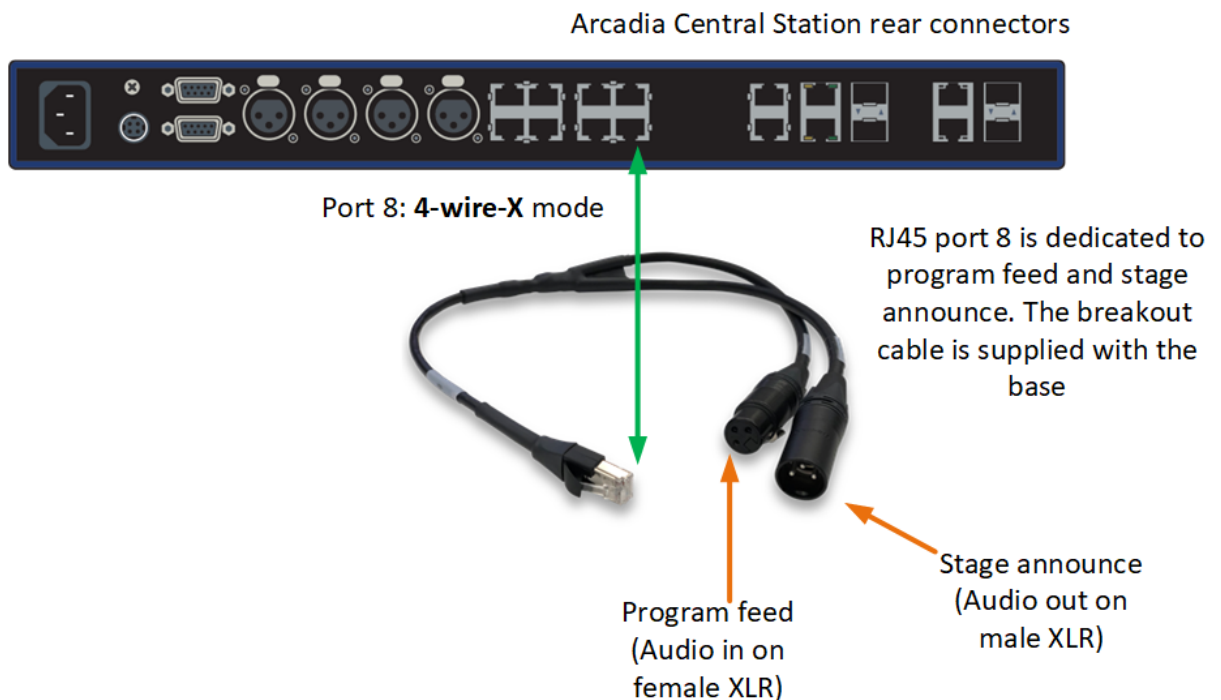

9.4 Setting Port Function (Pinout) on a 4-Wire Connection

1. Connect the devices using 1:1 Cat5/6/6e cable.
2. In the CCM, navigate to **Hardware > Resources > Physical Ports**.
3. Select the 4-wire port.
4. Select **Port Function**.

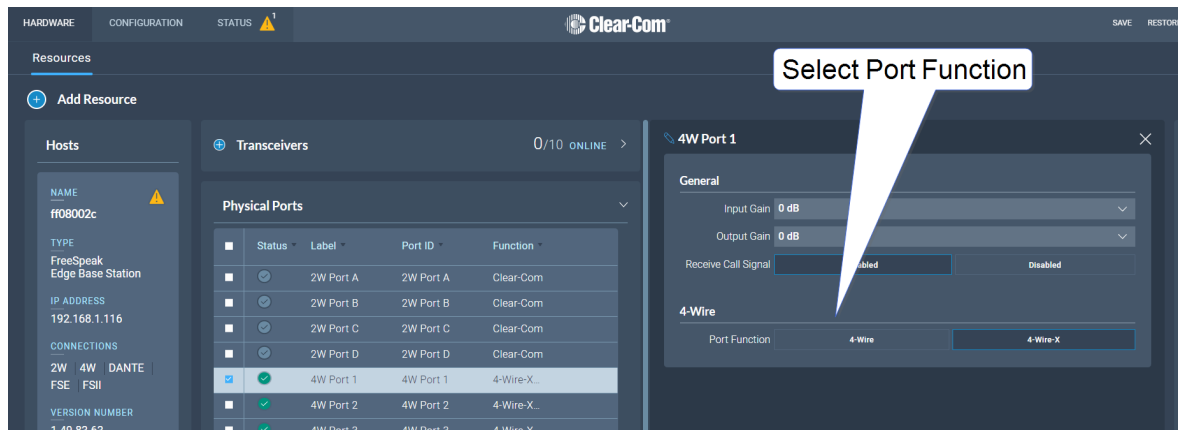

10 Network Setup

This chapter describes how to set up and configure your network for FreeSpeak Edge Base Station IP transceivers. It contains the following sections:

10.1 Network Setup for IP Transceivers	85
10.2 LAN Configuration Rules	89
10.3 AES67 Network - PTP Follower Configuration	91

10.1 Network Setup for IP Transceivers

The FreeSpeak Edge Base Station has LAN connections assignable to different network traffic such as Management, AES67, Dante and so on.

The LAN ports are fully user configurable but you can work with the following default settings:

- LAN 1: Management
- LAN 2
- LAN 3: Not configured (SFP)
- LAN 4: Not configured (SFP)

10.1.1 Connection to IP Transceivers, Example 1

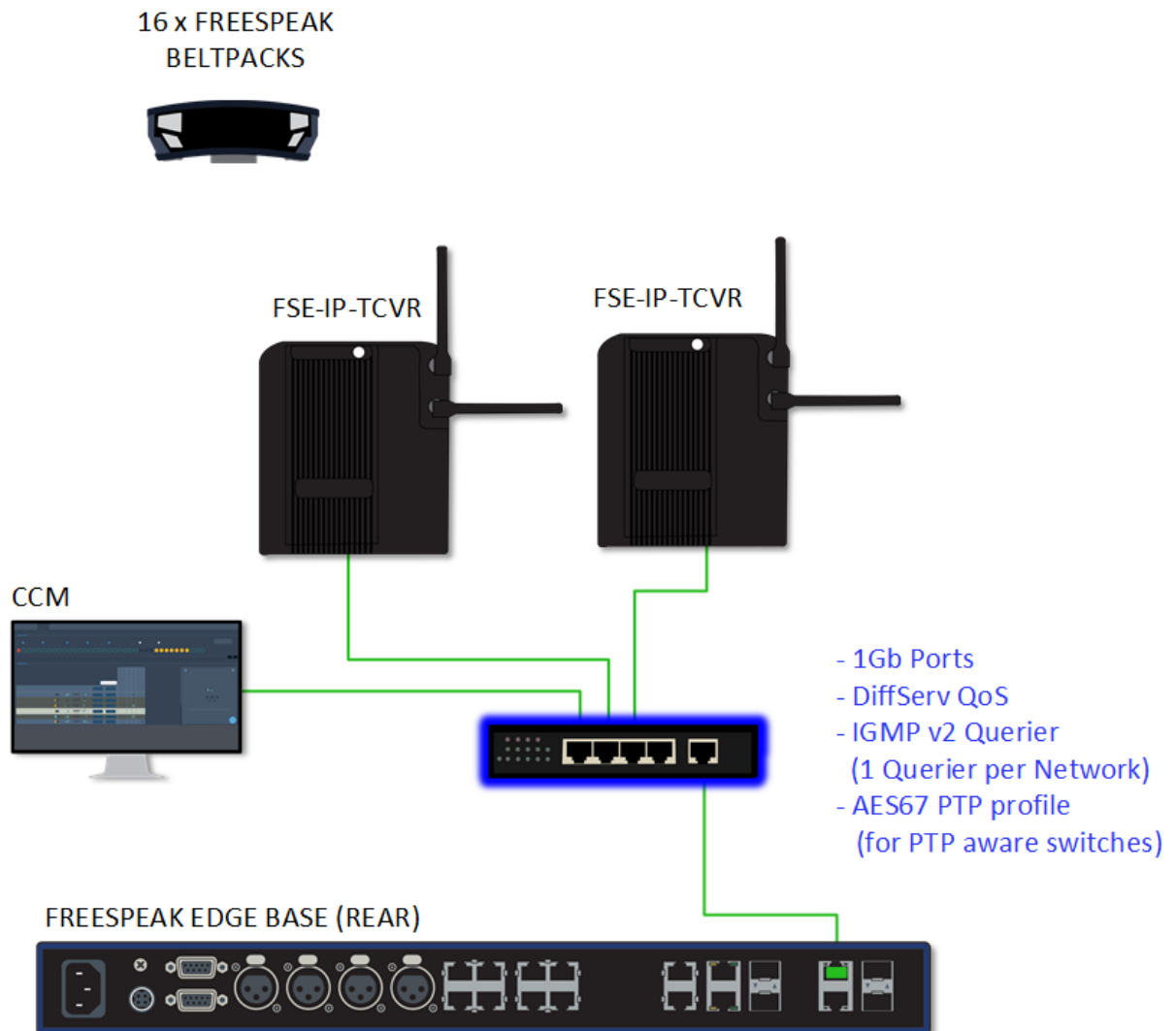

10.1.2 Connection to IP Transceivers and Dante, Example 2

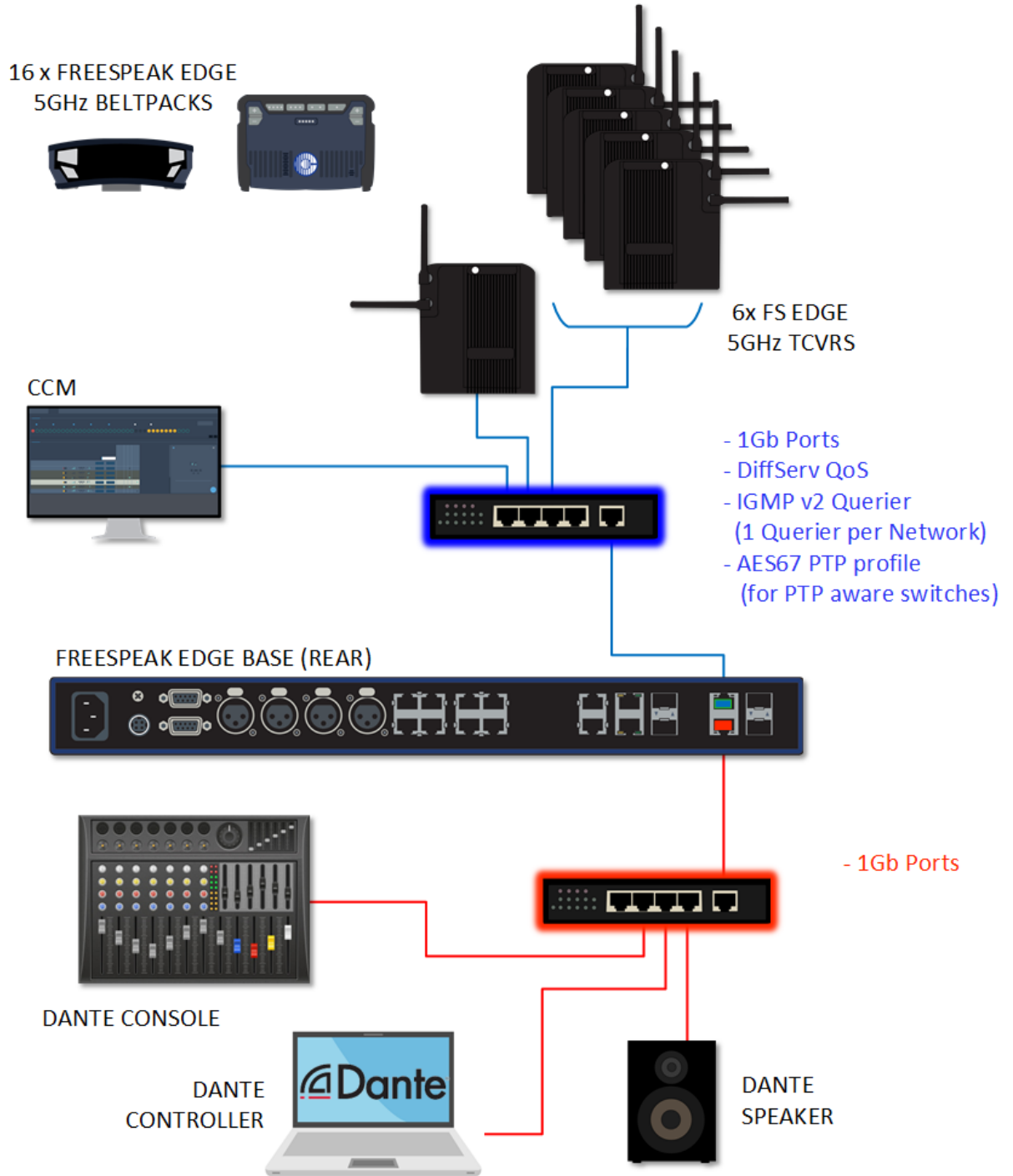

10.1.3 Connection to IP Transceivers and Dante, Example 3

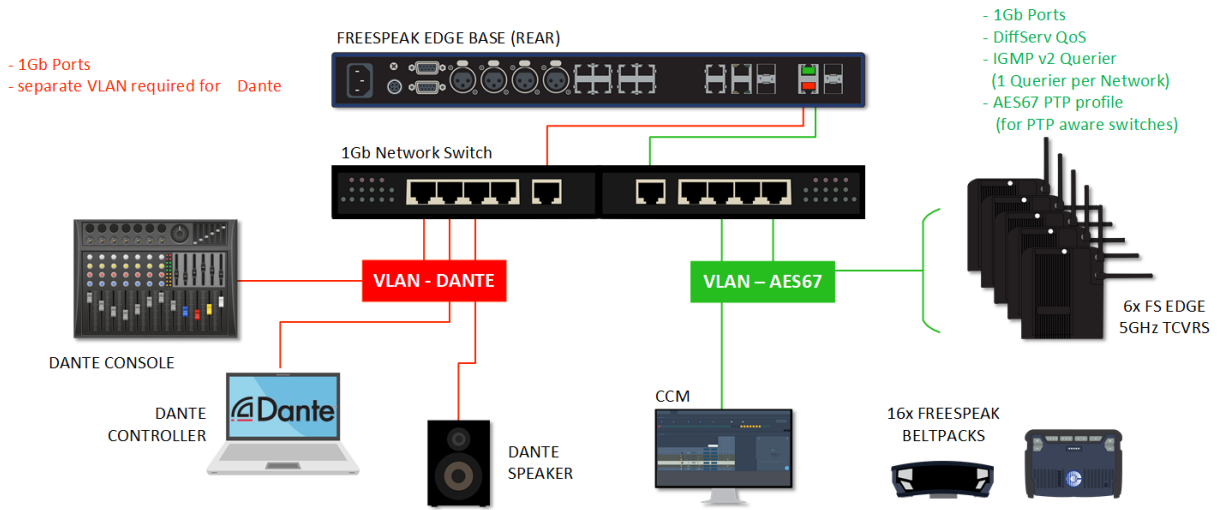

10.1.4 Connection to IP Transceivers, Example 4

If you are connecting to a network set up where there is lots of traffic, either management or AES67, Clear-Com recommends that you split AES67 traffic into its own segment.

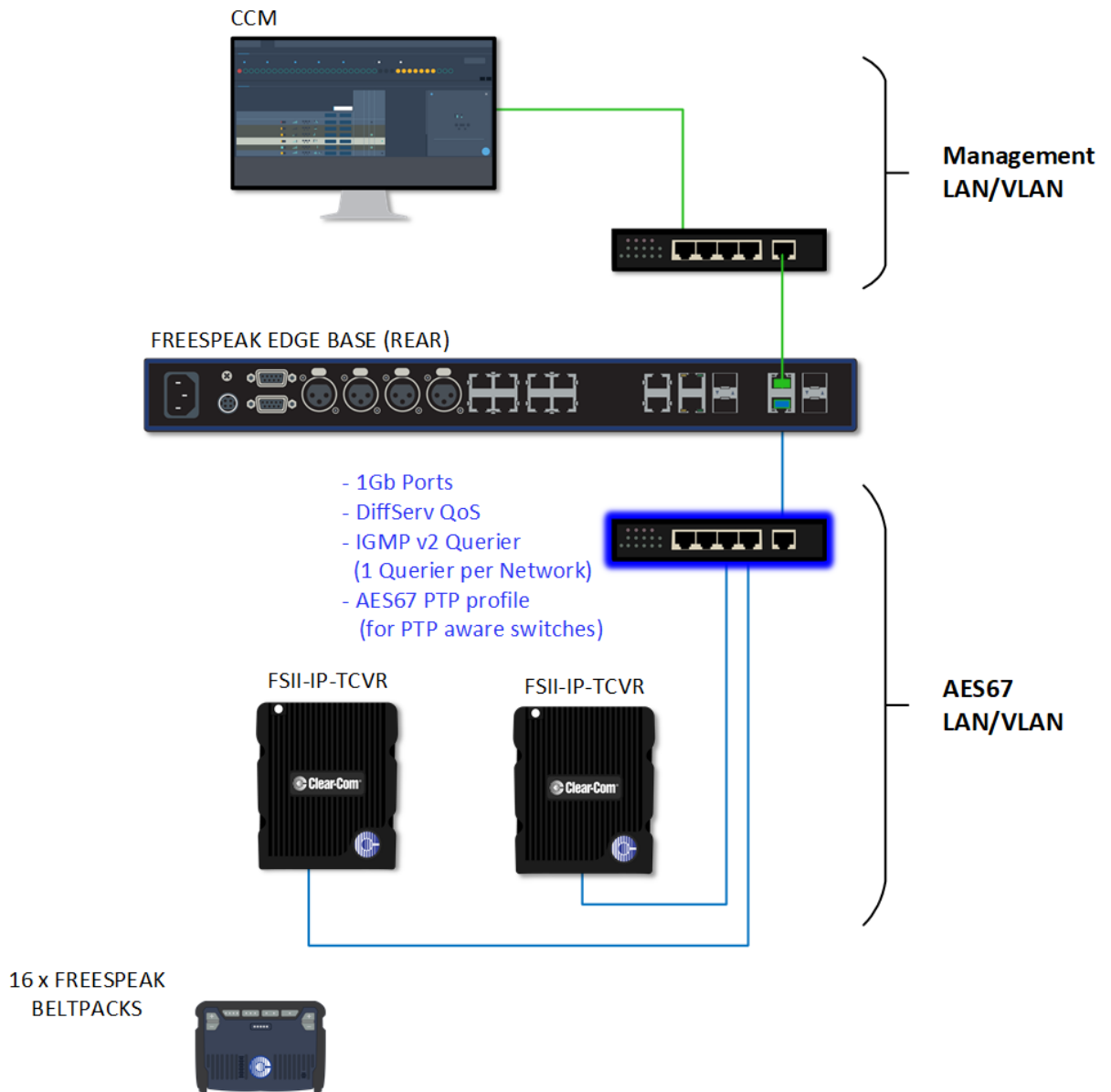

10.1.5 Setup Rules

- The default setup, Management on LAN 1 and AES67 on LAN 2, allows your computer to be connected directly to the Base Station for configuration and a dedicated switch to LAN 2 for FreeSpeak IP transceivers. This is in order to accommodate the IP transceivers' need for high clocking accuracy. Too much traffic on your network will degrade the performance of your IP transceivers.
- For the AoIP network, try to keep the number of layer 2 hops between PTP leader and follower as low as possible (no more than 3). If more are required, consider using a Boundary Clock or a Transparent Clock.
- For more information on achieving a well-regulated PTP network and recommendations for suitable switches, see *Clear-Com AoIP Network Recommendations* available from the [FreeSpeak II Knowledge Center](#).
- Use DHCP (the default setting) for fast and easy setup of the devices. If the device does not encounter a DHCP server on the network it will automatically allocate an address in the link-local range (169.254.xx.xx).
- IP addresses can be configured statically under **Hardware > Resources > Network** in the CCM.
- For information on the 5 GHz transceiver (status and connection indicators) see the *Edge Transceiver Quick Start Guide* available from the [FreeSpeak Edge Knowledge Center](#).
- Connection status indicators on the FreeSpeak II IP transceiver are the same as the Edge transceiver (no channel scan).
- For PoE to the transceivers you will need a PoE enabled network switch.

10.2 LAN Configuration Rules

Note: *Do not plug any two LAN ports into the same LAN or VLAN. This can create a network loop affecting IP stability.*

Note: *Configuring/changing the AES67 IP address will cause the Base Station to reboot.*

10.2.1 AES67 Rules

- AES67 should not be on the same subnet as Management unless on the same LAN port
- AES67 cannot be on the same LAN port as DANTE primary or secondary

Note: *Clear-Com recommends that you configure AES67 port on the Station to a Static IP address if there is no third-party DHCP server on the network.*

10.2.2 IP Rules

- The IP addresses cannot be in the reserved range: 10.0.0.0-10.0.0.7
 - The subnet mask may cause an overlap with the reserved range
- The IP addresses cannot be in the LQ tunnel range 172.23.xxx.xxx
- The IP addresses cannot be in the localhost range 127.xxx.xxx.xxx
- The IP addresses cannot be in the multicast range 224.xxx.xxx.xxx-239.xxx.xxx.xxx

10.2.3 Static IP Rules

- The static IP addresses cannot be in link local range: 169.254.xxx.xxx

Note: *Clear-Com recommends that you configure AES67 port on the Station to a Static IP address if there is no third-party DHCP server on the network.*

10.2.4 Dante Rules

- Dante primary and secondary cannot be on the same LAN port (rear connector)

10.2.5 Management Rules

- You cannot disable the Management LAN.

10.3 AES67 Network - PTP Follower Configuration

PTP Follower Mode

- **Enabled:** The intercom station is set as PTP Follower
- **Disabled** (default setting): The intercom station is set as PTP Reference, unless there is a PTP Reference on the network with a priority higher than 127

10.3.1 Setting the PTP clocking status of your intercom stations

1. In the CCM, navigate to : **Hardware > Host > Network**[select the LAN that has been configured for AES67] > **PTP Follower Mode**
2. Select **Enabled**
3. Click **Apply**

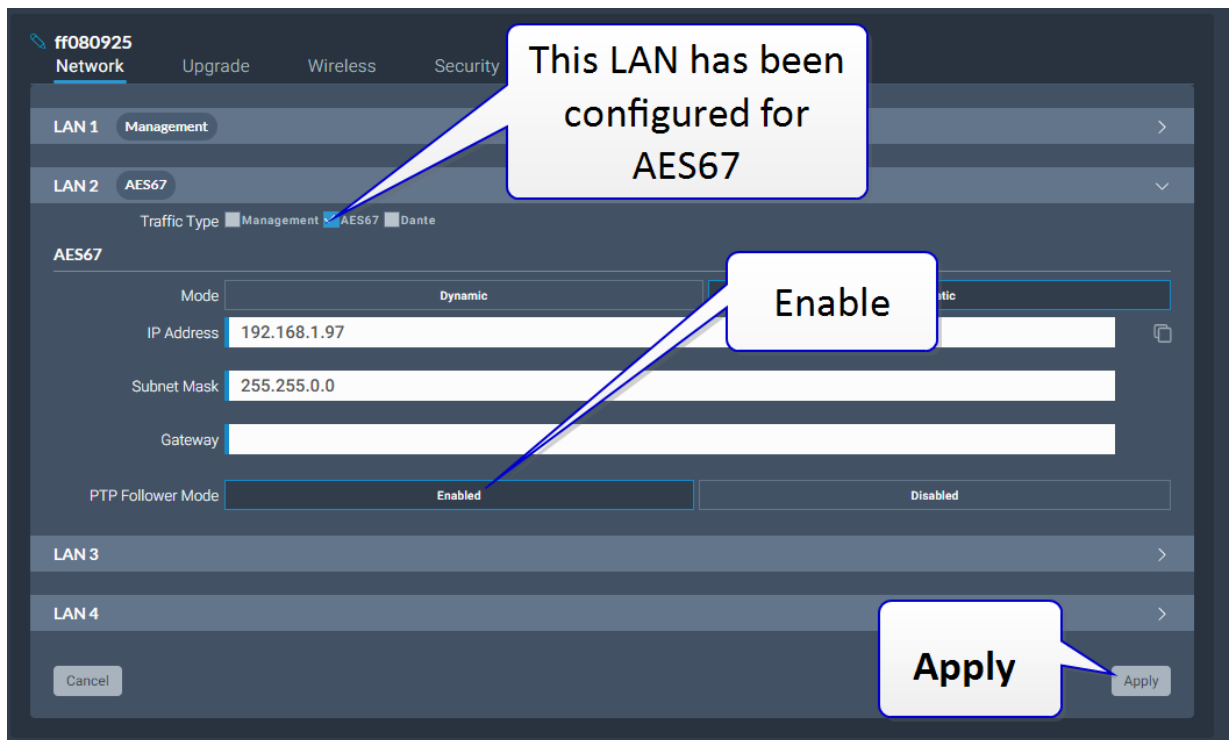

The system will warn you that there must be a Reference clock on your network. While the clock is synchronizing (or if there is no PTP Reference clock on your network) you will see **Status FREERUN** in the device **Stats** tab. When the clocks are synchronized, you will see **Status LOCKED**.

In the CCM navigate to : **Status > Overview > Host Device > Stats:**

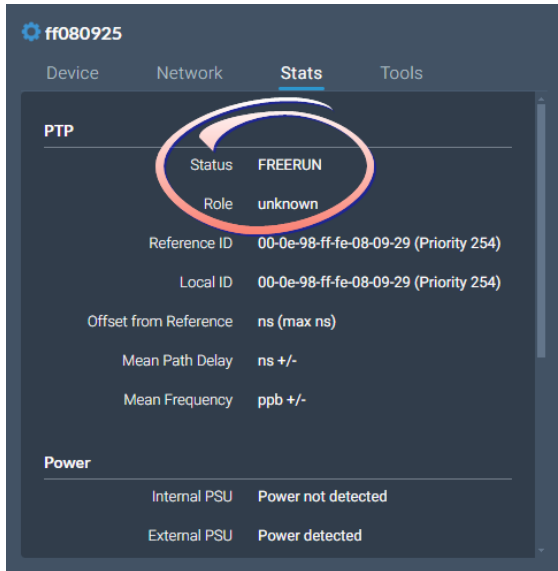

ff080925

Device Network **Stats** Tools

PTP

Status	FREERUN
Role	unknown
Reference ID	00-0e-98-ff-fe-08-09-29 (Priority 254)
Local ID	00-0e-98-ff-fe-08-09-29 (Priority 254)
Offset from Reference	ns (max ns)
Mean Path Delay	ns +/-
Mean Frequency	ppb +/-

Power

Internal PSU	Power not detected
External PSU	Power detected

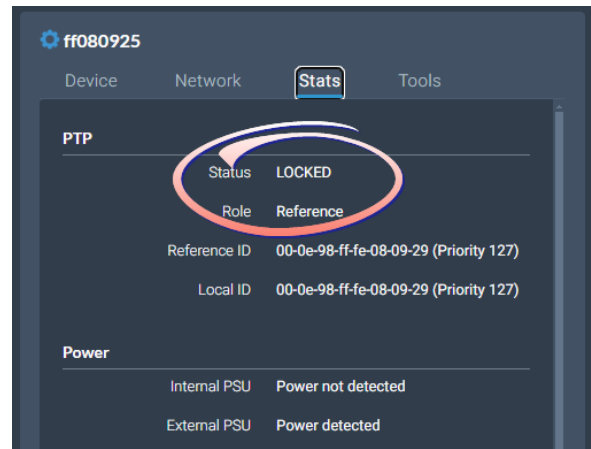

ff080925

Device Network **Stats** Tools

PTP

Status	LOCKED
Role	Reference
Reference ID	00-0e-98-ff-fe-08-09-29 (Priority 127)
Local ID	00-0e-98-ff-fe-08-09-29 (Priority 127)

Power

Internal PSU	Power not detected
External PSU	Power detected

For information and history, also look in the event log: **Status > Event Log.**

11 Configuring from the CCM

This chapter describes how to use the CCM to set up, configure and monitor your intercom system. It contains the following sections:

11.1 Configuring Station Settings	94
11.2 Adding IP Transceivers	100
11.3 Registering Beltpacks	101
11.4 Channels and Groups	103
11.5 Managing Channels	105
11.6 Managing Groups	110
11.7 Managing Roles	116
11.8 Setting up GPIOs and Logic Events	124
11.9 Monitoring System Status	127
11.10 Monitoring the Event Log	131
11.11 Monitoring the Logic Page	132

11.1 Configuring Station Settings

To configure the Base Station, navigate to **Hardware>Hosts**.

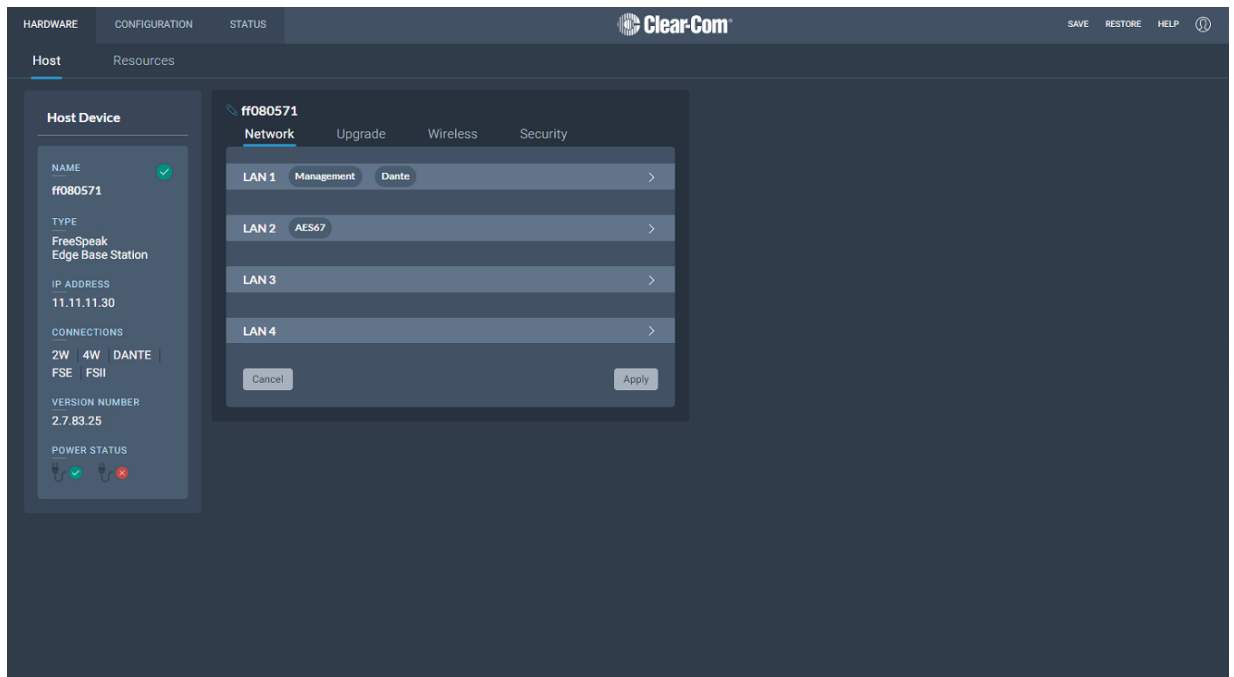

Here you can:

- Configure the network
- Upgrade the Base Station and connected resources
- Change the following wireless beltpack system settings:
 - Beltpack administration pin numbers
 - FS Edge wireless region (important for system compliance)
 - FSII battery type, if you are not using the supplied Li-ion batteries you may use Alkaline or NiMH type batteries
- Configure security settings

Click the pencil icon  to name your Base Station .

11.1.1 Configuring the Network

After changing the network configuration, you must click **Apply** or [Enter] key.

For information see [LAN Configuration Rules on page 89](#).

The screenshot displays the network configuration interface for LAN 1. At the top, the device ID 'ff080238' and the 'Network' tab are visible. A callout points to the 'Network tab'. Below the tab, the 'LAN 1 Management' section is active. A dropdown menu is open, showing 'Management' (selected), 'AES67', and 'Dante'. A callout points to this dropdown with the text 'Click dropdown'. Below the dropdown, the 'Management' section shows a 'Mode' selector with 'Dynamic' (selected) and 'Static' options. A callout points to this selector with the text 'Select either static or dynamic (default)'. The 'IP Address' field is set to '11.11.11.30', and the 'Subnet Mask' field is set to '255.255.0.0'. Other fields for 'Gateway', 'Primary DNS', and 'Secondary DNS' are empty. At the bottom, there are 'Cancel' and 'Apply' buttons. A callout points to the 'Management' traffic type selection with the text 'Select traffic type'.

11.1.2 Upgrading

To upgrade the Base Station and connected resources:

1. Select the **Upgrade** tab.
2. **Select File** then navigate to where the upgrade file is stored on your computer.
3. Select the file and when the **Upgrade** button lights, click it. This begins the upgrade process.

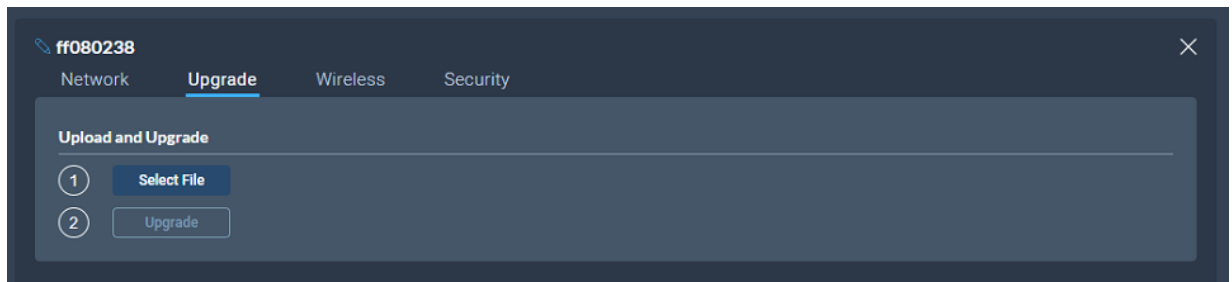

Device to upgrade	File extension
Base Station, FS II IP TCVR, FS Edge IP TCVR	.ccf
FS II beltpack, FS II E1 TCVR	.fww
FS Edge beltpack	.ccu

Note: *Over the Air (OTA) upgrade is not available for the FreeSpeak Icon beltpack. FreeSpeak Icon beltpacks are upgraded over USB connection using a separate utility.*

11.1.3 Setting Up the Wireless Beltpack System

Select the **Wireless** tab.

The screenshot shows the configuration interface for system **ff080925**. The **Wireless** tab is selected. The settings are organized into three sections:

- General:**
 - Administration PIN: 1111
 - System ID: 925
 - BP Role List Sorting: Role Number
- FreeSpeak Edge:**
 - Edge Wireless Region: US
 - Excluded Channel(s): Unassigned
- FreeSpeak Icon & FreeSpeak II:**
 - Splitter/Transceiver 1: RJ45
 - Splitter/Transceiver 2: RJ45
 - Audio RF Filter: Disabled
 - AA Battery Type: Alkaline
 - Over The Air (OTA) PIN: 0000

From the Wireless tab, you can set or view the following System and Station settings.

System

- The administration pin for local admin to access locked configuration menus on wireless beltpacks and keypanels
- System ID. This is used to differentiate this system's RF signals from those of other systems
- Beltpack role list sorting:
 - Role number
 - Alphabetical

FreeSpeak Edge

- The wireless region for your FreeSpeak Edge beltpacks. The region set here **MUST** match the hard-coded setting on your Edge transceiver or the system will not work. You will see an error flag in the **Status** page if the regions do not match. Please contact your Clear-Com representative if you have any difficulties with this.
- Select from a list of 5 GHz channels that you can exclude and prevent transceivers from using
- Scan all transceivers. Use this feature to scan the local 5 GHz RF space. All available channels will be scanned, and traffic reported. Each transceiver will be scanned and the system will report on the RF performance of selected channels. To view results of the scan and adjust channels, navigate to: **Hardware > Resources > Transceivers > [select a transceiver to view] > Wireless Channels**

The screenshot shows the configuration page for device **ff080274**. The **Wireless** tab is selected. The interface is divided into three main sections: **General**, **Freespeak Edge**, and **Freespeak II**.

- General**: Administration PIN (1111), System ID (274), BP Role List Sorting (Role Number).
- Freespeak Edge**: Edge Wireless Region (EU), Excluded Channel(s) (Unassigned), 5GHz Scan All button, and Auto Select All button.
- Freespeak II**: Splitter/Transceiver 1 (RJ45), Splitter/Transceiver 2 (RJ45), Audio RF Filter (Enabled), AA Battery Type (Alkaline), and Over The Air (OTA) PIN (0000).

Three callout boxes provide instructions:

- Wireless region**: Points to the Edge Wireless Region dropdown menu.
- Select any channels for exclusion**: Points to the Excluded Channel(s) dropdown menu.
- Scan and select transceivers. Only visible when one or more Edge transceivers are registered**: Points to the 5GHz Scan All and Auto Select All buttons.

FreeSpeak II and FreeSpeak Icon

- Splitter/Transceiver ports: select RJ45 or Fiber connectivity for each port
- Audio RF Filter (improve resilience to corrupt wireless transmission) - for use with E1 1.9GHz transceivers only
- AA Battery type. You can choose not to use the Li-ion batteries supplied with the belt packs, in which case you must specify battery type here. Choose between:
 - Alkaline (AA) batteries (default setting)
 - NiMH batteries for use in settings where air pressure is an issue (for instance on an underwater site).
- The OTA pin you need for over-the-air (OTA) registration of your FreeSpeak II and FreeSpeak Icon belt packs.

11.2 Adding IP Transceivers

Note: To add E1 transceivers, see [Connecting Transceivers Over E1 on page 50](#).

To add IP transceivers:

1. Navigate to **Hardware > Resources** and select **Add Resource**. The following screen appears.

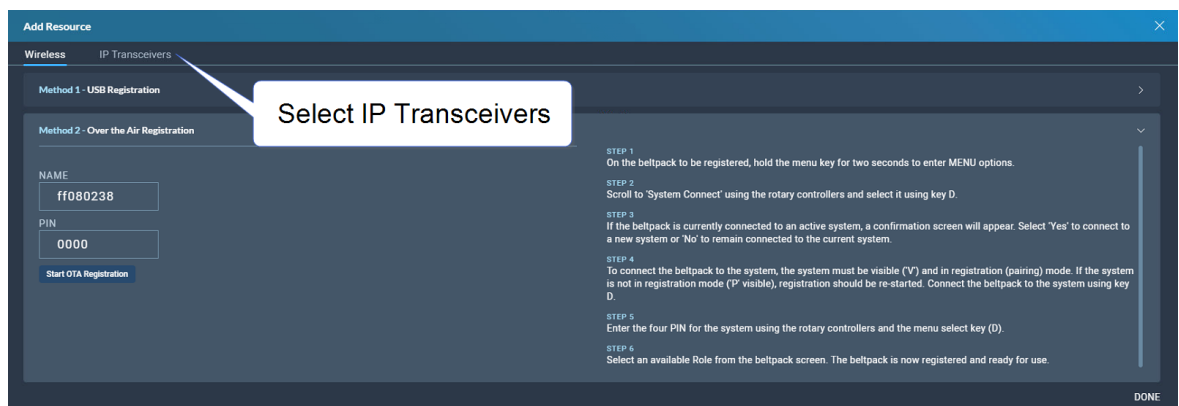

2. Select **IP Transceivers**. The following screen appears:

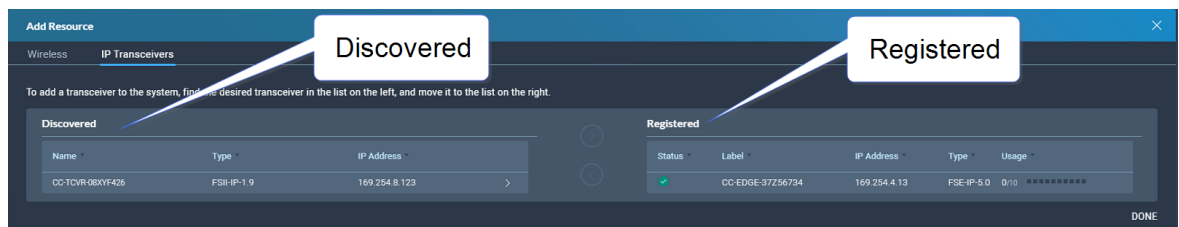

3. Select the transceiver that you want to register from the left-hand area of the screen, and click the right-hand arrow.

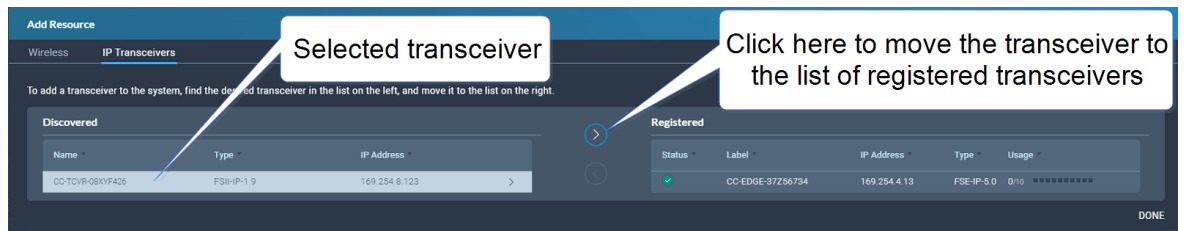

The selected transceiver appears in the right-hand list of registered transceivers.

11.3 Registering Beltpacks

Before you can use a beltpack, you must register it. This enables the FreeSpeak Edge Base Station to associate the beltpack with roles and assigned keys.

You can register a beltpack in two ways:

- By USB cable. When registering a beltpack in this way, a role that assigns keys to the beltpack is automatically created and fixed to the beltpack. The role can be edited as required in the **Configuration > Roles** page of the CCM.
- Over The Air (OTA). When you register a beltpack in this way you must create a role for it manually in **Configuration > Roles** before the beltpack can connect.

11.3.1 Registering a beltpack by USB cable

This method of registering beltpacks is recommended for fast and easy set up.

To register a beltpack using a USB cable, connect a beltpack to Base Station using a USB A to micro USB B (FSII) / USB C (FSIC, FSE) cable. The beltpack can be powered on either before or after connection. The Base Station will show 'Beltpack [ID] is now registered' in the front menu screens.

Note: *When beltpacks are registered in this way, a role with two channels (1 and 2) is automatically generated and applied to the beltpack. Roles can be edited at any time in the **Configuration** page of the CCM.*

11.3.2 Registering a beltpack OTA

To register a beltpack using OTA:

1. Navigate to **Hardware > Resources** and click **Add Resource**. The following screen appears:

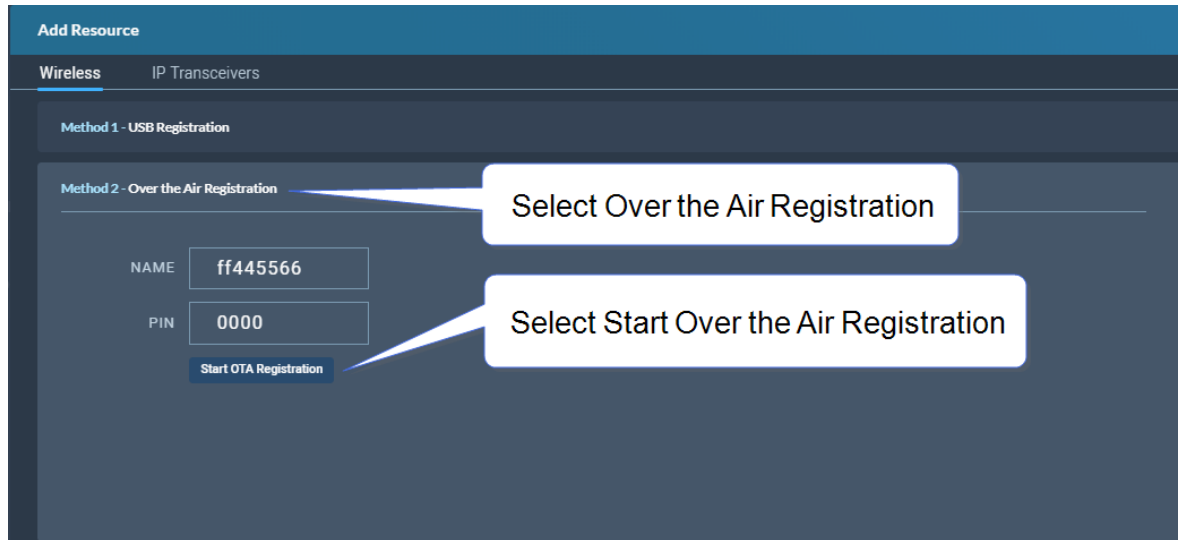

2. Click **Start OTA Registration**.

Note:

A timer is started indicating how long the system is open for registration. You can close OTA registration on the system at any point.

11.3.3 Unregistering a beltpack

To unregister a beltpack, navigate to **Hardware > Resources > Endpoints** (click the down arrow to see all connected Endpoints). Select an Endpoint by clicking on it. Select **Unregister**.

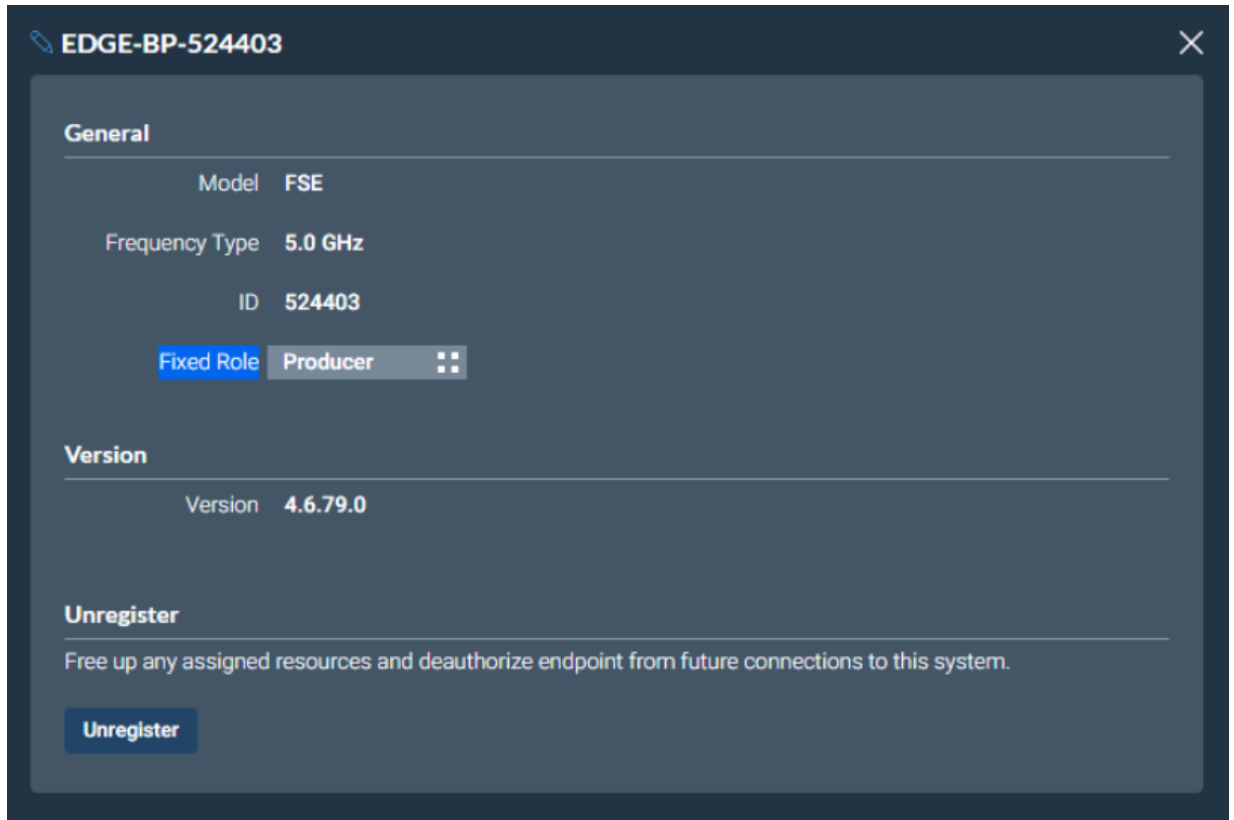

11.4 Channels and Groups

Channels and groups are both essentially digital containers for audio sources, allowing communication between members.

11.4.1 Channels

A Channel operates as an intercom Partyline or conference. All members can talk to and listen to all other members, as long as they have keys to do so.

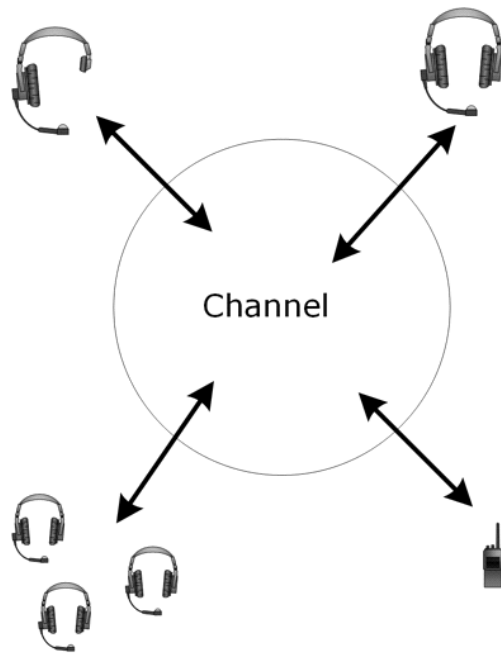

The default key behavior setting for a wireless beltpack in a Channel is **Talk and Forced Listen**. For more information, see **Key Behavior**.

11.4.2 Groups

A Group configuration enables an announcement or broadcast to a number of members at the same time.

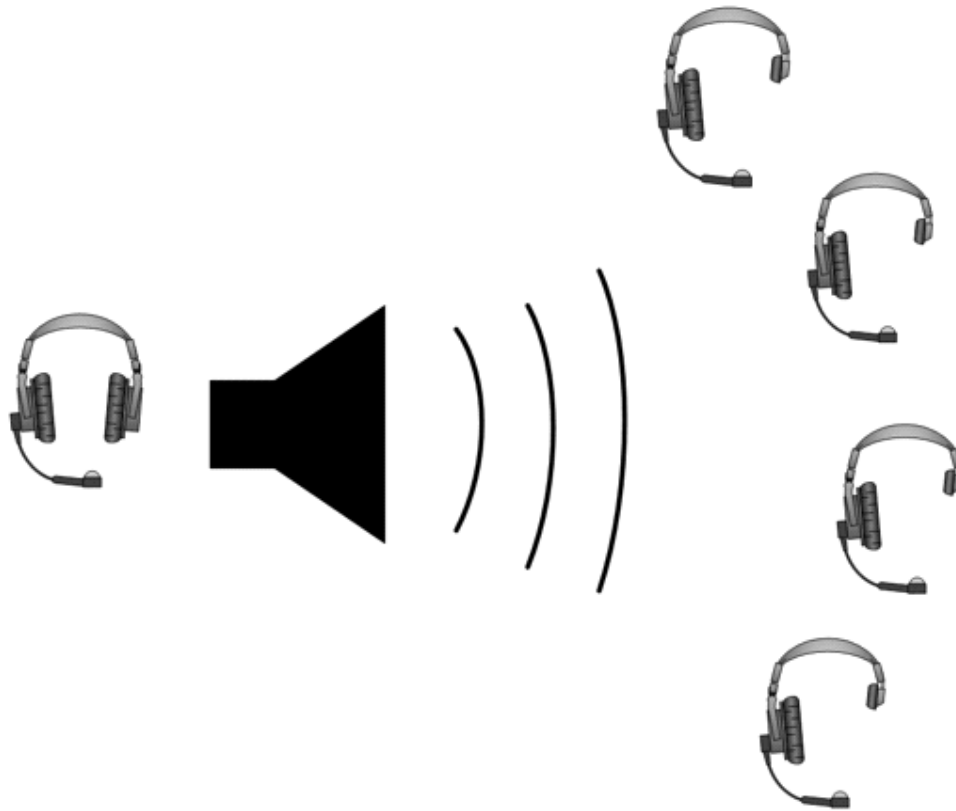

A group member can reply directly to the announcer using the **Reply** key. The other group members will not hear this.

To set up a group, you must first put the members in the Group. Then, when the members are in the Group, you can set up a key or keys to talk to it.

11.5 Managing Channels

From the **Channels** tab, you can:

- View existing channels and add or remove new channels.
- View existing ports, and add or remove ports from the channel.

To access the **Channels** screen, navigate to **Configuration > Channels**. The Channels screen appears.

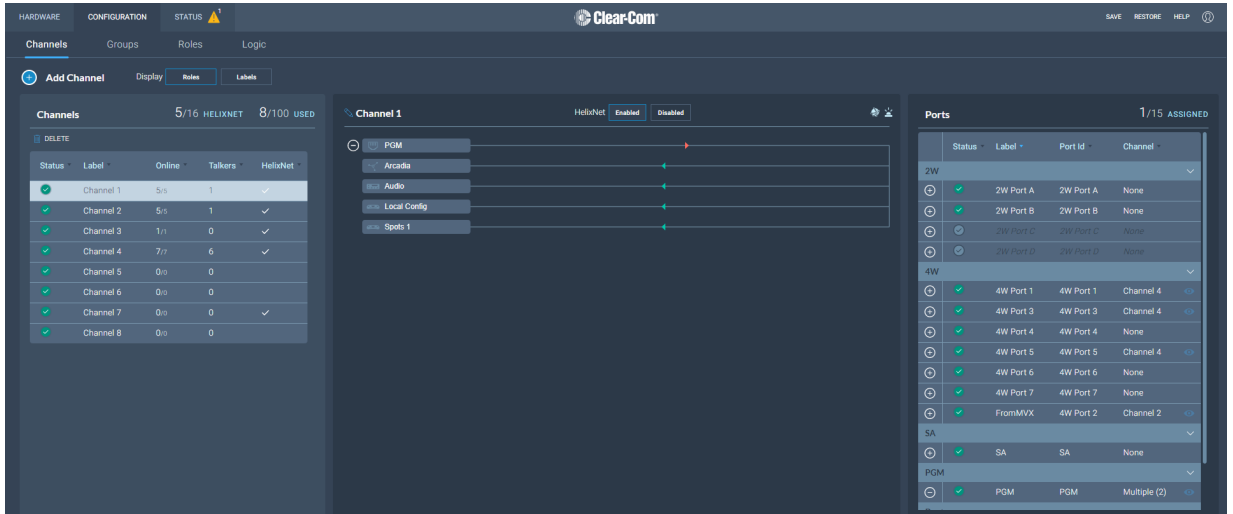

Viewing Information About a Channel

When you open the **Channels** screen, the left-hand panel displays a list of all the channels that are currently present. The following information is displayed for each channel.

The screenshot shows the 'Channels' screen with a table of channels. Callout boxes provide explanations for various elements:

- Delete Icon:** Click this icon to delete a channel (points to the trash icon).
- Channel Count:** The channel count indicates that eight out of a maximum of 100 channels (points to '8/100 USED').
- Status:** A green tick mark indicates that all configured ports are connected (points to the green checkmark in the Status column).
- Label:** This is a label for the channel (points to 'Channel 1' in the Name column).
- Talkers:** This indicates how many users are talking on this channel (points to '1' in the Talkers column).
- Online:** This indicates how many configured ports are connected (points to '2/2' in the Online column).

Status	Id	Name	Online	Talkers
✓	1	Channel 1	2/2	1
✓	2	Channel 2	0/0	0
✓	3	Channel 3	0/0	0
✓	4	Channel 4	0/0	0
✓	5	Channel 5	0/0	0
✓	6	Channel 6	0/0	0
✓	7	Channel 7	0/0	0

Status

A green tick mark indicates that all the ports that are configured for the channel are connected. Otherwise, a warning triangle is shown.

Name

This field contains a label that enables you to identify the channel.

Note: A label can contain up to 10 characters. You can edit this label from the center panel.

Online

This indicates how many of the total channel members are online.

Talkers

This indicates how many members have active talk routes on this channel.

11.5.1 Display Roles or Labels

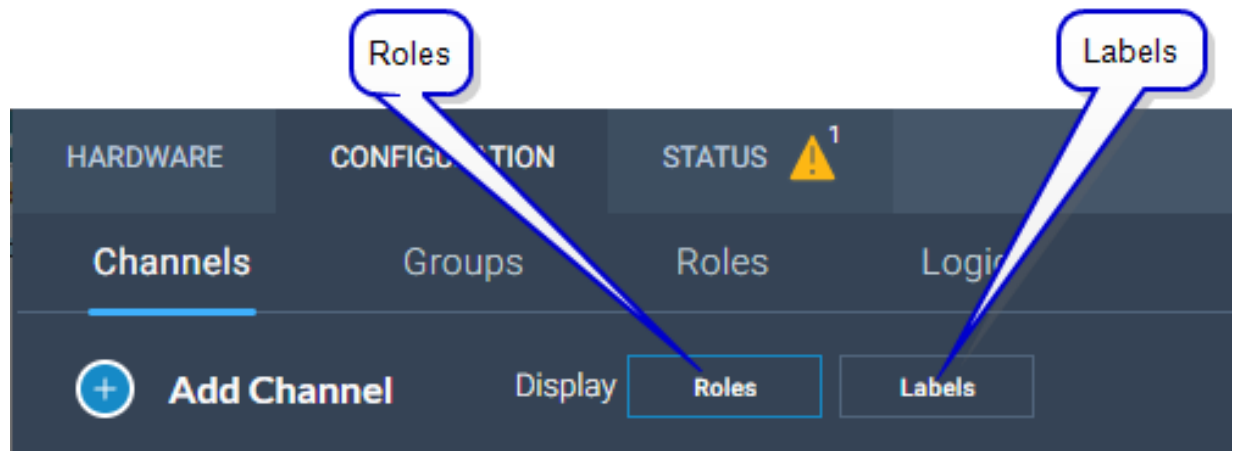

Display Roles

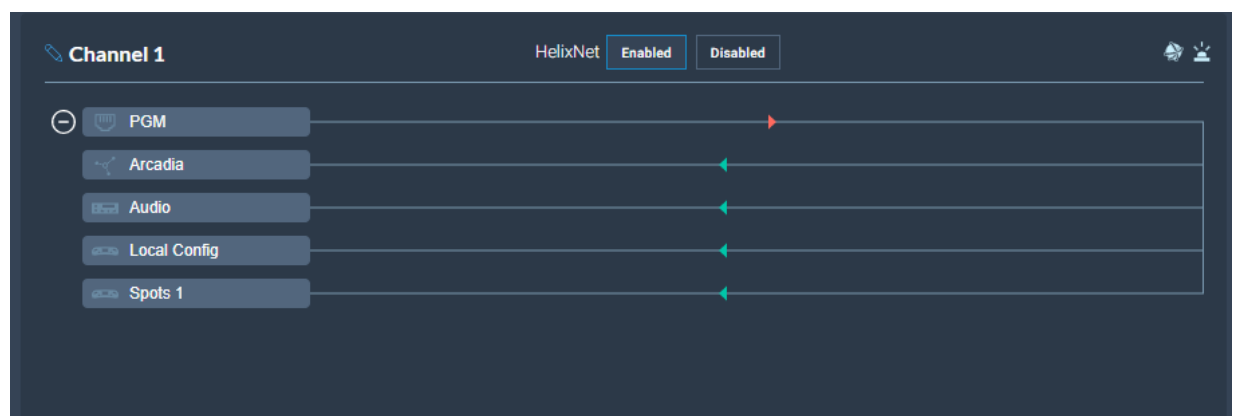

Display Labels

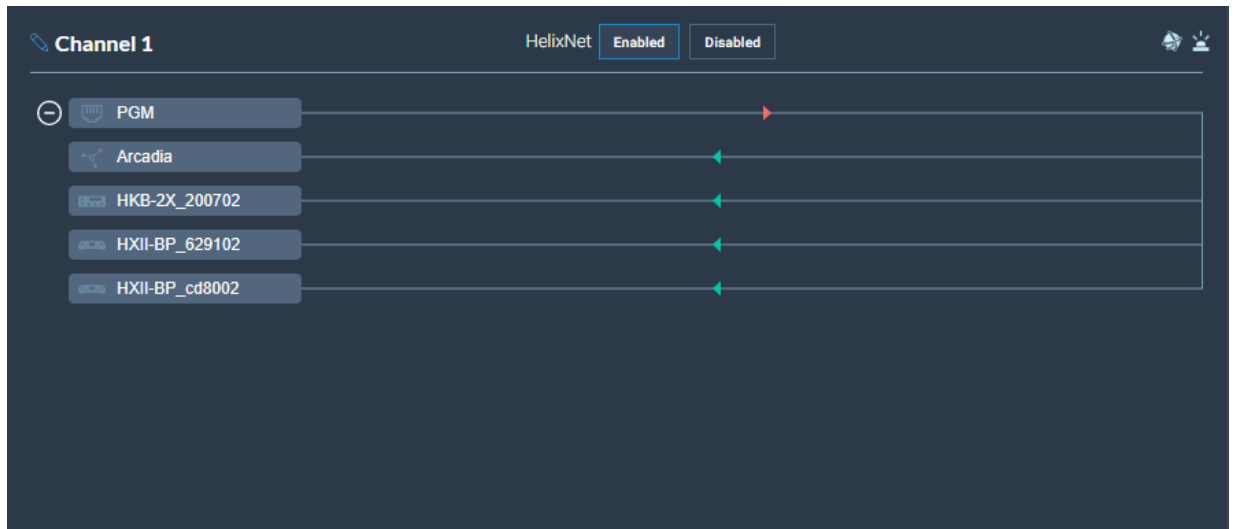

11.5.2 Adding a New Channel

To add a new channel:

1. Click the new channel icon . A new entry appears in the list of added channels.

Note: You can only add new channels up to a maximum number (100).

2. Add any required ports to the channel.

11.5.3 Adding Ports to a Channel

To add ports to a channel:

1. From the **Channel** panel, select the channel in which the port is to be added.
2. From the **Ports** panel, click the add port icon  of the port that you require.

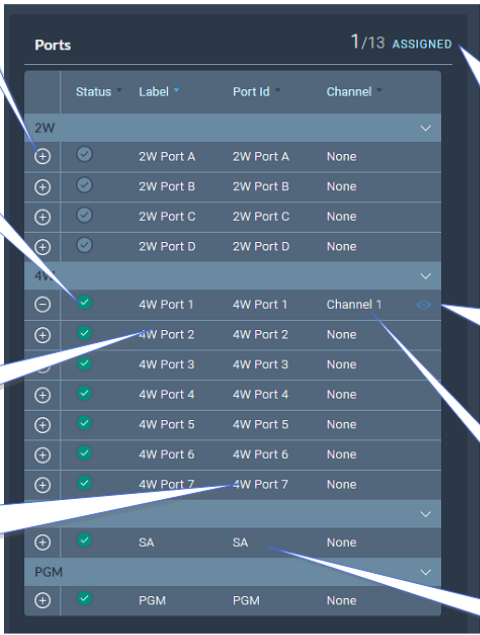

Click here to add this port to a channel

A green checkmark indicates that the port is online

This is a label that helps you to identify the port

This identifies the port. Changing the label does not affect the Port Id

This indicates how many of the total number of ports are assigned to the currently selected channel

Click on the eye icon to highlight the channels that the port is assigned to

This is the name of the channel that the port is currently assigned to

Stage Announce

Status	Label	Port Id	Channel
2W			
	2W Port A	2W Port A	None
	2W Port B	2W Port B	None
	2W Port C	2W Port C	None
	2W Port D	2W Port D	None
4W			
	4W Port 1	4W Port 1	Channel 1
	4W Port 2	4W Port 2	None
	4W Port 3	4W Port 3	None
	4W Port 4	4W Port 4	None
	4W Port 5	4W Port 5	None
	4W Port 6	4W Port 6	None
	4W Port 7	4W Port 7	None
SA			
	SA	SA	None
PGM			
	PGM	PGM	None

The port is now added to the channel, and appears in the list of ports in the center panel.

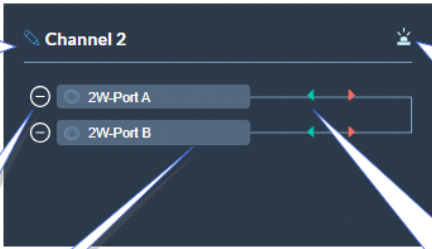

Click here to edit the channel label

Click here to remove the port from the channel

This is the label of the port

When this is lit it indicates that a call signal is active in this channel

The green arrows indicate active listen (left arrow). The red arrows indicate active talk (right arrow).

11.5.4 Removing Ports From a Channel

To remove a port from a channel:

1. From the **Channels** panel, select the required channel.

2. Click the remove icon  of the port that you want to remove.

The port is removed.

11.5.5 Deleting a Channel

To delete a channel:

1. From the **Channels** panel, select the channel that you want to delete.
2. Remove all the ports from the channel

Note: *If you do not remove the ports, you will be prompted to do so in step 3.*

3. Click the **More Actions** icon , and select **Delete**.

11.6 Managing Groups

From the **Groups** tab, you can:

- View existing groups and add or remove new groups.
- View existing ports, and add or remove ports from the groups.

Note: *Beltpacks are added to Groups in the Roles page.*

To access the **Groups** screen, navigate to **Configuration > Groups**. The Groups screen appears:

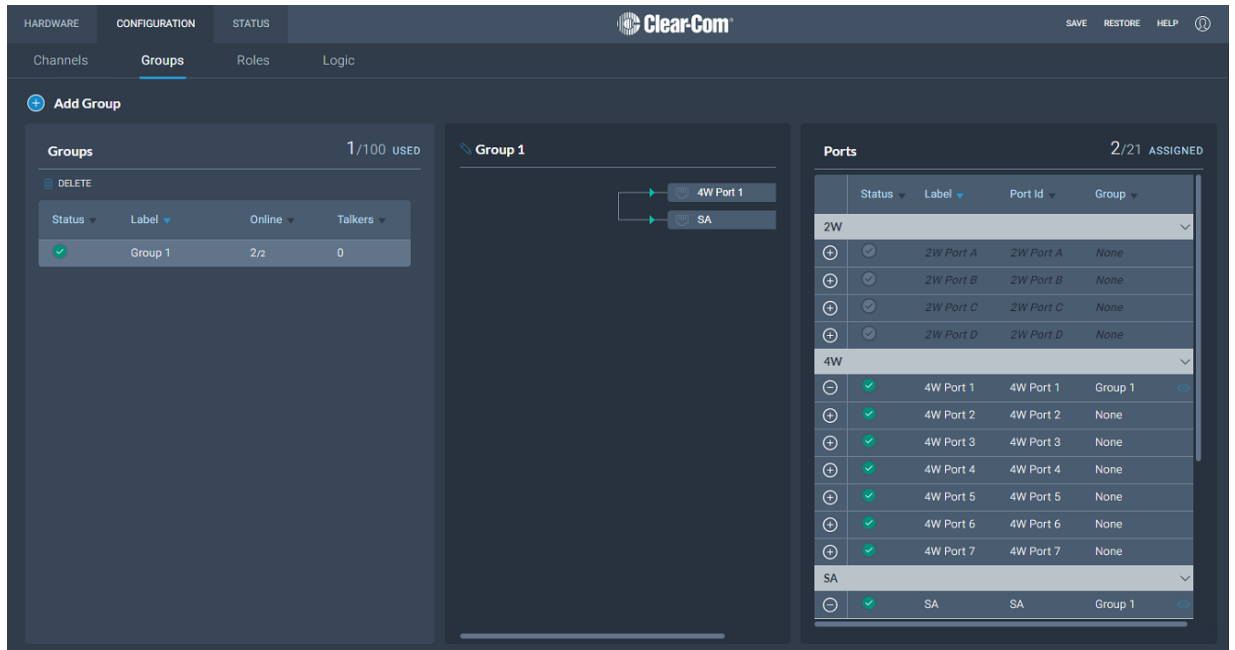

11.6.1 Viewing Information About a Group

When you open the **Groups** screen, the left-hand panel displays a list of all the groups that have been created. The following information is displayed for each group.

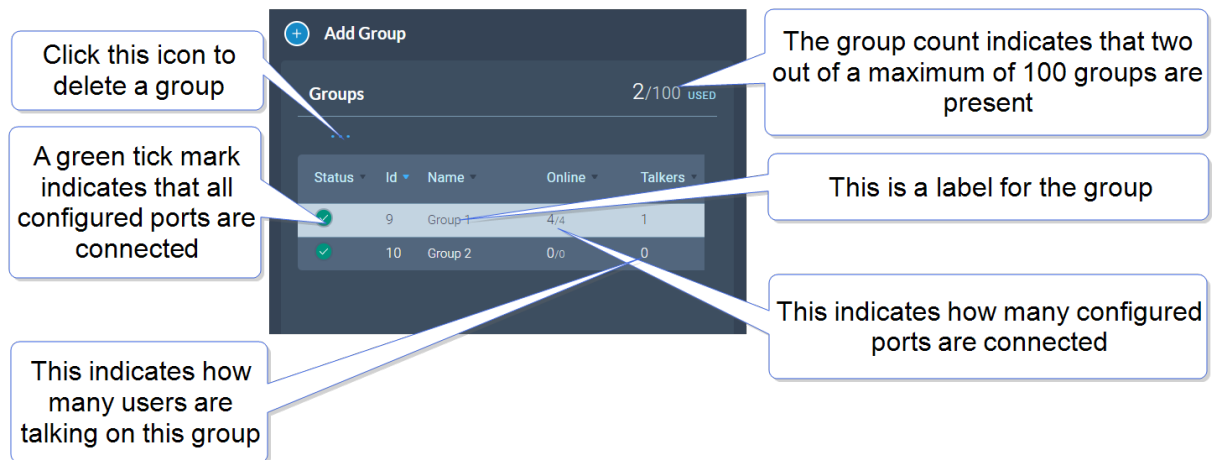

Status

A green tick mark indicates that all the ports that are configured for group are connected. Otherwise, a warning triangle is shown.

Name

This field contains a label that enables you to identify the group.

Note: A label can contain up to 10 characters. You can edit this label from the center panel.

Online

This indicates how many of the total group members are online.

Talkers

This indicates how many FreeSpeak beltpacks or logic-routed ports have active talk routes on this group.

11.6.2 Adding a New Group

To add a new group:

1. Click the new group icon . A new entry appears in the list of added groups.
***Note:** You can only add new groups up to a maximum number (100).*
2. You can now add any required ports and members to the group.

11.6.3 Adding Ports and Roles to a Group

To configure a group you must first put the members in the group. These can be ports and/or roles. When you have done this you will configure a talk key to the group (group administrator).

Adding Ports to a Group

1. From the **Group** panel, select the group in which the port is to be added.
2. From the **Ports** panel, click the add port icon  of the port that you require.

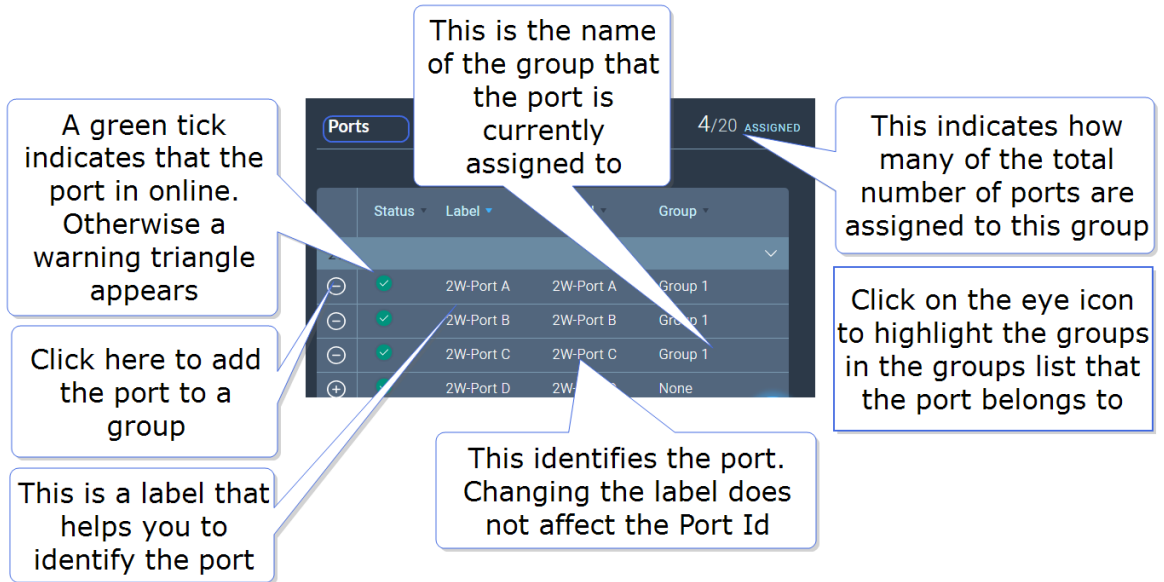

A green tick indicates that the port is online. Otherwise a warning triangle appears

Click here to add the port to a group

This is a label that helps you to identify the port

This identifies the port. Changing the label does not affect the Port Id

This is the name of the group that the port is currently assigned to

This indicates how many of the total number of ports are assigned to this group

Click on the eye icon to highlight the groups in the groups list that the port belongs to

Status	Label	Port	Group
✓	2W-Port A	2W-Port A	Group 1
✓	2W-Port B	2W-Port B	Group 1
✓	2W-Port C	2W-Port C	Group 1
	2W-Port D	2W-Port D	None

The port is now added to the group, and appears in the list of ports in the center panel.

Adding Roles to a Group

1. In the **Roles** page, select the role you wish to add to the group.
2. On the left side of the screen, select **Group Membership**.

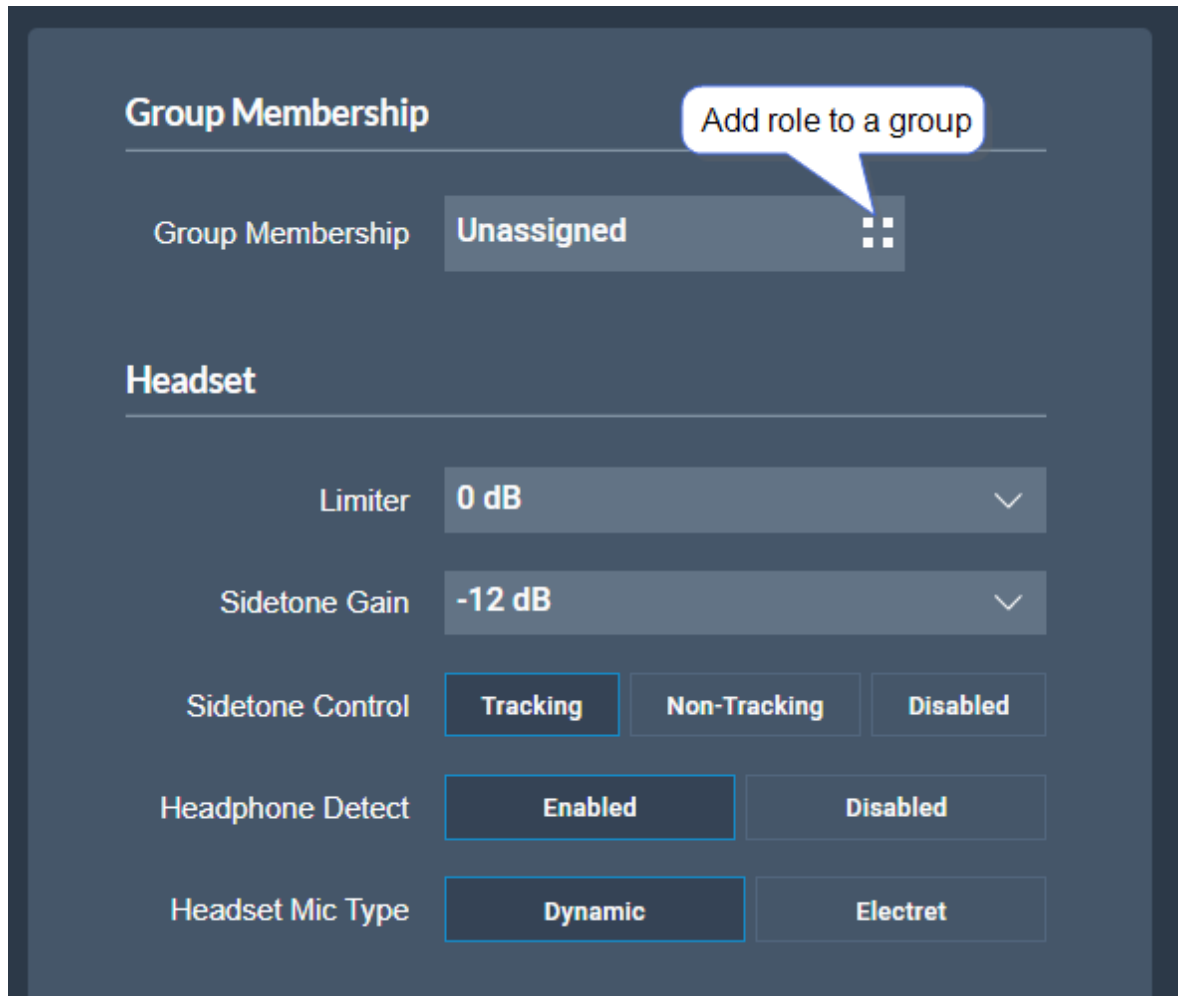

Configuring a Talk Key to the Group

1. In the **Roles** page, select the role you want to talk to the group.
2. Configure a talk key to the group (Talk Only)

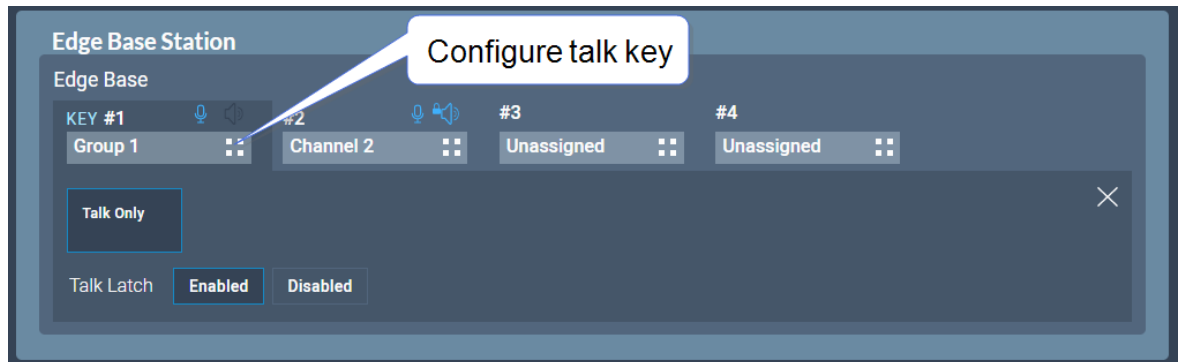

When you have configured members and a talk key to a group, you will see the group by selecting it in the **Groups** page. The group administrator will talk to the whole group. The group members can talk directly back to the group administrator using the **Reply** key. This communication will not be broadcast to the group, only the administrator will hear.

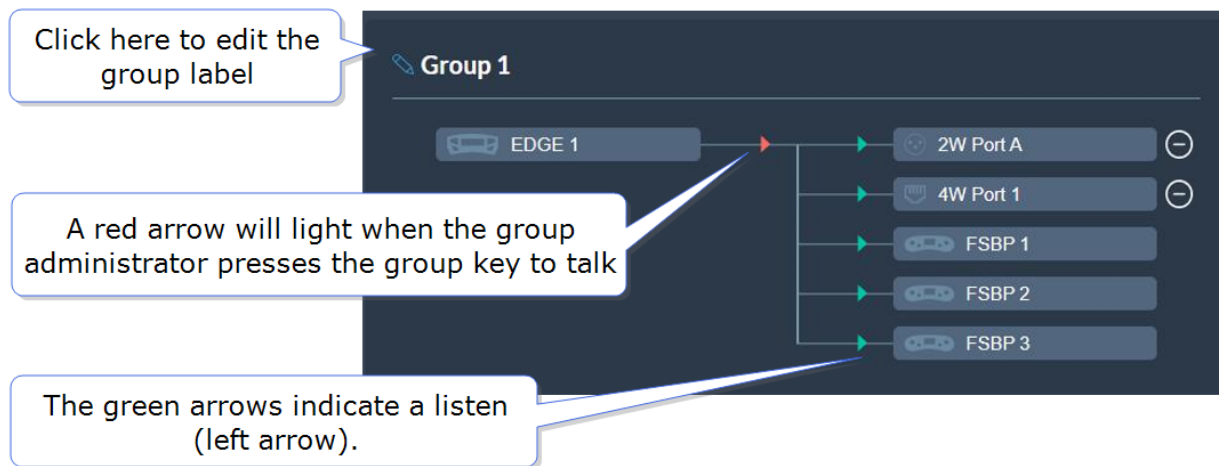

11.6.4 Removing Ports from a Group

To remove a port from a group:

1. From the **Groups** panel, select the required group.

2. Click the remove icon  of the port that you want to remove.

The port is removed.

11.6.5 Deleting a Group

To delete a group:

1. From the **Groups** panel, select the group that you want to delete.
2. Remove all the ports from the group

Note: *If you do not remove the ports, you will be prompted to do so in step 3.*

3. Click the trash can icon. The group is deleted.

11.7 Managing Roles

Roles are used to control the audio configuration and other settings for beltacks and other devices.

From the **Roles** page, you can view, add, clone, edit and delete roles.

When creating roles, roles can be:

- Added (role is based on the template role)
- Cloned (role is based on any selected role)

When working with FreeSpeak (4 key or 8 key), a role must be created for each beltack or device that you use. This relationship is 1:1. If you want the same settings for multiple beltacks, you may decide to clone an existing role.

You can create a role that can be used on either a 4 key or an 8 key beltack. In this case, you will configure two separate audio configurations, one for each beltack type. This role can only be in use on one beltack at a time.

11.7.1 Viewing Roles

To view roles, navigate to **Configuration > Roles**. The following screen appears.

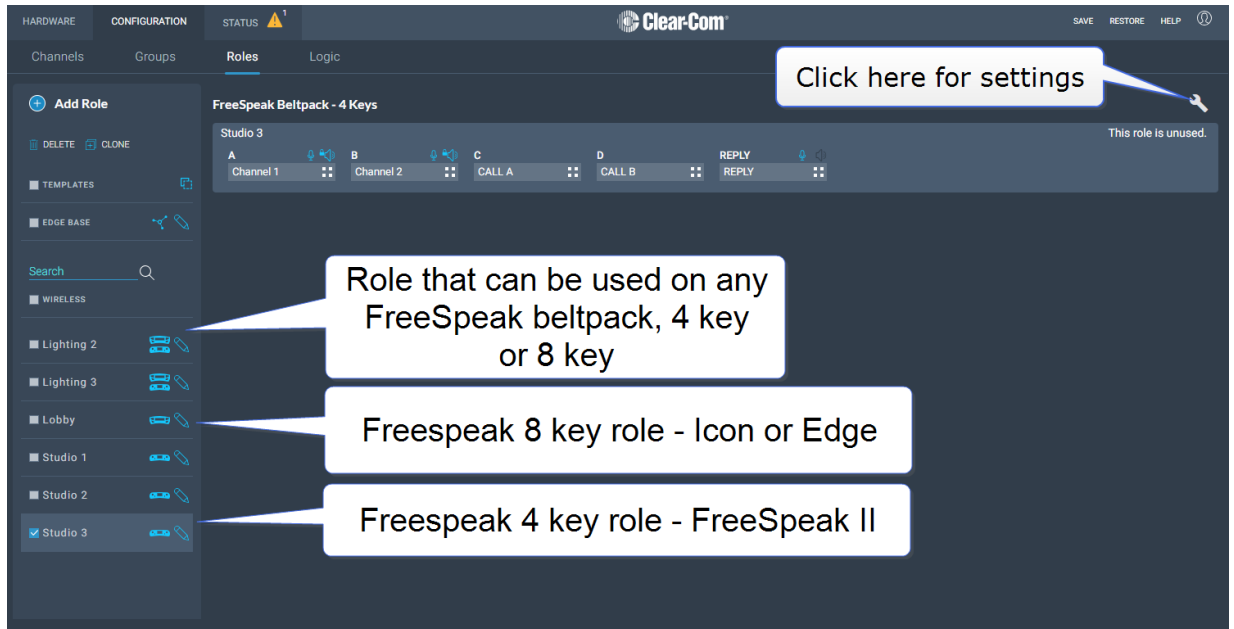

A list of roles appears on the left-hand side of the screen.

11.7.2 Role Templates

When you add roles, a new role is always created from a template role. Template roles are editable. If you edit a template role, any new roles created from it have the edited settings.

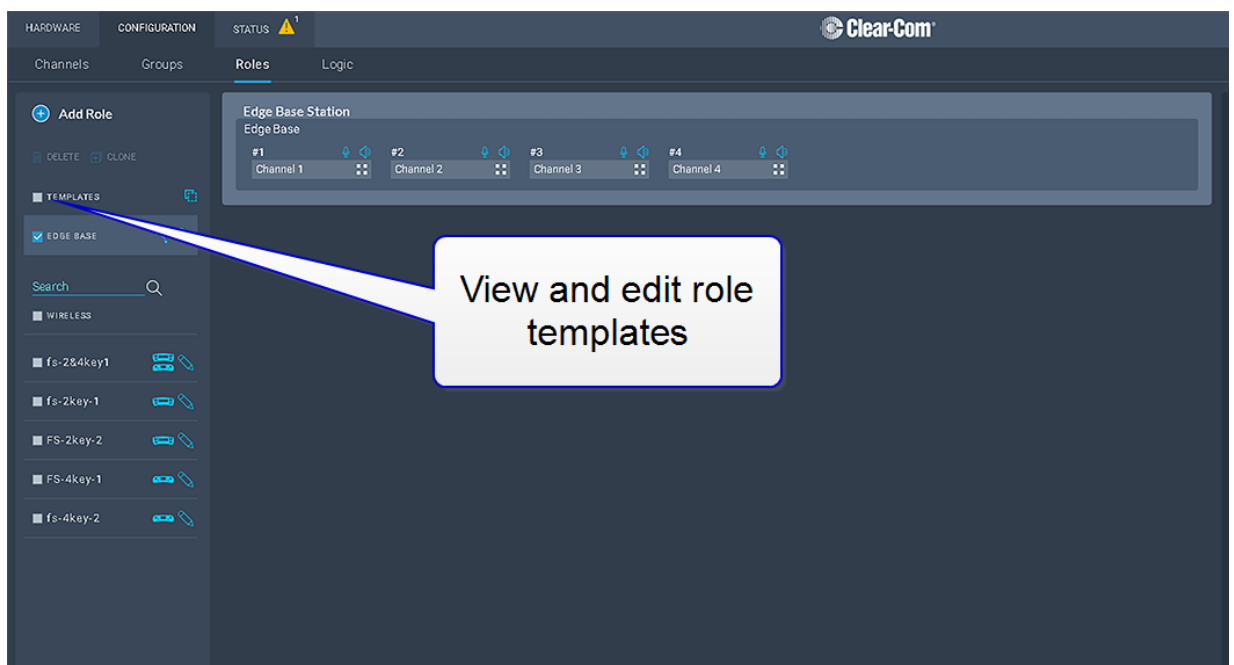

Select a role template to edit the settings.

To reset template roles to default settings, reset the Base Station to factory defaults.

Note: *The role templates you see depend on which feature licenses you have on the Base Station.*

11.7.3 Adding Roles

To add roles:

1. Navigate to **Configuration > Roles**.

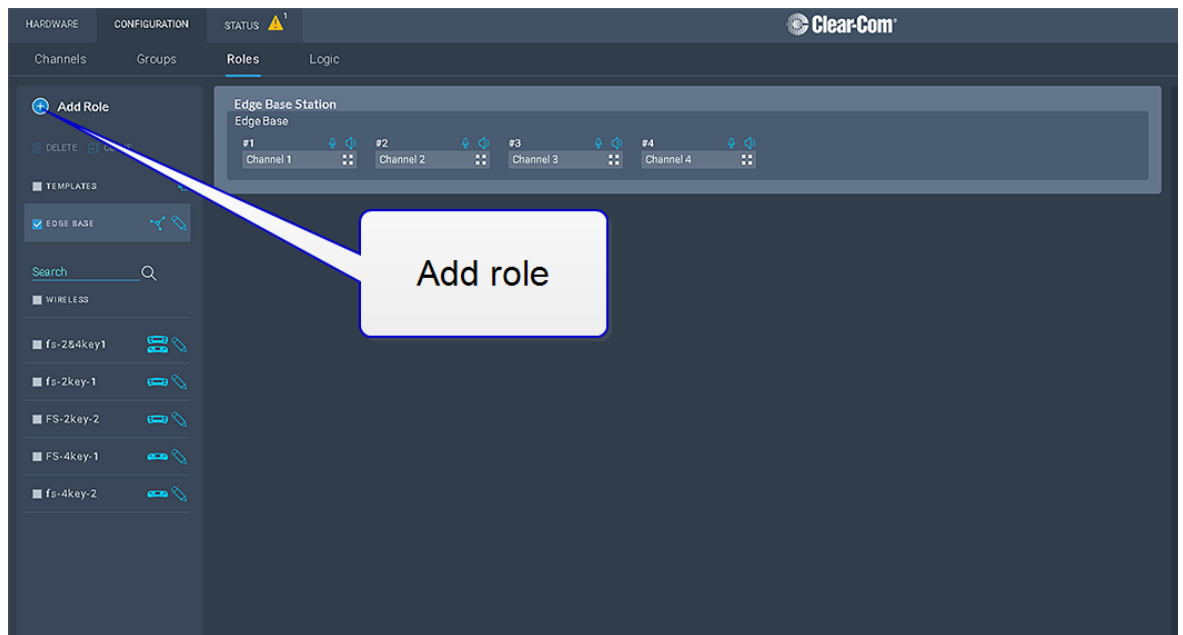

2. Click **Add Roles**. The following screen appears.

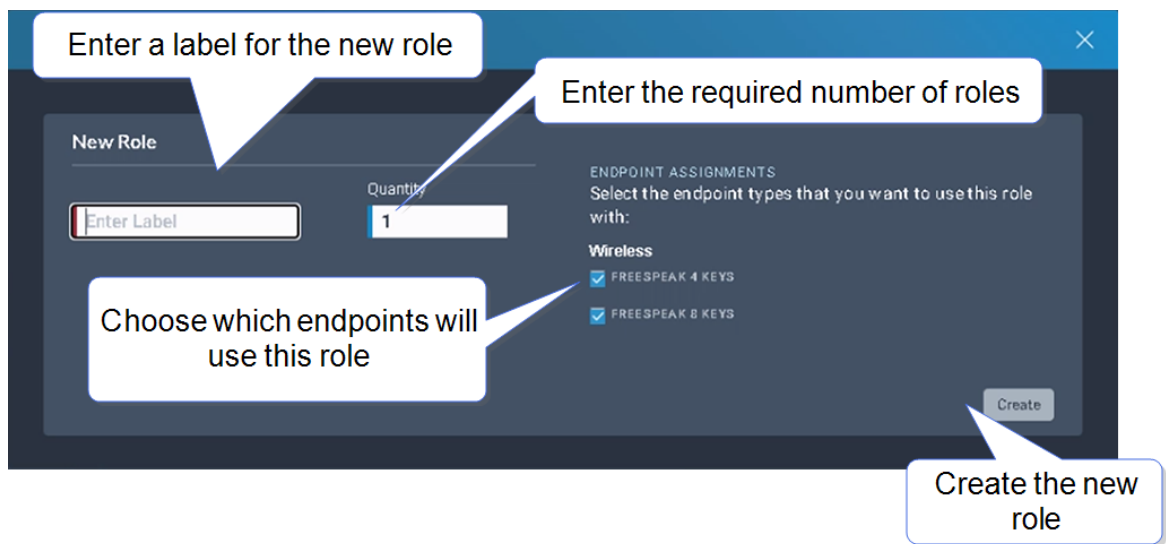

3. Enter a label for the role, the number of roles required and choose which endpoints will use this role (FS II, FS Edge, FS Icon, all FS type beltpacks).

Note: When creating multiple roles, the system will add an incrementing numerical suffix to the role name. Roles names must be unique.

4. Click **Create**. The new role appears in the list of roles in the left-hand side of the **Roles** screen.

Note: You can also edit the label and endpoint assignments from the icons that appear beside each role in the left-hand side of the screen.



11.7.4 Editing Role Key Assignment

1. Navigate to **Configuration > Roles** and select required role on the left of the screen.
2. Click on the small white squares.

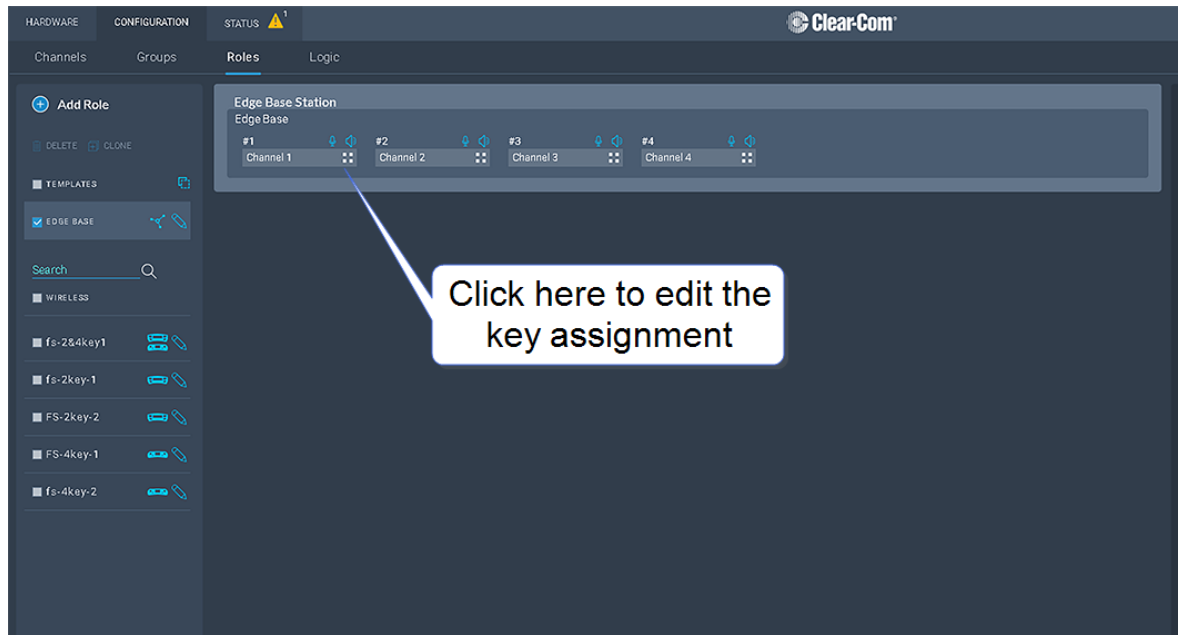

The key assignment screen appears.

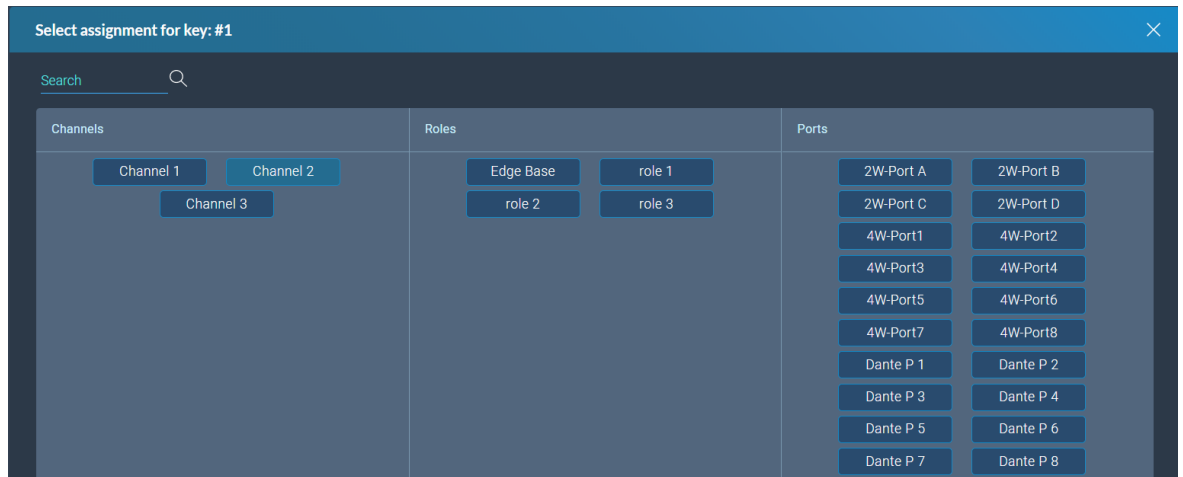

3. Click to select the required audio source.

11.7.5 Configuring Role Settings

To configure the settings for a role:

1. Navigate to **Configuration > Roles**, and select the required role from the list of roles in the left-hand side of the screen.

2. Click the spanner icon  to view and edit **Settings**
3. From the **Settings** panel, scroll to the required setting.
4. Edit the setting as required.

11.7.6 Cloning Roles

To clone roles:

1. Navigate to **Configuration > Roles**, and select the role that you wish to clone from the list of roles in the left-hand side of the screen.
2. Click **CLONE**.

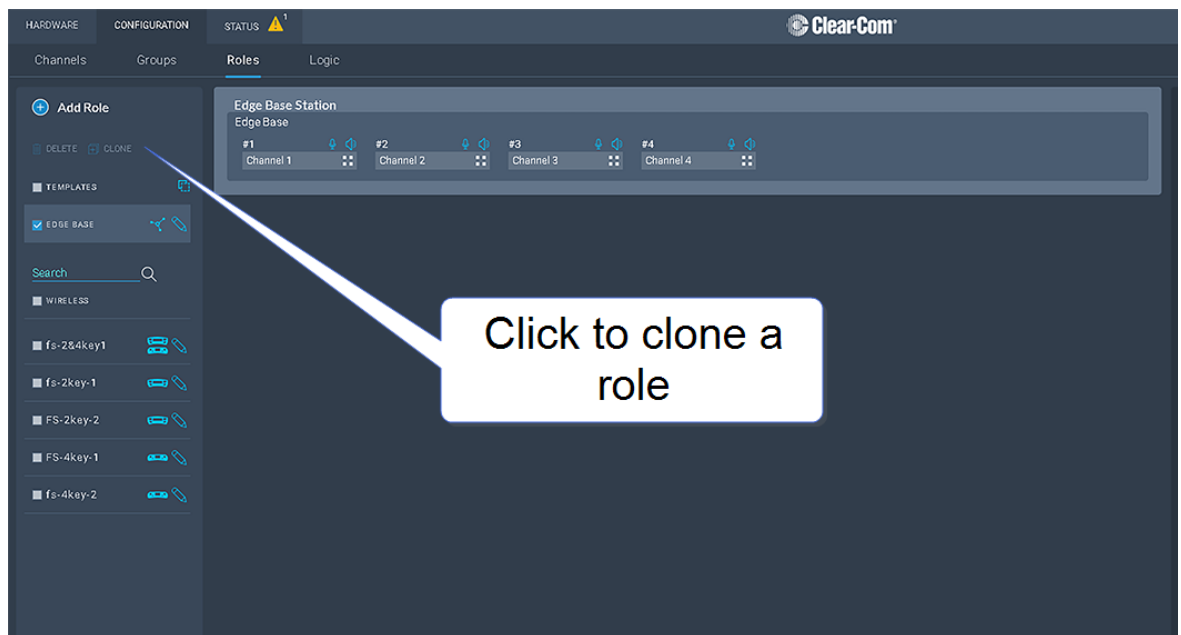

The role is cloned and added to the list of roles in the left-hand side of the screen.

11.7.7 Deleting Roles

To delete roles:

1. Navigate to **Configuration > Roles**, and select the role that you wish to delete from the list of roles in the left-hand side of the screen.
2. Click **DELETE**.

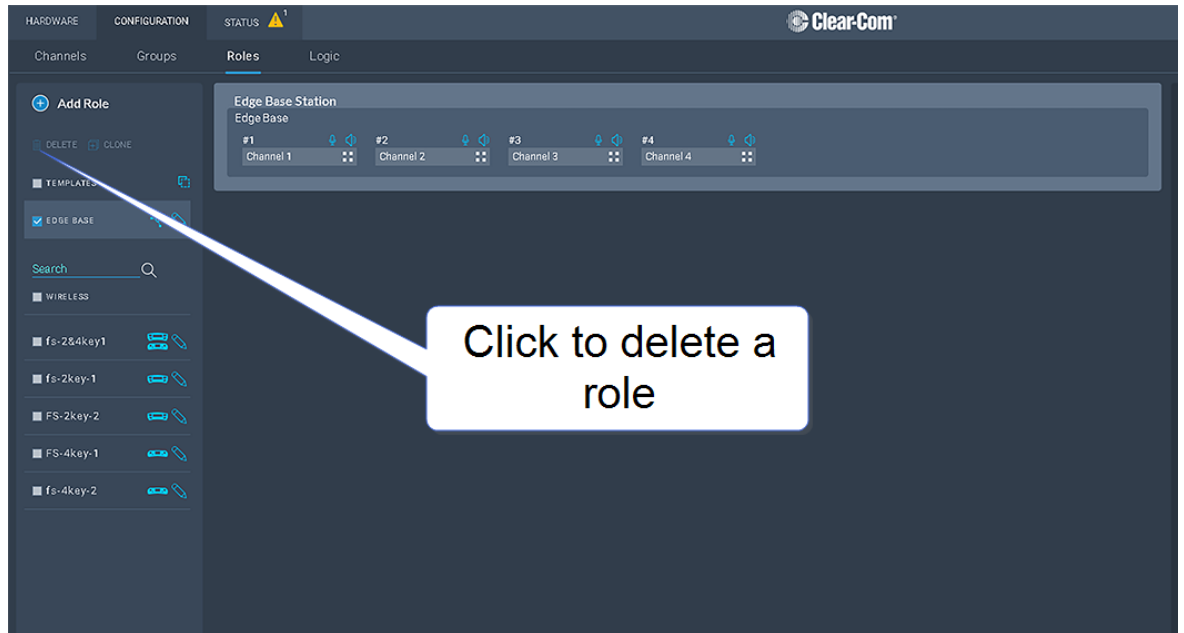

The role is deleted and removed from the list of roles in the left-hand side of the screen.

11.7.8 Setting Key Behavior

Audio keys can be set to different Talk and Listen states. These key behavior states apply to the keys on the Base Station and beltacks. Key behavior is configured in the **Roles** tab in the CCM.

Key Behavior Options	Resulting Audio Behavior
Talk-Only	Press key to talk. Key only controls talk.
Listen-Only	Press key to listen. Key only controls listen.
Talk and Listen	FreeSpeak Edge Base: Press listen or talk separately.
Dual Talk and Listen (FreeSpeak)	Press key to talk and listen. Listen latches on or off according to preference (quick tap to latch). The user can push and hold (PTT) to activate talk.
Force Listen	Permanent listen.
Talk and Forced Listen	Permanent listen, push key to talk.
Force Talk and Force Listen	Permanent listen and talk.
Talk Latch	Enabled (default setting)/Disabled
In-Use Tally	Enabled/ Disabled (default setting)

11.7.9 Fixed Roles

When a role is fixed to a beltack, a beltack user is forced to use that role. If a role is not fixed to a beltack, the user can chose from any available roles.

When you register beltacks via USB cable to the Station, an editable fixed role is created and applied to the beltack.

Roles can be fixed/unfixed in the CCM.

Navigate to: **Hardware > Resources > Endpoints** (select the down arrow to see all connected Endpoints). Select an Endpoint (beltack) by clicking it. Click to fix/unfix or change the role for this beltack.

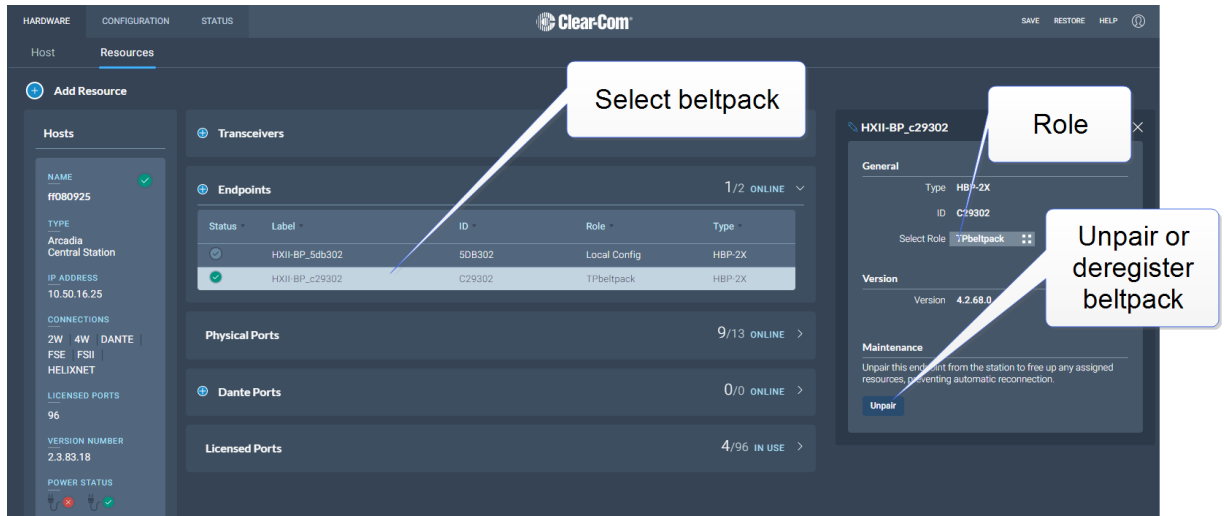

11.8 Setting up GPIOs and Logic Events

- 2 x GPIs
- 4 x GPOs
- Unlimited Logic Events
- Each GPI/GPO hosts up to 10 different events or actions. These actions can be turned off or on in the **Status > Logic** page of the CCM.
- 2 x DB 9F connectors on the rear of the Base Station
- For DB 9F pinouts, see [Appendix A: Pinouts on page 147](#).

11.8.1 Examples of GPIs

On an input from an external device, an audio route can be established between two entities.

- If an on-air light comes on, the program feed (**PGM**) can be routed to a Channel or beltpack.
- Use a footswitch to allow the station user to open an audio route to a Channel.
- On an input from a two-way radio, an audio route can be established to a channel (the radio talks to the channel).

11.8.2 Examples of GPOs

GPOs are triggered (sent to an external device) when a **Talk**, **Talk & Listen** or a **Call** comes into a named entity.

- When someone talks to stage announce, an output relay (GPO) is sent to the external stage announce speaker.
- When someone talks to a channel labeled Radio, an output is sent to a 2-way radio.
- When a call signal (**Call**) comes into a channel, and output is sent to turn on an on-air light.

11.8.3 Examples of Logic Events

- An output can be triggered on a crosspoint activation (when someone presses a talk key).
- An input can be used to trigger a call signal.



11.8.4 Configuring GPIs

This example opens a talk route from the Base Station to a Channel when an input occurs on GPI1 (for instance, from a footswitch).

Navigate to **Configuration > Logic**.

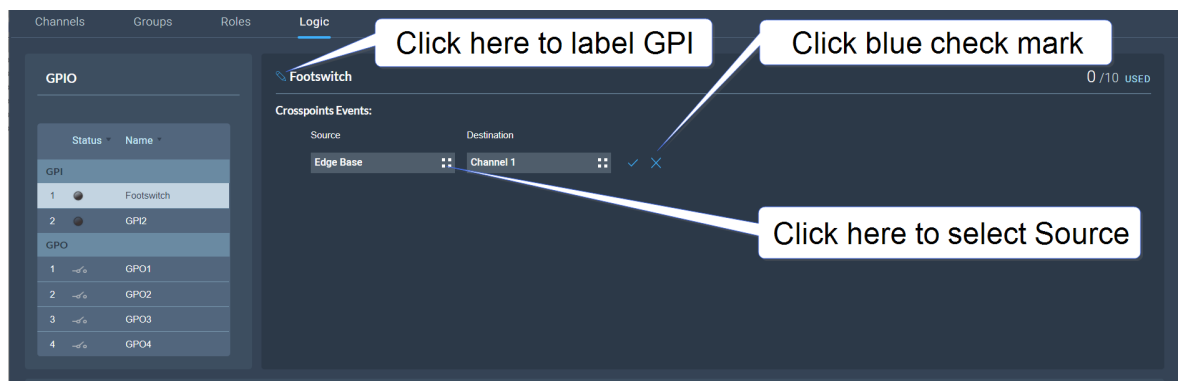
1. On the left panel, click GPI1 to select it.



2. Click the Add button  in the center panel.
3. Click the Options button  to select a **Source**. Select **Edge Base**.
4. Click the Options button  to select a **Destination**. Select the required Channel.
5. Click the blue check mark.
6. To label the GPI, click the pencil icon.
7. To test the GPI, or turn it on and off, navigate to **Status > Logic**. See: [Logic Page on page 39](#).

11.8.5 Configuring GPOs

In this example you send an output trigger (for example to an external stage announce speaker) on GPO1 when a beltPackTalk is activated on the stage announce (SA) 4-wire port.

1. Navigate to **Configuration > Logic**.



2. On the left panel, click GPO1 to select it.

3. Click the Add button  in the center panel.

4. Click the Options button  to select a **Key Target**. Select stage announce (SA).

5. In this case, the **On Behavior** field defaults to **Talk Only**.

6. Click the blue check mark.

7. To label the GPO, click the pencil icon.

8. To test the GPO, navigate to **Status > Logic**. See [Logic Page on page 39](#).

11.9 Monitoring System Status

You can monitor your system using the following features of the CCM:

- Overview
- Event Log
- Logic

11.9.1 Overview

To see the **Overview** screen, navigate to **Status > Overview**. The following screen appears.

The screenshot displays the Clear-Com CCM Overview screen. At the top, there are navigation tabs for HARDWARE, CONFIGURATION, and STATUS. Below these are sub-tabs for Overview, Logic, and Event Log. A 'Show' section allows filtering by various components: HOSTDEVICE (1/1), PORTS (9/13), I.V. DIRECT (0/1), DANTE (0/0), TRANSCIVER (0/10), WIRELESS (0/0), WIRED (1/2), and KEYPANEL (0/1). There are also checkboxes for ONLY EXCEPTIONS and HIDE OFFLINE. A legend on the right shows status indicators: Offline (grey), Online (green), Initializing (blue), Warning (yellow), and Error (red). The main content area is divided into sections for Wireless, Wired, Keypanel, I.V. Direct, and Host Device. The Host Device section is active, showing a table with one device: ff080925, Arcadia Central Station, 3.2.83.47-0. To the right, a detailed view for device ff080925 is shown, including General info (Name, Status: Good, Uptime: 23 hours 29 minutes, Sync source: PTP), Version info (Version: 3.2.83.47-0, Hardware Version, HelixNet Version), and Dante info (Dante is not available).

The **Overview** screen consists to two sections. There is an upper section that displays a list of system icons representing the ports, transceivers and endpoints and a lower section that gives detailed information about each connected device and about the Base Station.

11.9.2 System Icons

Each icon is color-coded to give an easily accessible view of the status of each entity.

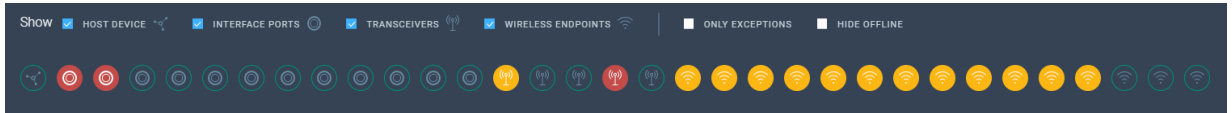

The following legend is used to indicate the status of each entity.

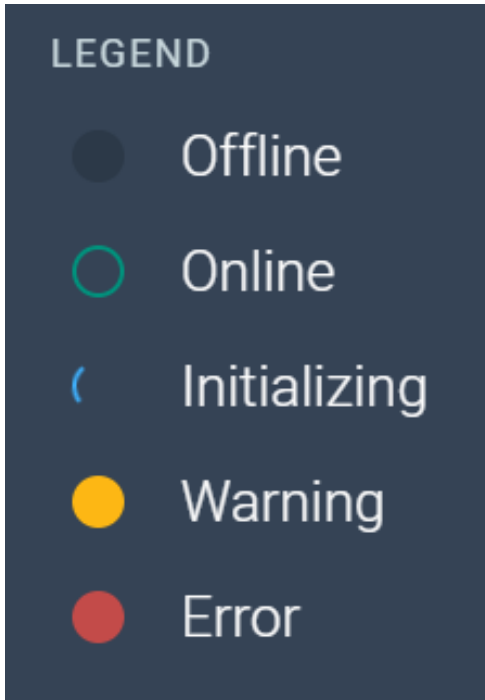

11.9.3 Monitoring Wireless Devices

Navigate to **Status > Overview > Wireless**. This section of the **Overview** screen lists all the wireless devices connected to your system, and gives the following information for each device:

- Associated role
- Type of transceiver
- Battery level
- Signal strength
- Volume setting
- Remote Microphone Kill (RMK) button to mute all microphones connected to your system
- Call button to send a text message to all connected beltacks
- Network and PTP status of transceivers

Wireless | Wired | Host Device

text to send

Device Name *	Role	Type	Battery	Signal	Keys	Vol.	RMK All	Call All	TCVR1	TCVR2	TCVR3	TCVR4	TCVR5	TCVR6	TCVR7	TCVR8	TCVR9	TCVR10	CC-TCVR-08XYF386	CC-TCVR-08XYF396	CC-TCVR-32XYI0085	CC-TCVR-32XYI0478	CC-TCVR-32XYI0108	CC-EDGE-26XYF751	CC-EDGE-07304803
EDGE-BP-524403	Producer	FSE 5.0					RMK	Call	0/4	0/4	0/4	0/0	0/0	2/4	0/4	0/4	0/0	0/0	0/10	0/0	0/10	1/10	2/10	2/10	0/10
EDGE-BP-524481	Actor	FSE 5.0					RMK	Call																	
FSII-BP-16210	Ademola	FSII 1.9					RMK	Call																	
FSII-BP-16226	Lara	FSII 1.9					RMK	Call																	
FSII-BP-28036	Katly	FSII 1.9					RMK	Call																	
FSII-BP-327796	Dancer	FSII 2.4					RMK	Call																	
FSII-BP-327814	Singer	FSII 2.4					RMK	Call																	

Transceiver details

Hardware | Configuration | Status | Clear-Com | Save | Restore | Help

Overview | Event Log | Logic

Show HOST DEVICE (1/1) PHYSICAL PORTS (9/12) DANTE PORTS (0/8) TRANSCEIVERS (2/12) WIRELESS ENDPOINTS (4/4) ONLY EXCEPTIONS HIDE OFFLINE

LEGEND >

Wireless | Wired | Host Device

text to send

Device Name *	Role	Type	Battery	Signal	Keys	Vol.	RMK All	Call All	TCVR1	TCVR2	TCVR3	TCVR4	TCVR5	TCVR6	TCVR7	TCVR8	TCVR9	TCVR10	CC-EDGE-3726934	CC-TCVR-08XYF426
EDGE-BP-524291	EDGE 1	FSE 5.0					RMK	Call	0/0	0/0	0/0	0/0	0/0	0/0	0/0	0/0	0/0	0/0	2/10	
EDGE-BP-524338	EDGE 2	FSE 5.0					RMK	Call												
FSII-BP-15901	FSBP 2	FSII 1.9					RMK	Call												
FSII-BP-16231	FSBP 1	FSII 1.9					RMK	Call												

View details

Select a transceiver to see network, version and PTP details.

PTP details

CC-TCVR-08XYF426

Network

AES67 Admin IP 169.254.8.123
Address

AES67 Audio IP 169.254.8.128
Address

Subnet Mask 255.255.0.0
Network Mode DHCP

Version

Version 4.8.67.0
Radio Version 0107
FPGA Version v.0.6.2-846;v2.3.4-b100-c2

PTP

Status Locked
Role Slave
Master ID 00-0e-98-ff-fe-08-02-3a
(Priority 127)
Local ID 00-0e-98-ff-fe-02-fe-77
(Priority 254)
Offset from Master 20 ns (max 47 ns)
Mean Path Delay 6,600 ns +/- 3
Mean Frequency -1 ppb +/- 27

Maintenance

Monitoring Beltpack Details

Select a beltpack to see details including battery type, signal strength (RSSI) and Frame Error Rate (FER).

Device Name	Role	Type	Battery	Signal	Keys	Vol	RAK AI	Call AI	TOV1	TOV2	TOV3	TOV4	TOV5	TOV6	TOV7	TOV8
EDGE-BP-524403	Producer	FSB 5.0														
EDGE-BP-524411	Actor	FSB 5.0														
FSB-BP-15210	Ademote	FSB 1.0														
FSB-BP-15226	Lava	FSB 1.0														
FSB-BP-28236	Kelly	FSB 1.0														
FSB-BP-327396	Dancer	FSB 2.4														
FSB-BP-327314	Singer	FSB 2.4														

Signal strength

EDGE-BP-524403
 Device Status: Online
 Volume: A B C D M 1 2 3 4
 Key:

General
 Model: FSB
 Frequency Type: 5.0 GHz
 Role: Producer
 ID: 080073

Version
 Version: 4.8.79.0

Battery
 Battery Type: Li-Ion
 Battery Level: 11:52 (91%)

Wireless
 Transceiver ID: 16
 Transceiver Label: CC-EDGE-26YV751
 Frame Error Rate 1: 0 %
 Frame Error Rate 2: 0 %
 RSSI 1: 90 %
 RSSI 2: 73 %

11.9.4 Monitoring the Host Device

Clear-Com | SAVE RESTORE HELP

Overview Logic Event Log

Show: HOSTDEVICE 1/1 | PORTS 9/13 | I.V. DIRECT 0/1 | DANTE 0/0 | TRANSCIVER 0/10 | WIRELESS 0/0 | WIRED 1/2 | KEYPANAL 0/1 | ONLY EXCEPTIONS | HIDE OFFLINE

Legend: Offline (grey), Online (green), Initializing (blue), Warning (yellow), Error (red)

Wireless Wired Keypanel I.V. Direct **Host Device**

Label	Type	Version
ff080925	Arcadia Central Station	3.2.83.47-0

ff080925
 Device Network Stats Tools

General

- Name: ff080925
- Status: Good
- Uptime: 23 hours 29 minutes
- Sync source: PTP

Version

- Version: 3.2.83.47-0 (Boot: NEP-1.1.11)
- Hardware Version: 5.00-B-021422 (QSPI: v.2.1.13-clearcom) (FPGA: v.1.0.0-b118) (MIXER FPGA: 0x0103)
- HelixNet Version: 5.2.19.0

Dante

Dante is not available, neither Dante Primary nor Secondary has been assigned to one of the external LAN ports.

Caution: Support Info

In **Tools** there is an option to collect support information. When you ONLY collect support information, you are advised to clear the support file after you have downloaded it.

11.10 Monitoring the Event Log

The Event Log provides useful information about events that happen in the system.

The Event Log can be filtered on:

- Time: default is 1 month prior to the current date and time
- Exceptions (warnings and errors): default is unchecked.

Events are sorted by data. Clicking the small blue arrow changes date order:

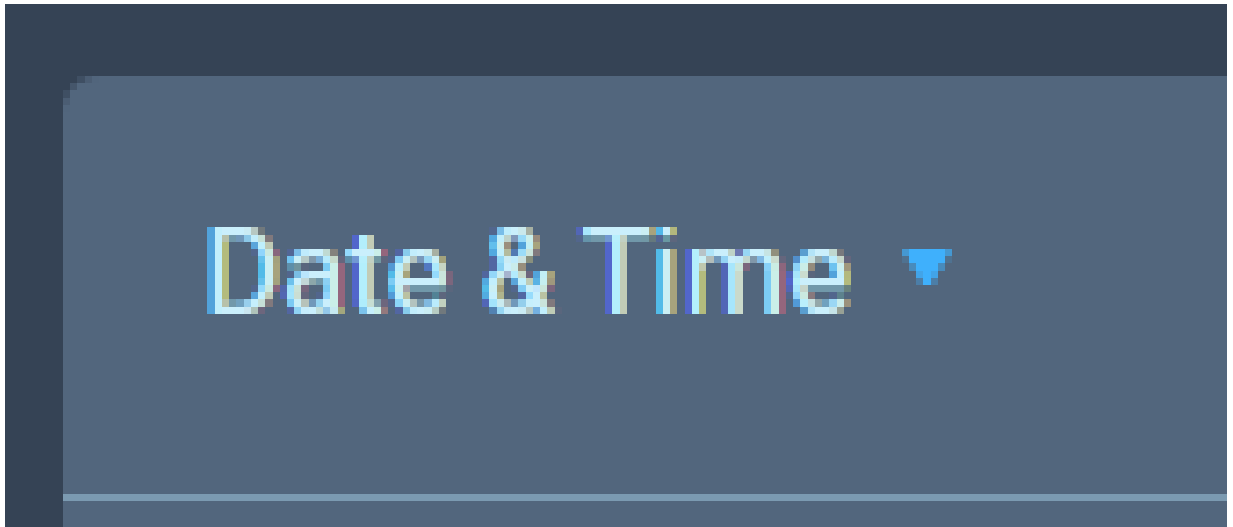

The **Level** column shows the status of data:

- Yellow triangle: warning
- Red circle with white cross: error
- No icon shown: this data is informational.

The following apply to the Event Log:

- The Event Log periodically refreshes but there is a **Refresh** button to pull the latest events
- The Event Log can be exported to a .csv file
- **Clear Event Log** clears current data. The data cannot be retrieved once it has been cleared
- Event logs are not stored permanently, only events since the last power or reboot cycle are available.

11.11 Monitoring the Logic Page

This page shows the GPIs and GPOs (relay) that you have set up in the **Configuration > Logic** page. You can see if these are currently active in the system under the **Status** column.

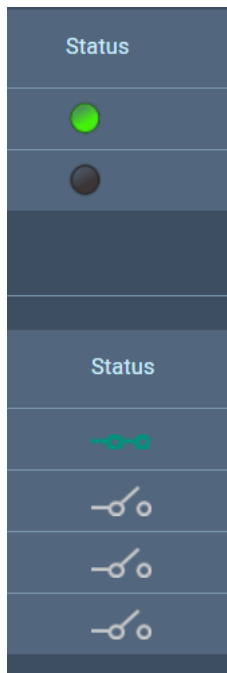

A green icon indicates a currently active input or relay.

11.11.1 Forcing ON/OFF

The buttons under the FORCE column are toggle buttons that can be used to test the working of the GPIOs or to turn them permanently off or on. These override the operation of the configured GPIOs.

Logic Inputs					
	GPI Label	Route Source	Route Destination	Status	Force
1	GPI1	No events assigned	No events assigned		<input type="button" value="OFF"/> <input type="button" value="ON"/>
2	GPI2	No events assigned	No events assigned		<input type="button" value="OFF"/> <input type="button" value="ON"/>
Logic Outputs					
	GPO Label	Key Target	On Behavior	Status	Force
1	GPO1	No triggers assigned	No triggers assigned		<input type="button" value="OFF"/> <input type="button" value="ON"/>
2	GPO2	No triggers assigned	No triggers assigned		<input type="button" value="OFF"/> <input type="button" value="ON"/>
3	GPO3	No triggers assigned	No triggers assigned		<input type="button" value="OFF"/> <input type="button" value="ON"/>

In this example, GPI 1 and GPO 2 are forced ON for testing purposes. GPO 2 is permanently OFF (for example, if you want to ensure that a signal light never comes on at this time).

12 Security

12.1 Warning

The CCM ensures that you do not turn off port 80 without testing your certificate. If you turn off port 80 without ensuring that you can reach the CCM using port 433 it is possible to get locked out of your CCM. If this happens, you must reset the Base Station from the front panel menus. This will remove all configuration, including network details from your Base Station.

Note: *Some knowledge of certificate authorization and HTTPS is needed when setting up a secure connection between a PC hosting the Core Configuration Manager (CCM) and a Base Station.*

Note: *Each browser type (for example, Safari, Chrome, Edge, Firefox) uses its own method for certificate management. These methods can change with time and is beyond the control of Clear-Com. Please refer to the instructions supplied with your browser if you require more information.*

12.2 Introduction

The following are some of the main security features.

12.2.1 Secure HyperText Transfer Protocol (HTTPS)

HTTPS is an adaptation of the HTTP protocol. It protects against an intermediary being able to intercept data between devices, using data encryption and Public Key Cryptography to create a secured channel.

12.2.2 Using HTTPS With Your FreeSpeak Edge Base Station

When using the CCM to establish your intercom setup, you might wish to protect your login credentials and configuration details from unauthorized interference. In this case you will establish an encrypted connection between the CCM and your Base Station using the **Force HTTPS** feature.

12.2.3 The Force HTTPS Feature

The Base Station uses port 80 (HTTP) and port 433 (HTTPS) for management. If you wish to create a secured route for data between the CCM and the Base Station you must:

- Install a security certificate
- Turn off port 80, forcing traffic to use port 433

This creates a certified and encrypted connection between the Base Station and the PC accessing the CCM.

12.3 Forcing HTTPS

1. Chose and install a security certificate on the PC or browser used to reach the CCM of the Base Station. Clear-Com offers a choice of 3 different types of certificate, offering different levels of security.
2. Test the certificate by trying to reach the CCM on the HTTPS port. Type: **HTTPS:// device IP address** in the browser URL field and press the [Enter] key.

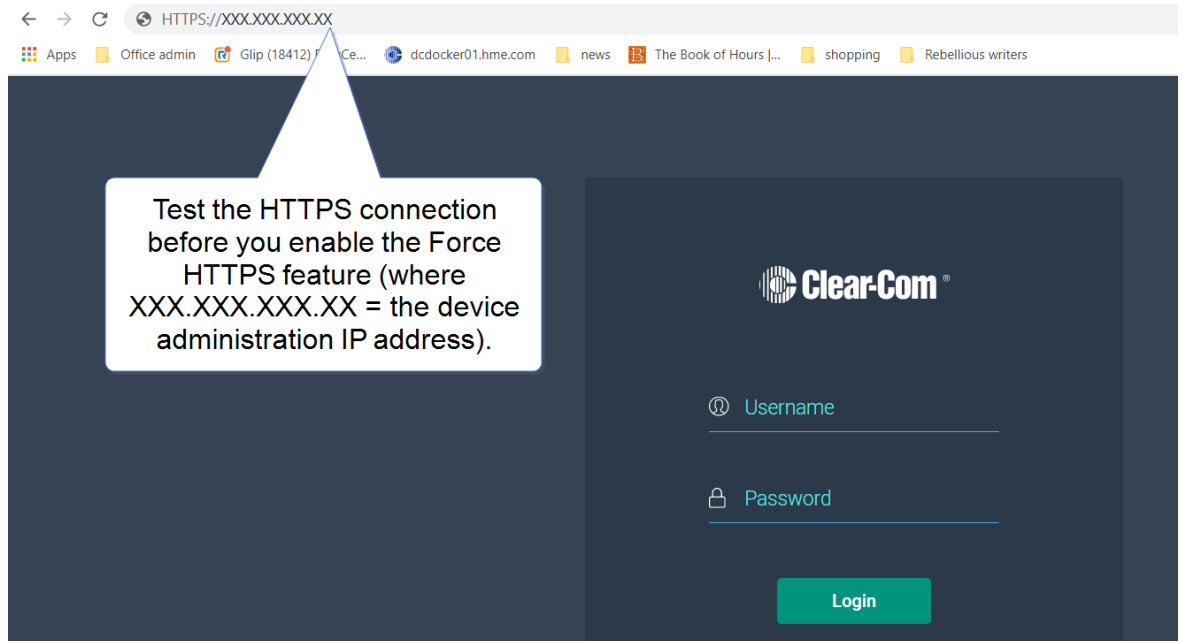

3. To enable **Force HTTPS** in the CCM navigate to: **Hardware > Resources > Host  > Security** and click to enable **Force HTTPS**. This turns port 80 off, forcing traffic to use port 433.

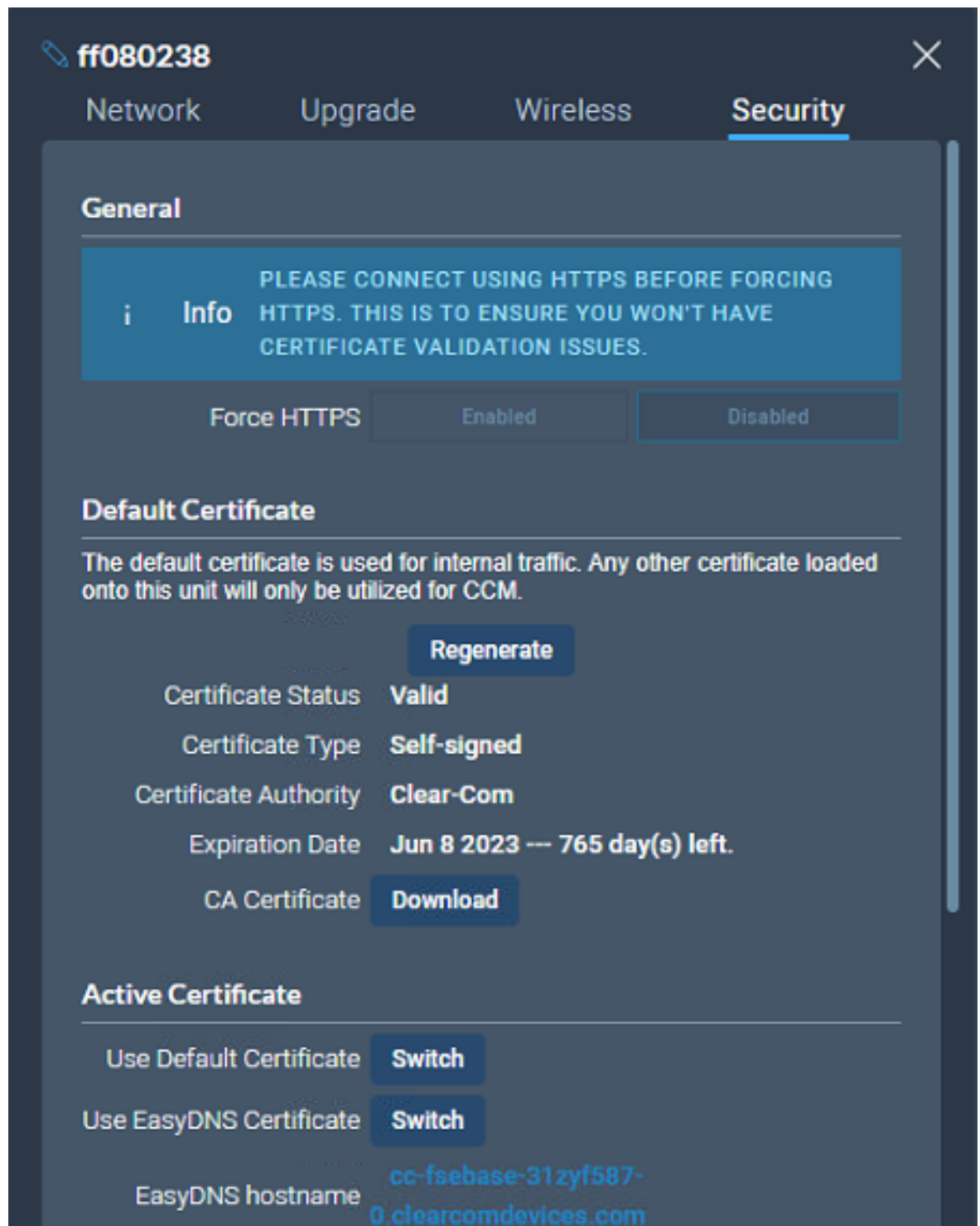

ff080238 ×

Network Upgrade Wireless **Security**

General

Info PLEASE CONNECT USING HTTPS BEFORE FORCING HTTPS. THIS IS TO ENSURE YOU WON'T HAVE CERTIFICATE VALIDATION ISSUES.

Force HTTPS Enabled Disabled

Default Certificate

The default certificate is used for internal traffic. Any other certificate loaded onto this unit will only be utilized for CCM.

[Regenerate](#)

Certificate Status	Valid
Certificate Type	Self-signed
Certificate Authority	Clear-Com
Expiration Date	Jun 8 2023 --- 765 day(s) left.
CA Certificate	Download

Active Certificate

Use Default Certificate	<input checked="" type="checkbox"/> Switch
Use EasyDNS Certificate	<input type="checkbox"/> Switch
EasyDNS hostname	cc-fsebase-31zyf587-0.clearcomdevices.com

12.4 Using Security Certificates

There are three types of security certificate available. Choose the certification option that best suits your security requirements:

- A certificate of your own choosing (full chain and private key)
- An EasyDNS authorized certificate for *.clearcomdevices.com (this option requires you to register your Base Station with a DNS server) and cannot be used unless your Base Station has internet access
- The Clear-Com self-signed certificate

More detail about certificates:

1. **A certificate of your own choosing.** This option gives you complete control over the security of your Base Station. This option requires specialized knowledge about how to obtain a fullchain certificate and private key, and how to install them on your browser. When using your own certificate you might have to provide a DNS server address and register the Base Station.
2. **The EasyDNS certificate.** This is a commercial certificate. When using the EasyDNS certificate you have to have a DNS server address for Base Station registration and a gateway for your device in order for the browser to verify the certificate with AlphaSSL and GlobalSign.
3. **The Clear-Com self-signed certificate (default).** This certificate can be used in a private network (does not require Internet access to verify the certificate). It can also be used to perform an initial test of your security setup. **Warning:** Browsers can be configured to trust the self-signed certificate, but this process will vary between browsers.

12.5 EasyDNS update button (Edge Base 4.1 and above)

The Easy DNS certificate expires every 12 months. Use the **Update Certificate** button to download and install the latest certificate from Skyport. This requires an internet connection

Find the update button in: **Hardware > Host > Security > Update Certificate.**

Note: *The certificate will not download if the Arcadia clock is wrong. Therefore, you are advised to sync the clock before downloading the certificate (**Status > Host Device > Tools > Sync Clock**).*

13 Upgrading Firmware

There are two ways to upgrade the firmware on the Base Station:

- Using the CCM web interface. When upgrading from the CCM, you can upgrade all connected resources (for example, transceivers and beltpacks).
- Using a USB stick (USB A on the front of the Base Station). When upgrading in this way, only the Base Station can be upgraded.

Device to upgrade	File extension
Base Station, FS II IP TCVR, FS Edge IP TCVR	.ccf
FS II beltpack, FS II E1 TCVR	.fww
FS Edge beltpack	.ccu

Note: *The FreeSpeak Edge Base Station validates firmware versions to internal hardware. In some instances, the FreeSpeak Edge Base Station and its components cannot be downgraded. In these instances use a newer firmware version.*

Note: *Over the Air (OTA) upgrade is not available for the FreeSpeak Icon beltpack. FreeSpeak Icon beltpacks are upgraded over USB connection using a separate utility.*

13.1 Upgrading using the CCM

1. In the CCM, navigate to **Hardware > Hosts (click anywhere on the Hosts panel) > Upgrade**.
2. Press **Select File** and select the file containing the updated firmware.
3. When the file is uploaded, the **Upgrade** button will be enabled.
4. Press the **Upgrade** button.
5. The upgrade process will start and the Base Station will reboot before being available again.
6. The new version of the firmware will be displayed in the **Hosts** panel.

13.2 Upgrading using a USB stick

1. Copy the firmware file onto a USB stick. The file must be at the top level of the USB drive, not within any folders.
2. Insert the USB into the USB port on the front of the Base Station.

3. Press the **Menu** button.
4. Using the rotary controllers, navigate to **Administration > Software > Update**.
5. The display will show the available firmware files stored on the USB. Select the one you require.
6. Press the 4th rotary encoder. The unit will upgrade and then reboot.
7. To check the current firmware version, in the menu system navigate to **Administration > Software > Current**. The current software version is displayed in the 4th menu screen.

14

Spare parts

Part	Part Number
External power supply, 12VDC 150W	PSU-EXT-0001
Split cable, RJ45 to PGM and SA	CAB-RJ45-PGM-SA
Ethernet fiber modules*: <ul style="list-style-type: none"> • 1 Gbps SM SXFIBER SFP • 1 Gbps MM LXFIBER SFP 	<ul style="list-style-type: none"> • SFP-SMFO-1G-LX • SFP-MMFO-1G-SX
E1 fiber modules* <ul style="list-style-type: none"> • Proprietary, based on E1: SM • Proprietary, based on E1: MM 	<ul style="list-style-type: none"> • HLI-SMFO • HLI-MMFO
Fan plate assembly	T40020-1
Rack ear (x1)	272G162
PSU Mounting Bracket	272G048
Encoder cap (x1)	272G286
FreeSpeak Edge Base Station User Guide	PUB-00113

*There is a detailed list of all Clear-Com SFPs (including range, wavelength and speed) on the [FreeSpeak II Knowledge Center](#).

15 Front Panel Menu Reference Tables

This chapter lists the front panel menu options. It contains the following sections:

15.1 Audio Settings	141
15.2 Host Settings	141
15.3 2 W Audio (A/B) (C/D)	142
15.4 Discovery	142
15.5 Transceiver	143
15.6 Networking	144
15.7 Administration	145

Note: Default values are shown in **bold**.

15.1 Audio Settings

Level 1	Level 2	Level 3	Level 4
Audio	Headset	Headset Limit	8 to -12 dB/Off Default = 0 dB
		Headset detect	Enabled /Disabled
		HS Mic Type	Electret/ Dynamic
		Sidetone Gain	8 to -15 dB Default = -12
		Sidetone Control	Tracking /Non-Tracking/Disabled

15.2 Host Settings

Level 1	Level 2	Level 3	Level 4
Host Settings	Host name	Edit	Press controller 4 to open a touchscreen keyboard.
	Display	Screen Brightness	High/ Medium /Low/Very Low
		Screen Dimming	1 to 15 minutes Default = 2 minutes
		Touchscreen sensitivity	Low, Medium , High

15.3 2 W Audio (A/B) (C/D)

Level 1	Level 2	Level 3	Level 4
2W Audio (A / B)	Interface	Power detected	Yes/No
		Power	Enabled/ Disabled
		Mode	Clear-Com /RTS
	2W A	Nulling	The nulling function is only available if power is detected.
	2W B	Nulling	as above
Audio (B / C)	Same as Audio (A / B)		

15.4 Discovery

Level 1	Level 2	Level 3	Level 4
Discovery	Discover FSII IP TCVR	Discovered FSII IP TCVRs	Register/Unregister
	Discover FSE TCVR	Discovered FSE TCVRs	Register/Unregister

15.5 Transceiver

Level 1	Level 2	Level 3	Level 4
Transceiver	TCVR 1 ... XX View configured transceivers. Max: <ul style="list-style-type: none"> • E1; 10 • IP TCVRs; 6 	Version	
		Label	
		Cable Comp (E1 only)	0 - 69 m , 70 - 139 m, 140 - 209 m, 210 - 279 m, 280 - 349 m, ... (increments of 70 m) up to 1540 - 1609 m

15.6 Networking

Level 1	Level 2	Level 3	Level 4
Networking	Management	LAN Status	Up/Down
		LAN Port	LAN Ports 1 - 4
		DHCP	Enabled/Disabled
		IP Address	
		Subnet mask	
		MAC	
	AES67 (only visible if AES67 has been configured to its own LAN)	LAN Status	Up/Down
	Dante (only visible if Dante has been configured in the CCM)		
		LAN Port	By default management is configured to LAN 1. This can be changed in the CCM. AES67 is configured to LAN 2.
		DHCP	Enabled/Disabled
		IP Address	
		Subnet mask	
		MAC	MAC address

15.7 Administration

Level 1	Level 2	Level 3	Level 4
Administration	Beltpacks	Over The Air	Start OTA
		BP Role List Sorting	Sort by Role Number /Alphabetical Alkaline /NiMh (for use when not using the supplied Li-ion type batteries)
		Battery Type	View current version Use this to update the Base Station using a USB stick.
	Software	Current	Press rotary 4 to reboot now
		Update	Reset Base. When you reset the Base here, as well as system setup details (channels and roles), network details (IP addresses) are also reset. This is not the case when resetting the Base in the CCM. After resetting you must Add transceivers again.
	Reset	Reboot	Press rotary 4 to reset CCM password to the default setting.
		Reset to Default	Insert USB
		Reset CCM Password	Insert USB
	Support Info	Generate	
		Save	
	Settings	Restore	

Level 1	Level 2	Level 3	Level 4
	CCM Access	Username	
		Default password	
		Hw Info	
		Hw Version	
	Hardware	BOM number	
		PCB number	
		Serial number	
		Product number	

16 Appendix A: Pinouts

16.1 GPIO pinouts

GPIO 1 (Relay 1 &2)

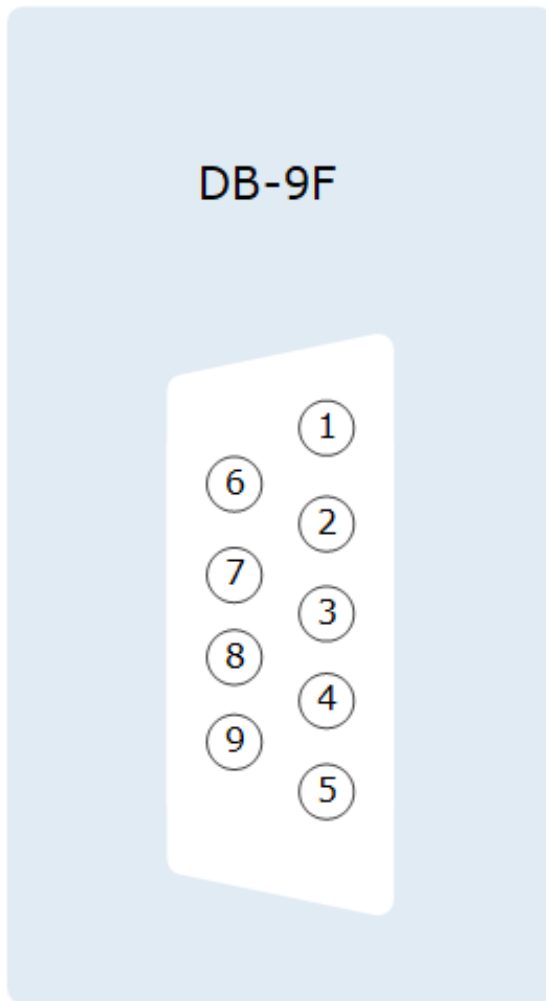

1. Relay 1 Common
2. Relay 1 Normally Closed
3. Relay 1 Normally open
6. Relay 2 Common
7. Relay 2 Normally Closed
8. Relay 2 Normally Open
4. Input A1
5. Input B1
9. 12V

Shield 0V

GPIO 2 (Relay 3 & 4)



1. Relay 3 Common
2. Relay 3 Normally Closed
3. Relay 3 Normally open
6. Relay 4 Common
7. Relay 4 Normally Closed
8. Relay 4 Normally Open
4. Input A2
5. Input B2
9. 12V

Shield 0V

Suggested wiring for a footswitch

From	To	
GPIO-DB9 pin 4 (input A1)	GPIO-DB9 pin 9 (+12V)	Connects power to GPI A-Side
GPIO-DB9 pin 5 (input B1)	Switch	Connects power to GPI B-Side when engaged
GPIO-DB9 Shell (0V)	Switch	

16.2 2-Wire Pinouts

16.2.1 Clear-Com 2-Wire XLR Pinout

1. Ground
2. DC power (30V)
3. Duplex audio

XLR3F

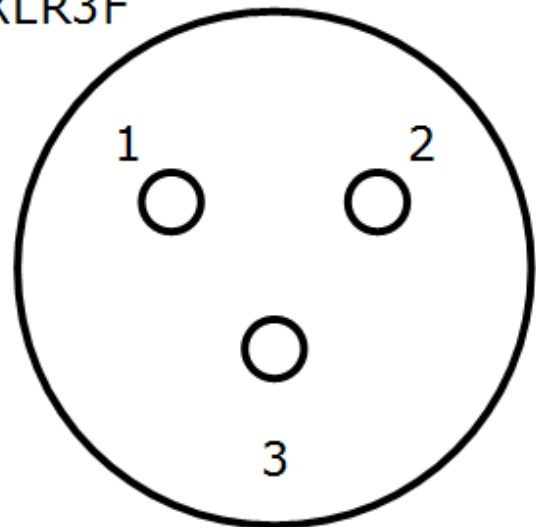

16.2.2 RTS/TW 2-Wire XLR pinout

1. Ground
2. DC power (30V)
Duplex audio 1
3. Duplex audio 2

XLR3F

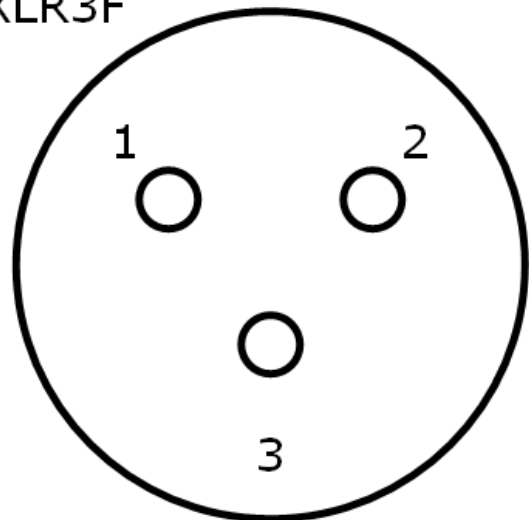

16.3 4-Wire Pinouts

Pin	4-wire	4-wire-X (default)
1	Data in +	Data out +
2	Data in -	Data out -
3	Audio in +	Audio out +
4	Audio out +	Audio in +
5	Audio out -	Audio in -
6	Audio in -	Audio out -
7	Data out +	Data in +
8	Data out -	Data in -

16.4 DECT Sync

Pin	Sync In	Sync Out
Pin 1	DECTSYNC IN +	DECTSYNC OUT +
Pin 2	DECTSYNC IN -	DECTSYNC OUT -
Pin 3	8 KHZ IN +	8 KHZ OUT +
Pin 6	8 KHZ IN -	8 KHZ OUT -

Caution: Shielded Cable Requirement

Shielded Cable is required for ALL FreeSpeak and GPIO port connectivity. CAT 5e Shielded Cable must be used to assure compliance with domestic and international emissions standards. Customers, Installers and or qualified Personnel failing to use shielded cables may cause radio interference in which case the user may be required to take adequate measures.

Appendix C: Specifications

This chapter contains a list of technical specifications for the Station. It contains the following subsections:

17.1 FreeSpeak Edge Base Station	152
17.2 Capacity	155
17.3 Network Specifications	156

17.1 FreeSpeak Edge Base Station

Specification	Value
Front panel headset	(1) 4-pin XLR-M <ul style="list-style-type: none"> • auto headset detect
Front panel headset microphone input	<ul style="list-style-type: none"> • Input type: Dynamic /Electret - Selectable • Frequency response: headset mic - Partyline: 200Hz – 12 kHz + 3dBu • Frequency response: headset mic - Line Out: 200Hz – 20 kHz + 3dBu • Mic limiter threshold: -50dBu ±3dB • Mic limiter range: ≥ 20dB • Max input level: -25dBu • Input level: -60dBu nominal; -25dBu MAX • Headset mic voltage 5V (Electret selectable)
Front panel headset microphone output	<ul style="list-style-type: none"> • Load Impedance: > 32Ω • Output Impedance: 33Ω • Max Output Level before Distortion: >13 dBu • Total Harmonic Distortion (THD): < 0.1% THD at 1 kHz • Headset Mic - Partyline: -78 dBu (Clear-Com mode) • Headset Mic - Line Out: -60 dBu • Frequency Response: Partyline - Headset Out: 200Hz – 10 kHz + 3dBu
USB connector	USB type A
Front panel buttons	<ul style="list-style-type: none"> • MIC: Microphone ON/OFF button • Menu button
Front panel rotary encoders	(5) Digital rotary encoders Operating level: 0dBu to + 18dBu, nominal, or -18dBu to +8dBu

Specification	Value
Front panel touch screens	(2) 480 x 128 color TFT LED Touch Screen displays
Status LEDs	(2) Power supply status LEDs, (1) Base Station speaker LED, (1) Volume level three color control LED array
The Base Station has two power supplies which can be used together to provide power redundancy.	
Power	<ol style="list-style-type: none"> 1. AC Mains input: 100-240V AC, 50-60Hz, 160W Max, IEC60320 C14 inlet. 2. DC Low Voltage Input: 12V DC +/- 5%, 12A
GPIO port	<p>(2) DB9F</p> <ul style="list-style-type: none"> • Relay contact type: SPDT • Relay quantity: 4 • Relay contact voltage rating: 30 VDC • Relay contact current rating: 1 A • Input type: Opto-Isolated • Input quantity: 2 • Input voltage range: 4 - 30 volts DC or AC • Input current: >=1.2mA required

Specification	Value
2-wire I/O	<p>(4) XLR-3F</p> <ul style="list-style-type: none"> • 2-wire I/O: Selectable RTS or Clear-Com mode, software controlled null, null depth >60dB at 1kHz • 2-wire Power On/Off: A/B, C/D paired- software controlled • 2-wire Output Voltage: 25 – 28 VDC, 560 mA per pair (A/B or C/D) • 2-wire Impedance: >10kΩ • 2-wire Operating Levels: -18dBu nominal (Clear-Com Mode), -12dBu nominal (RTS Mode), Headroom 18dB • 2-wire Frequency Response: 200 to 12kHz. ±3dB • 2-wire Total Harmonic Distortion (THD): < 0.1% THD at 1 kHz
4-wire I/O	<p>(8) RJ45</p> <ul style="list-style-type: none"> • 4-wire I/O: Output Impedance >10kΩ, Input Impedance 200Ω + 10%, transformer isolated balanced input and output. • 4-wire Operating Levels: 0dBu Nominal, 18dBu headroom • Port 8 used for stage announce and program feed
Stage announce and program feed	<p>(1) Cable assembly CAB-RJ45-PGM-SA provided. Connects to RJ45 (port 8 on the Station)</p> <ul style="list-style-type: none"> • XLR-3F labeled PGM input • XLR-3M labeled SA output <p>Program Input level control via rotary encoder.</p>
DECT Sync IN/OUT	(2) RJ45 sync input and output
E1 Splitter/transceiver ports	<p>(2) RJ45 (2) Fiber, to be used with SFP module</p> <p>Note: 2 splitter ports are active at any one time</p>

Specification	Value
LAN connectors	(2) RJ45 (2) SFP, to be used with Fiber or RJ45 SFP module All 4 LAN ports are fully user configurable, to be split between management, AES67 and Dante traffic.
Dimensions	1 RU: h.44 x w.483 x d. 355 mm (1.75 x 19 x 14 inches)
Weight	Approx 3.3 kg (7.25 lb)
Frequency response - station to beltpack	
Base Station to beltpack frequency response	<ul style="list-style-type: none"> FreeSpeak II & FreeSpeak Icon beltpacks: 200 Hz - 7.5 kHz FreeSpeak Edge beltpacks: 200 Hz - 12 kHz

17.2 Capacity

Specification	Value
Number of transceivers supported by Base Station	<ul style="list-style-type: none"> 6 IP transceivers (FreeSpeak II or FreeSpeak Edge) E1 transceivers, 2 connected directly to the Base Station, 10 via splitters
Number of FreeSpeak beltpacks per Base Station	Up to 16 beltpacks in total, made up of either FreeSpeak II, FreeSpeak Icon or FreeSpeak Edge beltpacks
Audio Channels	Max 100
Groups	Max 100
GPIOs	2 x GPI, 4 x GPO

17.3 Network Specifications

Specification	Value
AoIP Interface Protocols	<ul style="list-style-type: none"> • RTSP/SAP • AES67 • Dante
Audio Sampling	24-bit Linear 48KHz
IP Addressing	<ul style="list-style-type: none"> • Static • DHCP
Network Compatibility	Layer 2 - Non-Routable
Quality of Service	DiffServ RFC2474
IGMP	On (AoIP)
Multicast	On (AoIP)
Network Timing	PTPv2 (AoIP)/PTPv1 (Dante)
Perduplex Connection	<ul style="list-style-type: none"> • 1 x FS II IPT bandwidth usage: ~7 Mbps • 1 x FS Edge IPT: ~9.6 Mbps
Network Protocols	<ul style="list-style-type: none"> • Ethernet IPv4 Unicast Audio and Control • mDNS-Multicast Device Discovery
Network Ports	<ul style="list-style-type: none"> • Unicast: • Port 80 TCP - Web Interface, System Management, Expansion • Port 443 for HTTPS • Port 6001 UDP - AES67 Data • Port 15000 - 15256 UDP - AES67 Audio
	<p>Multicast:</p> <p>Port 5353 UDP - mDNS, Names, Discovery, Linking, Expansion, Dante (through various ports)</p>

Specification	Value	
Network Jitter Tolerance	< 1µs required for RF Syncing of Transceivers	
Recommended Ethernet Switches	<ul style="list-style-type: none"> • Managed Ethernet Switch • 1000 Base - T ports for endpoints • 1000 Base IP Trunks between switches • QoS Configuration • Energy Efficient Ethernet bypass option • IGMP Snooping bypass option 	
QoS Tags for AoIP		
Clock	IEEE 1588-2008 Announce, Synch, Follow Up, Delay_Req, Delay_Resp, Pdelay_Req, Pdelay_Resp and Pdelay_Resp_Follow_Up packets	EF (46) (Expedited Forwarding)
Media	RTP and RTCP media stream data	AF41 (34) (Assured Forwarding)
Best Effort	IEEE 1588-2008 signaling and management messages. Discovery and connection management messages.	DF (0) (Default Forwarding)
QoS Tags for Dante		
High	Time Critical PTP Events	CS7 (56)
Medium	Audio, PTP	EF (46) (Expedited Forwarding)
Low	Reserved	CS1 (8)
None	Other Traffic	Best Effort (0)

Appendix D: Spare Parts

Part	Part Number
External power supply, 12VDC 150W	PSU-EXT-0001
Split cable, RJ45 to PGM and SA	CAB-RJ45-PGM-SA
Fan plate assembly	T40020-1
Rack ear (x1)	272G162-SP
Encoder cap (x1)	272G286-SP
Optional equipment	
Ethernet fiber modules*: 1 Gbps SM SXFIBER SFP 1 Gbps MM LXFIBER SFP 1 Gbps RJ45 SFP	SFP-SMFO-1G-LX SFP-MMFO-1G-SX SFP-RJ45-1G
FreeSpeak E1 fiber modules E1 Multi-Mode E1 Single-Mode	SFP-MMFO-100M-FX or HLI-MMFO SFP-SMFO-100M-LX or HLI-SMFO
Gooseneck microphones Gooseneck Mic 250mm/9" TRS Gooseneck Mic 450mm/18" TRS	GN-250-TRS GN-450-TRS
PSU Mounting Bracket	272G048-SP

*There is a detailed list of all Clear-Com SFPs (including range, wavelength and speed) on the [Clear-Com Arcadia Knowledge Center](#).

Appendix E: Front Panel Menu Reference Tables

This chapter lists the front panel menu options. It contains the following sections:

19.1 Audio Settings	160
19.2 Host Settings	160
19.3 2 W Audio (A/B) (C/D)	161
19.4 Discovery	161
19.5 Transceiver	161
19.6 Networking	162
19.7 Administration	163

Note: Default values are shown in **bold**.

19.1 Audio Settings

Level 1	Level 2	Level 3	Level 4
Audio	Headset	Headset Limit	8 to -12 dB/Off Default = 0 dB
		Headset detect	Enabled/Disabled
		HS Mic Type	Electret/ Dynamic
		Sidetone Gain	8 to -12 dB Default = -12
		Sidetone Control	Tracking/Non-Tracking/Disabled
	Gooseneck	GN Mic Type	Electret
			Dynamic

19.2 Host Settings

Level 1	Level 2	Level 3	Level 4
Host Settings	Host name	Edit	Press controller 4 to open a touchscreen keyboard.
	Display	Screen Brightness	High/ Medium / Low/Very Low
		Screen Dimming	1 to 15 minutes Default = 2 minutes
		Touchscreen sensitivity	Low, Medium , High

19.3 2 W Audio (A/B) (C/D)

Level 1	Level 2	Level 3	Level 4
2W Audio (A / B)	Interface	Power detected	Yes/No
		Power	Enabled/ Disabled
		Mode	Clear-Com /RTS
	2W A	Nulling	The nulling function is only available if power is detected.
	2W B	Nulling	as above
Audio (B / C)	Same as Audio (A / B)		

19.4 Discovery

Level 1	Level 2	Level 3	Level 4
Discovery	Discover FSII IP TCVR	Discovered FSII IP TCVRs	Register/Unregister
	Discover FSE TCVR	Discovered FSE TCVRs	Register/Unregister

19.5 Transceiver

Level 1	Level 2	Level 3	Level 4
Transceiver	TCVR 1 ... XX View configured transceivers.	Version	
		Label	
		Cable Comp (E1 only)	0 - 69 m , 70 - 139 m, 140 - 209 m, 210 - 279 m, 280 - 349 m, ... (increments of 70 m) up to 1540 - 1609 m

19.6 Networking

Level 1	Level 2	Level 3	Level 4
Networking	Management	LAN Status	Up/Down
		LAN Port	LAN Ports 1 - 4
		DHCP	Enabled/Disabled
		IP Address	
		Subnet mask	
		MAC	
	AES67 (only visible if AES67 has been configured to its own LAN)	LAN Status	Up/Down
	Dante (only visible if Dante has been configured in the CCM)		
		LAN Port	By default Management is configured to LAN 1. AES67 is configured to LAN 2. This can be changed in the CCM.
		DHCP	Enabled/Disabled
		IP Address	
		Subnet mask	
		MAC	MAC address

19.7 Administration

Level 1	Level 2	Level 3	Level 4
Administration	Beltpacks	Over The Air	Start OTA
		BP Role List Sorting	Sort by Role Number /Alphabetical
		Battery Type	Alkaline /NiMh (for use when not using the supplied Li-ion type batteries)
	Software	Current	View current version
		Update	Use this to update the Base Station using a USB stick.
	Reset	Reboot	Press rotary 4 to reboot now
		Reset to Default	Reset Base. When you reset the Base here, as well as system setup details (channels and roles), network details (IP addresses) are also reset. This is not the case when resetting the Base in the CCM. After resetting you must Add transceivers again.
		Reset CCM Password	Press rotary 4 to reset CCM password to the default setting.

Level 1	Level 2	Level 3	Level 4
	Support Info	Generate	Insert USB
	Settings	Save Restore	Insert USB
	CCM Access	Username Default password	
	Hardware	Hw Info Hw Version BOM number PCB number Serial number Product number	Read only. Serial number here is the number of the electronic main board, not the Arcadia device.

20 Regulatory Compliance (Regulatory Model: 1410)

Applicant Name: Clear-Com LLC

Applicant Address: 1301 Marina Village Pkwy, Suite 105, Alameda CA 94501, United States

Manufacturer Name: Clear-Com LLC

Manufacturer Address: 1301 Marina Village Pkwy, Suite 105, Alameda CA 94501, United States

Country of Origin: USA

Brand: Clear-Com

Caution: All products are compliant with regulatory requirements detailed in this document when the user follows all installation instructions and operating conditions per Clear-Com specifications

Caution: Use of accessories and peripherals other than those recommended by Clear-Com may void the product's compliance as well as the user's authority to operate the equipment.

20.1 FCC Notice

This device complies with Part 15 of the FCC rules. Operation is subject to the following two conditions: (1) This device may not cause harmful interference, and (2) This device must accept any interference received, including interference that may cause undesired operation.

NOTE: This equipment has been tested and found to comply with the limits for a Class A digital device, pursuant to Part 15 of the FCC rules. These limits are designed to provide reasonable protection against harmful interference when the equipment is operated in a commercial environment. This equipment generates, uses and can radiate radio frequency energy and, if not installed and used in accordance with the instruction manual, may cause harmful interference to radio communication. Operation of this equipment in a residential area is likely to cause harmful interference, in which case the user will be required to correct the interference at his own expense.

Changes or modifications not expressly approved by Clear-Com, LLC, an HM Electronics, Inc. company could void the user's authority to operate this equipment.

20.2 FCC/IC/EC RF Exposure Warning

- This product complies with FCC/IC/EC radiation exposure limits set forth for an uncontrolled environment.
- Produits Clear-Com sont conformes aux limites IC d'exposition aux rayonnements définies pour un environnement non contrôlé.
- This product may not be co-located or operated in conjunction with any other transceiver or transmitter.
- Ce produit ne peut pas être co-localisé ou utilisé en conjonction avec un autre émetteur-récepteur ou émetteur.
- To comply with FCC/IC/EC RF exposure requirements, the Antenna/Transceiver unit must be installed and operated at least 20 cm (8 inches) from any person.
- Produits Clear-Com doivent être installés et utilisés avec distance minimum de 20cm entre le radiateur et votre corps.

20.3 Industry Canada Compliance Statement

This Class[A] digital device complies with Canadian ICES-003.

Avis de conformité à la réglementation d'Industrie Canada

Cet appareil est conforme aux CNR d'Industrie Canada applicables aux appareils radio exempts de licence. L'exploitation est soumise aux deux conditions suivantes:

(1) cet appareil ne doit pas provoquer d'interférence, et

(2) cet appareil doit accepter toute interférence radioélectrique subie, même si l'interférence est susceptible d'en compromettre le fonctionnement.

Cet émetteur exempt de licence est équipé d'une antenne intégrée. Cet émetteur exempt de licence n'est pas autorisé à fonctionner avec une autre antenne.

Cet appareil numérique de la class[*] est conforme à la norme NMB-003 du Canada.

20.4 Korean Notice

A급 기기 (업무용 방송통신기자재)

이 기기는 업무용(A급)으로 전자파적합기기로서 판매자 또는 사용자는 이 점을 주의하시기 바라며, 가정외의 지역에서 사용하는 것을 목적으로 합니다.

20.5 European Union (CE mark)

The CE marking indicates compliance with the following directives and standards, whenever applicable to the product in question.

Directives:

- Radio Equipment Directive 2014/53/EU
- Electromagnetic Compatibility Directive 2014/30/EU
- Low Voltage Directive 2014/35/EU
- RoHS Directive 2011/65/EU, 2015/863/EU

Standards:

- EN55032
- EN55035
- IEC/EN62368-1
- EN300328
- EN301489
- EN50581



20.6 United Kingdom (UKCA Mark)

The UKCA (UK Conformity Assessed) marking is a new UK product marking that will be used for goods being placed on the market in Great Britain (England, Wales and Scotland). The UKCA marking alone cannot be used for goods placed on the Northern Ireland market, which require the CE marking or UK(NI) marking.



Warning:

This is a Class A product. In a domestic environment this product may cause radio interference in which case the user may be required to take adequate measures.

20.7 Electrical and Electronic Equipment (WEEE) Waste

The European Union (EU) WEEE Directive (2012/19/EU) places an obligation on producers (manufacturers, distributors and/or retailers) to take-back electronic products at the end of their useful life. The WEEE Directive covers most Clear-Com products being sold into the EU as of August 13, 2005. Manufacturers, distributors and retailers are obliged to finance the costs of recovery from municipal collection points, reuse, and recycling of specified percentages per the WEEE requirements.

Instructions for Disposal of WEEE by Users in the European Union

The symbol shown below is on the product or on its packaging which indicates that this product was put on the market after August 13, 2005 and must not be disposed of with other waste. Instead, it is the user's responsibility to dispose of the user's waste equipment by handing it over to a designated collection point for the recycling of WEEE. The separate collection and recycling of waste equipment at the time of disposal will help to conserve natural resources and ensure that it is recycled in a manner that protects human health and the environment. For more information about where you can drop off your waste equipment for recycling, please contact your local authority, your household waste disposal service or the seller from whom you purchased the product.

