

User Guide

Eclipse 15.0 HX-Median User Guide



Part Number: PUB-00374 Rev A

Date: June 05, 2026

Document reference

Eclipse HX-Median User Guide

Part Number: PUB-00374 Rev A

Legal disclaimers

Copyright © 2026 HME Clear-Com Ltd

All rights reserved

Clear-Com and the Clear-Com logo are trademarks or registered trademarks of HM Electronics, Inc.

The software described in this document is furnished under a license agreement and may be used only in accordance with the terms of the agreement.

The product described in this document is distributed under licenses restricting its use, copying, distribution, and decompilation / reverse engineering. No part of this document may be reproduced in any form by any means without prior written authorization of Clear-Com, an HME Company.

Clear-Com Offices are located in California, USA; Cambridge, UK; Dubai, UAE; Montreal, Canada; and Beijing, China. Specific addresses and contact information can be found on Clear-Com's corporate website: www.clearcom.com.

Clear-Com contacts

Americas and Asia-Pacific Headquarters

California, United States

Tel: +1 510 337 6600

Email: SalesSupportUS@clearcom.com

Europe, Middle East, and Africa Headquarters

Cambridge, United Kingdom

Tel: +44 1223 815000

Email: SalesSupportEMEA@clearcom.com

China Office

Beijing Representative Office

Beijing, P.R. China

Tel: +8610 59000198/59002608

Email: SalesSupportChina@Clearcom.com

Table of contents

1 Important Safety Instructions	7
2 Introduction	9
2.1 Further Information	9
3 Overview	10
3.1 Eclipse HX Matrix Frames	10
3.2 Interface Modules	11
3.3 Interface Cards	11
3.4 EHX Configuration Software	15
3.5 User Panels	16
3.6 Eclipse HX-Median	16
4 Installing the Eclipse HX-Median	23
4.1 Cabling Recommendations	23
4.2 Before you Begin the Installation	23
4.3 Installing the Eclipse HX-Median	28
4.4 Installing CPU Cards	29
4.5 Installing Interface Cards	33
4.6 Wiring Audio Devices to the Matrix Frame	37
4.7 Wiring Panels to the Matrix Frame	38
4.8 Wiring CPU Card Interfaces	40
4.9 E1/T1 Matrix to Matrix Straight Cable Connections	53
4.10 E1 to FreeSpeak II Antenna Straight Cable Connection	54
5 Using the Eclipse HX-Median	56
5.1 Creating and Storing System Configurations	56
5.2 Setting the Default IP Address	56
5.3 Using the CPU Card Ethernet ports	57
5.4 CPU Card Fail-Safes	58
5.5 CPU Card Lights and Controls	58
5.6 MVX-A16 Analog Card Front-Panel Lights and Controls	65
5.7 Diagnosing Power Supply Problems	67
5.8 Connecting the Matrix Frame	71

5.9 Connecting 4-Wire	74
6 E-MADI64 Card	82
6.1 E-MADI64 Front Panel Lights and Controls	83
6.2 E-MADI64 Rear Panel Connectors	87
6.3 MADI Channels	88
6.4 Setting Up the E-MADI64 Card	89
6.5 V-Series Panels on E-MADI (Multi-Channel Audio Digital Interface)	91
6.6 Configuring Binaural Audio with E-MADI Cards	93
6.7 Configuring Binaural Panel Audio in Software	93
6.8 Set the EHX Audio Mixer Screen Option for Binaural Audio Routing	95
6.9 Upgrading the E-MADI64 Card	95
7 E-FIB Fiber Card	96
7.1 E-FIB Front Panel Lights and Controls	97
7.2 E-FIB Rear Panel Lights and Connectors	100
7.3 Configuring a Fiber Optic Connection	102
7.4 Simplex Fiber Cabling	103
8 E-QUE E1/T1 Card	108
8.1 E-QUE Front Panel Lights and Controls	109
8.2 E-QUE Rear Panel Connectors	111
8.3 E-QUE Interface Card Applications	113
8.4 E1 Trunk and Direct Modes	117
8.5 T1 Trunking	121
8.6 Trunking Failover	123
9 IVC-32 Card for IP-Based Connections	124
9.1 IVC-32 Front Panel Lights and Controls	125
9.2 IVC-32 Rear Panel Connectors	127
9.3 IVC-32 Interface Applications	128
10 LMC-64 Metering Card	130
10.1 LMC-64 Front Panel Lights and Controls	131
10.2 LMC-64 Rear Panel Connectors	133
10.3 LMC-64 Interface Applications	134

11 E-DANTE64-HX Card	136
11.1 Example Applications	137
11.2 Using the E-DANTE64-HX Card	138
11.3 E-DANTE64-HX Front Panel Lights and Controls	140
11.4 E-DANTE64-HX Rear Panel Lights and Controls	143
11.5 Network Configuration	145
11.6 Installing a Replacement or Backup Card	145
11.7 Upgrading your E-DANTE64-HX Card	146
11.8 Troubleshooting: Sample Rate	148
11.9 Troubleshooting: I Need to Find the E-DANTE64-HX Card's IP Address	149
12 E-IPA-HX High Capacity IP to Matrix Card	153
12.1 Adding an E-IPA-HX Card (Automatic Discovery)	154
12.2 Licenses	154
12.3 Card Capacity	156
12.4 E-IPA-HX Rear Connectors	158
12.5 E-IPA-HX Front Lens Indicators	160
13 Maintaining the Eclipse HX-Median	163
13.1 Routine Maintenance Recommendations	163
13.2 Fail-Safe Modes	164
13.3 Troubleshooting	165
13.4 System Block Diagram	169
14 Regulatory Compliance	170
14.1 United Kingdom (UKCA Mark)	171
15 Specifications	173
15.1 Matrix Frame Capabilities	173
15.2 Mechanical	173
15.3 Environmental	174
15.4 Matrix Frame Performance	174
15.5 E-MADI64 Interface Front Card	175
15.6 E-MADI64 Interface Rear Card	175
15.7 E-MADI64 Fiber Cable	175

15.8 E-MADI64 Fiber Transceiver	176
15.9 E-MADI64 Clock Sources	177
15.10 Fiber Interface Front Card	180
15.11 Fiber Interface Rear Card	180
15.12 Fiber Cable	180
15.13 Fiber Transceiver	181
15.14 E-QUE Interface Front Card	181
15.15 E-QUE Interface Rear Card	181
15.16 IVC-32 Interface Front Card	182
15.17 IVC-32 Interface Rear Card	182
15.18 LMC-64 interface front card	183
15.19 LMC-64 Interface Rear Card	183
15.20 E-DANTE64-HX Interface Front Card	183
15.21 E-DANTE64-HX Interface Rear Card	184
15.22 E-DANTE64-HX LAN Connectors	184
15.23 E-DANTE64-HX SFP Modules	184
15.24 E-DANTE64-HX Sample Rates and Available Channels	185
15.25 E-IPA-HX Card	185
15.26 Analog Port Card (MVX-A16) (Cards Mark 1. & Mark 2.)	186
15.27 Data Interface: 16 Bi-directional	187
15.28 Backplane Connector: FCI/BERG Metral	187
15.29 Power supply Unit	187
16 Limited Warranty	189
16.1 Warranty Period	189
16.2 Technical Support	189
16.3 Warranty Repairs and Returns	190
16.4 Non-Warranty Repairs and Returns	191
16.5 Extended Warranty	191
16.6 Service Contract	191
16.7 Liability	192

1 Important Safety Instructions

1. Read these instructions.
2. Keep these instructions.
3. Heed all warnings.
4. Follow all instructions.
5. Do not use this apparatus near water.
6. Clean only with dry cloth.
7. Do not block any ventilation openings. Install in accordance with the manufacturer's instructions.
8. Do not install near any heat sources such as radiators, heat registers, stoves, or other apparatus (including amplifiers) that produce heat.
9. Do not defeat the safety purpose of the polarized or grounding-type plug. A polarized plug has two blades, with one wider than the other. A grounding-type plug has two blades and a third grounding prong. The wide blade or the third prong are provided for your safety. If the provided plug does not fit into your outlet, consult an electrician for replacement of the obsolete outlet.
10. Protect the power cord from being walked on or pinched particularly at plugs, convenience receptacles, and the point where they exit from the apparatus.
11. Only use attachments/accessories specified by the manufacturer.
12. Use only with the cart, stand, tripod, bracket, or table specified by the manufacturer, or sold with the apparatus. When a cart is used, use caution when moving the cart/apparatus combination to avoid injury from tip-over.
13. Unplug this apparatus during lightning storms or when unused for long periods of time.
14. Refer all servicing to qualified service personnel. Servicing is required when the apparatus has been damaged in any way, such as power-supply cord or plug is damaged, liquid has been spilled or objects have fallen into the apparatus, the apparatus has been exposed to rain or moisture, does not operate normally, or has been dropped.
15. **WARNING:** To reduce the risk of fire or electric shock, do not expose this product to rain or moisture.

Please familiarize yourself with the safety symbols in the image below. When you see these symbols on this product, they warn you of the potential danger of electric shock if the main station is used improperly. They also refer you to important operating and maintenance instructions in the manual.

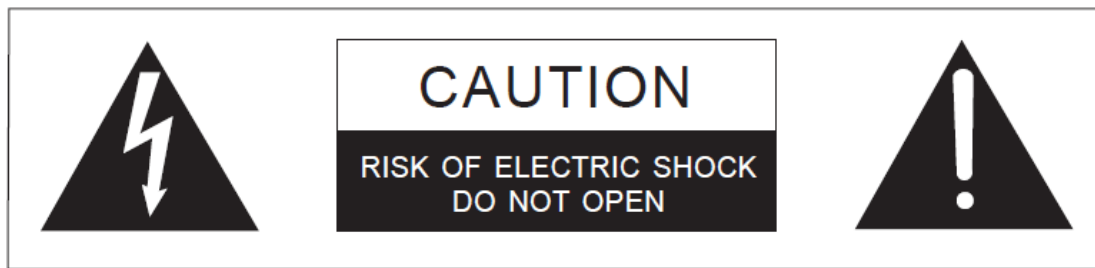

This symbol alerts you to the presence of uninsulated dangerous voltage within the product's enclosure that might be of sufficient magnitude to constitute a risk of electric shock. Do not open the product's case.



This symbol informs you that important operating and maintenance instructions are included in the literature accompanying this product.



Disconnect Power Sources

EMC AND SAFETY

This Product's power supply meets all relevant CE, FCC, UL, and CSA specifications set out below:

EN 55032 - Electromagnetic compatibility of multimedia equipment - Emission requirements

EN 55035 - Electromagnetic compatibility of multimedia equipment - Immunity requirements

IEC 62368-1, UL 62368-1, CAN/CSA C22.2 No. 62368-1:14 - Safety Requirements.

And thereby compliance with the requirement of Electromagnetic Compatibility Directive 2014/30/EU and Low Voltage Directive 2014/35/EU.

This device complies with Part 15 of the FCC Rules. Operation is subject to the following two conditions: (1) this device may not cause harmful interference, and (2) this device must accept any interference received, including interference that may cause undesired operation.

2 Introduction

The Eclipse HX system is a digital point-to-point intercom platform, designed to seamlessly integrate your entire intercom infrastructure (digital, wireless, IP-based and analog intercom systems). The system comprises matrices, interface cards and modules, user panels and interface frames.

At the heart of the system is the central matrix, comprising a matrix frame and the highly intuitive EHX configuration software, run from an external PC. This user guide describes how to use the **Eclipse HX-Median**, a 6RU matrix with 2 CPU and 7 interface card slots and 8 built-in interface module slots.

This guide:

- Provides an overview of the Eclipse HX-Median, including the interface modules and cards that you can fit to the matrix.
- Describes how to install, use and maintain an Eclipse HX-Median.
- Describes how to use E-FIB fiber interface cards to link matrices together.
- Describes how to use the E-MADI64, E-QUE, IVC-32 and LMC-64, E-Dante and E-IPA interface cards.
- Provides detailed specifications.

2.1 Further Information

For more detailed information about installing an Eclipse HX system, see the ***Eclipse HX Matrix Installation Guide***.

For more information about EHX configuration software, see your EHX documentation, including **EHX Help** (integrated with your software).

For more information about any of the Eclipse HX system components referenced in this guide (including matrices, interface cards, interface modules and EHX configuration software), see the specific manual / documentation for that device or software.

Eclipse HX documentation is available from:

- The Clear-Com website (<https://www.clearcom.com>).



For sales information, see your Clear-Com sales representative. For contact information, see the **Technical Support** section.

3 Overview

This section provides an overview of the Eclipse HX-Median matrix frame, including the interface cards and interface modules that can be fitted to the frame.

3.1 Eclipse HX Matrix Frames

There are **four** types of Eclipse HX matrix frame available from Clear-Com:

Matrix	Description
<p>Eclipse HX-Median</p> 	<p>The Eclipse HX-Median has slots for 2 CPU cards, 7 interface cards, and 8 interface modules in a six rack unit (6RU) frame. For more information, see this guide.</p>
<p>Eclipse HX-Omega</p> 	<p>The largest matrix frame in the Eclipse HX range. The Eclipse HX-Omega has slots for 2 CPU cards and 15 interface cards in a six rack unit (6RU) frame. For more information, see the Eclipse HX-Omega User Guide.</p>
<p>Eclipse HX-Delta</p> 	<p>The Eclipse HX-Delta has slots for 2 CPU cards, 4 interface cards and 3 interface modules in a three rack unit (3RU) frame. For more information, see the Eclipse HX-Delta User Guide.</p>

3.2 Interface Modules

Interface modules convert the four-wire signals of a central matrix port to other types of signals that communicate with devices such as telephones, camera intercoms, two-way radios, and so on. In this way non-four-wire devices can communicate with the central matrix.

Each interface module has hardware connectors to connect to both the central matrix and the external device that communicates with the central matrix.

Most interface modules connect to the central matrix via shielded CAT5 cable terminated with RJ-45 connectors.

Note: *The type of cable used to connect the interface module to the non-four-wire device varies with the device. For more information, see the dedicated user guide / manual for that interface module.*

The following interface modules are compatible with the Eclipse HX-Median matrix:

- **TEL-14** telephone interface module.
- **CCI-22** dual party-line interface module.
- **FOR-22** four-wire interface.
- **GPI-6** general purpose inputs interface module.
- **RLY-6** relay (general-purpose outputs) interface module.
- **AES-6** digital interface module used with V-Series panels fitted with the AES-3 option card. It may also be used with AES-3 compliant third-party equipment.

An MVX card is required to use the following interface cards:

- CCI-22
- FOR-22
- TEL-14
- AES-6

Notes: *Additional interface modules may be added to the Eclipse HX-Median, using separate interface module frames such as the IMF-3 and IMF-102. For more information, see the dedicated user guide / manual for that particular interface frame.*

DIG-2 interface modules are not compatible with the HX-Median frame format.

3.3 Interface Cards

You can fit 7 interface cards to the Eclipse HX-Median.

The number of different types of interface card you can fit to the matrix frame is limited by the available port count (112 audio ports). For more information, see the **Combining Interface Cards in the Frame** section.

Interface cards slide vertically into the front of the matrix frame and connect to the backplane.

Notes: *The term **central matrix** is used to differentiate the core hardware and software from the connected intercom panels and interfaces. The central matrix itself consists of the matrix hardware (in this case, the Eclipse HX-Median) and the EHX configuration software.*

*For detailed information about installing interface cards, see the **Installing Interface Cards** section.*

3.3.1 MVX-A16 Analog Port Card

An MVX-A16 analog port card controls the operation of panels and interfaces connected to it. Panels and interfaces connect to the port card through an RJ-45 connector (port) on the HX-Median rear panel. Shielded category-5 cable attaches the panel or interface to the RJ-45 connector.

The MVX-A16 analog port card sends balanced audio and RS-422 data signals to connected audio equipment through 4-pair shielded CAT5 cable. The card connects up to 16 audio devices (such as user panels, interfaces, or four-wire audio equipment) to the central matrix.

Each audio device connected to an analog port card communicates with all other audio devices in the system and with the central matrix.

Intelligent linking

For intelligent linking, shielded CAT5 cable is run from a port on one Eclipse HX-Median matrix to a port on a second Eclipse HX-Median matrix to form a trunkline connection.

3.3.2 E-FIB Fiber Card

E-FIB fiber interfaces connect Eclipse HX matrices together to provide a high speed, dual redundant link to transfer audio samples and data between systems. These connections can be configured to provide protection against the loss of a link or a node. E-FIB cards should be installed in the last port slot.

Each E-FIB fiber interface card set comprises:

- A front card with various status indicators.
- A rear card with two Duplex LC Terminated fiber optic connectors (**TXVRA** and **TXVRB**).

3.3.3 E-QUE E1/T1 Interface Card

The E-QUE E1/T1 interface allows the Eclipse HX-Median to connect to FreeSpeak II transceivers, FreeSpeak II transceiver splitters, and E1 and T1 trunk lines.

Each E-QUE interface card set comprises:

- A front card with a reset button and various status indicators.
- A rear card with eleven RJ-45 ports giving eight standard Ethernet ports, DECT sync in and out and a LAN port for diagnostic use.

Each E-QUE front card has status LEDs for power, port activity and LAN status. The port activity LEDs show when:

- A device is connected to an E1 port.
- A connection has been established between the E1 port and the connected device.

3.3.4 E-MADI64 Interface Card

The E-MADI64 is a MADI (*Multichannel Audio Digital Interface*) card, providing up to 64 duplex channels of AES10 digital audio over a coaxial cable or fiber pair between compatible devices.

The E-MADI64 card supports up to 32 V-Series Panels over a suitable infrastructure. See the **E-MADI64 Card** section for more information.

Note: *You have the option in EHX to limit the E-MADI64 card to either 32, 56 or 64 channels of audio. All MADI channels have standard EHX settings, including VOX and in-use tally. See also the **E-MADI64 Card** section.*

Each E-MADI64 card set comprises:

- A front card with pin reset and various status indicators (including channel quantity, sample rate, power and diagnostic (active and error) indicators).
- A rear card with a MADI fiber connector, MADI input and output coaxial cable connectors, and coaxial Video black and burst / Tri Level HD / Word clock sync input.

3.3.5 E-DANTE64-HX Interface Card

This is a Clear-Com matrix interface card that is enabled to work with Dante network protocols and software. Using the E-DANTE64-HX card you can transport many channels of high quality audio via a Clear-Com matrix to multiple Dante enabled devices using standard Ethernet network structure (up to 64 channels per E-DANTE64 card).

You can configure each E-DANTE64-HX card with EHX configuration software to support up to 16, 32 or 64 cards.

Note: *Dante enabled devices also interface with AES67 devices.*

Each E-DANTE64-HX card set consists of:

- A front panel with a reset button and status LEDs
- A rear panel with network connectors and status LEDs.

For more information, see the **E-DANTE64-HX Card** section.

3.3.6 IVC-32 IP Interface Card

The IVC-32 interface allows the Eclipse HX matrix to connect to IP enabled V-Series panels using an IP network.

Each IVC-32 interface comprises:

- A front card with a reset button and various status indicators.
- A rear card with eleven RJ-45 ports giving eight E1/T1 ports (not used), DECT sync in and out (not used) and a LAN port for IP connectivity.

Each IVC-32 front card has status LEDs for power, port activity and LAN status.

The LAN indicators show whether there is a LAN connection and the IP activity on the LAN port.

IVC-32 Redundant Card

You can add an IVC-32 Redundant Card that provides fail-over redundancy for one or more IVC-32 Cards in the matrix.

An IVC-32 Card will fail-over to the IVC-32 Redundant Card under the following conditions:

- All configured VoIP ports are unconnected for longer than 90 seconds.
- The IVC-32 Card is detected as absent from the VME backplane.
- It is requested via the EHX Event Log.

A switch back from a redundant card back to a failed card only occurs under the following condition:

- The redundant card has failed. If the original card is still in error, then it will switch back and forward until corrective action is taken.

3.3.7 LMC-64 Interface Card

The LMC-64 interface allows the Eclipse HX-Median to provide Dynam-EC (routing software) clients with audio level metering of partylines (conferences) and four-wire ports over an IP network.

Each LMC-64 interface comprises:

- A front card with a reset button and various status indicators.
- A rear card with eleven RJ-45 ports giving eight E1/T1 ports (not used), DECT sync in and out (not used) and a LAN port for IP connectivity.

Each LMC-64 front card has status LEDs for power, port activity and LAN status. The LAN indicators show whether there is a LAN connection and the IP activity on the LAN port.

3.3.8 E-IPA-HX High Capacity IP Interface Card

The E-IPA-HX card is a high capacity internet protocol (IP) audio card. It provides up to 64 connections.

The card will offer both IVC ports and FSII IP transceiver support. This can be a combination of up to 64 IP ports and/or FreeSpeak II wireless beltpack connections (according to license).

IVC-32 legacy functionality (V-series panels, Directs, trunks, LQ, and virtual clients) can run at the same time as FSII beltpacks.

The E-IPA card can be put in E1 mode (EHX v12.1 and above, 32 port license minimum). In E1 mode, the card no longer supports IP connections.

The E-IPA-HX card will only run with EHX 10.0 and above.

3.4 EHX Configuration Software

The Eclipse HX (EHX) configuration software controls the operation of the connected audio devices by sending signals to the circuit cards in the matrix, which then relay the signals to the audio devices.

Configurations (the operating parameters of complete system setups) are usually created on the EHX computer.

Up to four complete system configurations can be stored in the CPU card of the Eclipse HX-Median, for retrieval and activation when required. The external PC that hosts the EHX software can store an almost unlimited number of complete system configurations (the number is only limited by the available memory space on the PC). You can download the configurations to the Eclipse HX-Median as required.

When running EHX on Windows operating systems, the client and server can run on separate machines connected over a network. You can use EHX to perform a wide range of configuration tasks, including:

- Assigning labels (names) to ports and user panels.
- Creating point-to-point and fixed group (partyline) communications between connected audio devices.
- Enabling, limiting or disabling features of any connected user panel or card.
- Configuring connections between matrix frames.

Note: *The above list is not definitive. For more information about the capabilities of EHX, see **EHX Help**.*

The EHX system can be set up to run on a client/server model over a network, allowing the system administrator to control multiple matrices remotely.

3.5 User Panels

The following Clear-Com user panels are compatible with the Eclipse HX-Median:

- V-Series panels, including expansion panels.
- i-Series panels, including expansion panels.

Note: For more information about installing, using and maintaining user panels, and connecting user panels to the matrix, see either:

- **V-Series Panels Guide.**
- **i-Series Panels Guide.**

3.6 Eclipse HX-Median

A complete Eclipse HX-Median system consists of a central matrix and the remote audio devices (which may include user panels, interface cards, interface modules, four-wire devices and systems) connected to it.

Note: The term **central matrix** is used to differentiate the core hardware and software from the connected user panels and interfaces. The central matrix itself consists of the matrix hardware (the Eclipse HX-Median matrix frame) and the EHX configuration software.

3.6.1 Chassis and Assembly





The **matrix chassis** is a metal rectangular box which measures six rack units (6RU) high and 19-inches wide (26.9 cm x 48.3 cm). The Eclipse HX-Median has twin power supplies, and slots for 2 CPU cards, 7 interface cards, and 8 interface modules.

RJ-45 and fiber-optic connectors are located on removable plates on the rear of the chassis. These connect the circuit cards to intercom devices and media such as panels, interfaces, four-wire audio equipment, wireless equipment and fiber-optic cables.

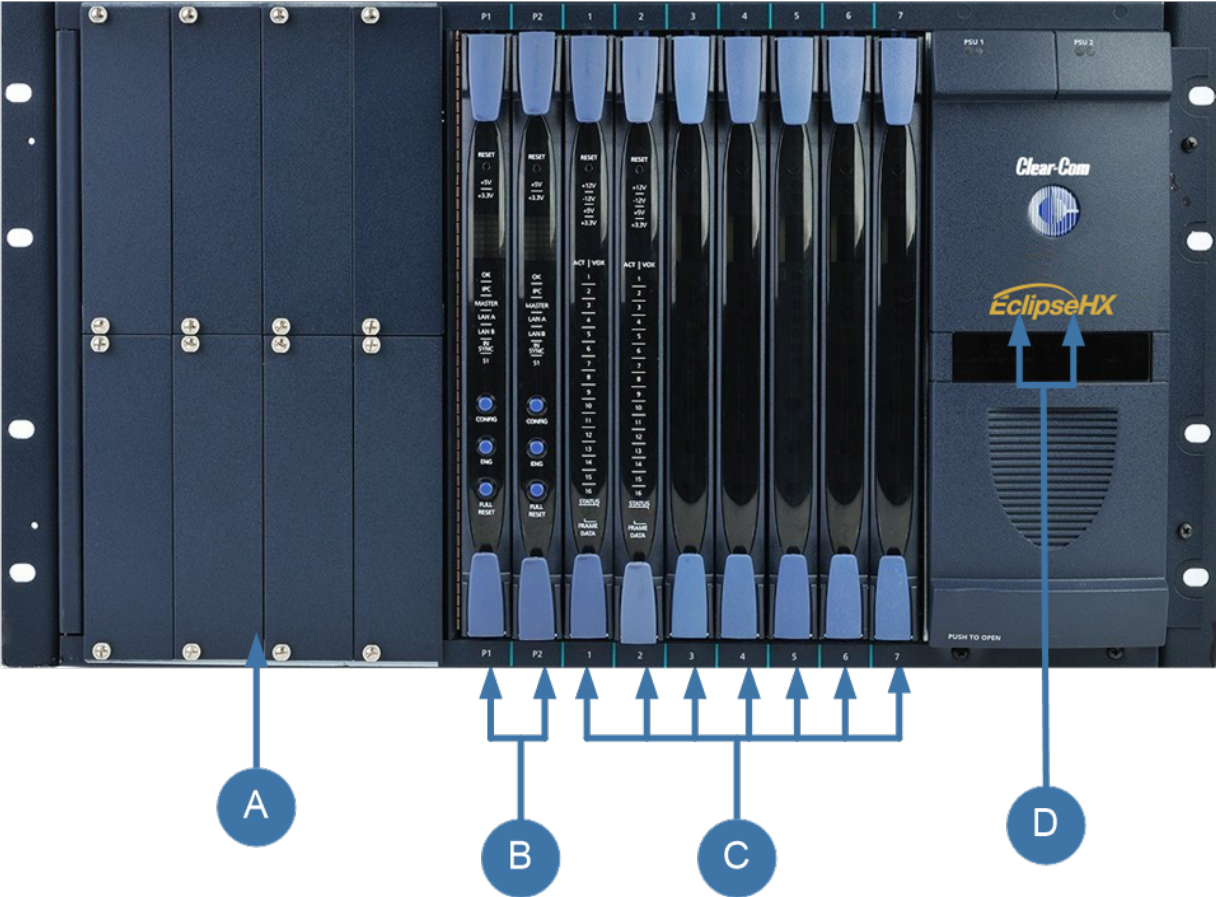



The matrix assembly consists of the following components:

- The metal chassis for the circuit cards and power supplies.
- The removable and replaceable circuit cards.
- The removable and replaceable power supplies.
- The rear panel connectors which link the circuit cards to devices and media such as user panels, interfaces, wireless equipment and optical fiber.

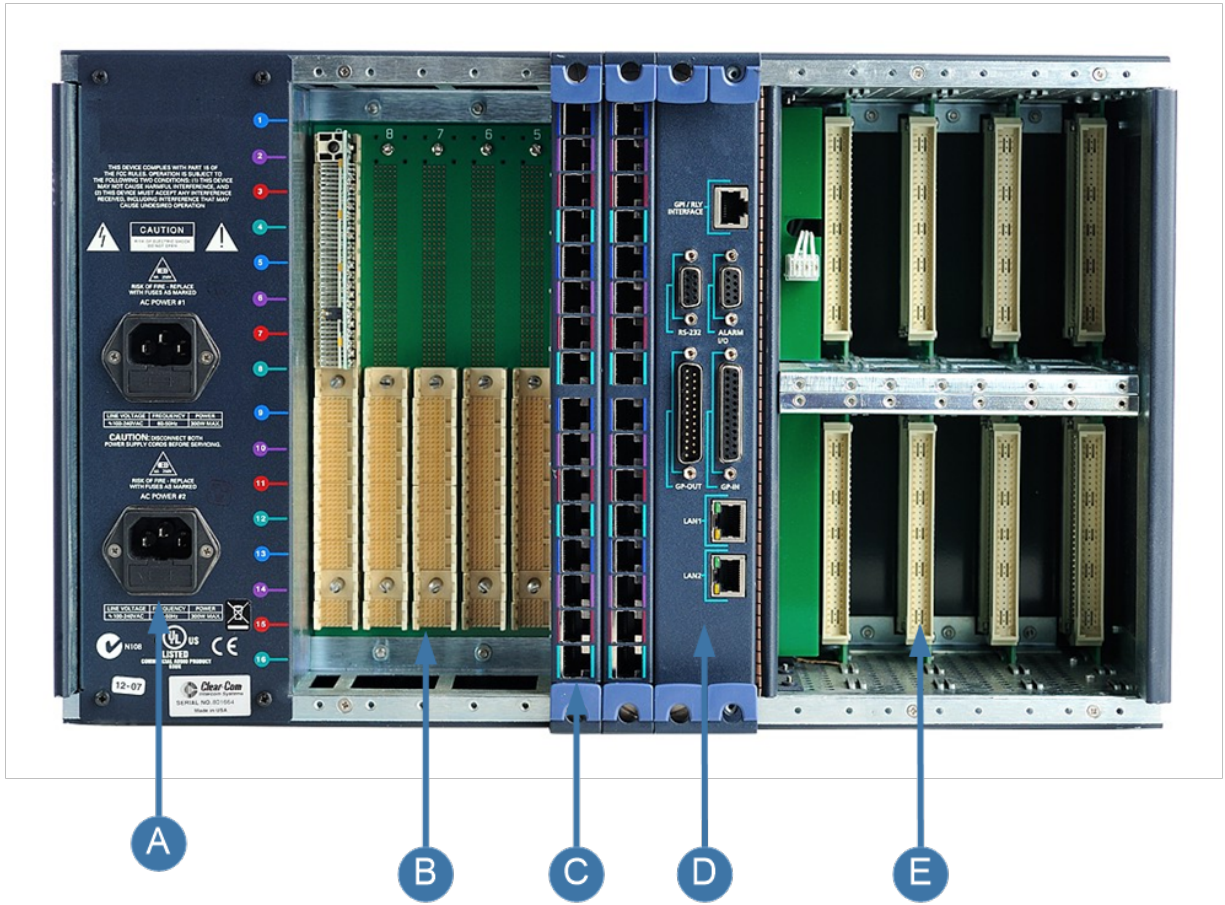

Key: Eclipse HX-Median front panel	
Feature	Description
	Interface module slots (unused in this example). The Eclipse HX-Median can house up to 8 interface modules. Blank panels can be installed to unused slots. For more information about interface modules, see the Interface Modules section.
	CPU cards (P1 and P2). 2 CPU cards are supplied with the matrix, but only one rear-panel CPU card is required. Whichever of the two front-installed CPU cards is acting as master will work in conjunction with this card. For more information, see the CPU Card section.
	Interface cards. Up to 7 interface cards can be installed to the matrix. Blank panels can be installed to unused slots. For more information, see the Interface Cards section. In the diagram below, the cards shown in slots 1 and 2 are MVX-A16 analog port cards. MVX-A16 cards are used to connect user panels and interfaces. For more information about MVX-A16 cards, see the MVX-A16 Analog Port Card section.
	Twin power supplies. The two Euro Cassette power supply units can be easily installed or removed as required. One power supply unit can power an entire matrix. The second unit provides a backup in case of failure or damage to the first unit. For more information, see the Power Supplies section.



Key to Figure 3: Eclipse HX-Median rear panel	
Feature	Description
	IEC power supply connectors. For more information about the twin power supplies, see the Power Supplies section.
	Spare slots for interface card rear connector panels. All front installed interface cards require a corresponding rear connector panel. Blank panels can be installed to unused slots. The Eclipse HX-Median has 7 slots available for interface cards. For more information, see the Interface Cards section.
	MVX-A16 analog interface card rear connector panel. An MVX-A16 rear connector panel has 16 RJ-45 connectors for connecting intercom panels and interfaces. For more information about MVX-A16 cards, see the MVX-A16 Analog Port Card section.
	CPU card rear panel. The CPU card rear panel houses connectors for an external PC, network, interfaces, alarms and other matrices. Up to 2 CPU cards can be installed to the matrix, but only one rear-panel CPU card is required. Whichever of the two front-installed CPU cards is acting as master will work in conjunction with this card. For more information, see the CPU Card section.
	Interface module slots. The Eclipse HX-Median has 8 built-in interface module slots. For more information, see the Interface Modules section.

3.6.2 Power Supplies

The Eclipse HX-Median matrix has **two Euro Cassette power supply units** that can be easily installed or removed as needed. One power supply unit can power an entire matrix. The second unit provides a backup in case of failure or damage to the first unit.

In addition, the two supplies have separate IEC connectors to AC mains and are designed for completely automatic and transparent changeover between supplies in the event of a power outage in one of the AC mains circuits.

An over-temperature sensor is connected to both an audible failure alarm and a warning light, allowing the system operator to diagnose and correct any power anomalies while the system remains operational.

Eclipse HX-Median matrices may be fitted with **XP (part 740101Z)** or **Power-One/Bel Fuse (part 720379Z)** power supply units, depending on the date of manufacture.

	<p>The different types of power supply units must not be mixed in an HX-Median matrix; if one of the pair of power supplies is replaced it must be replaced with the same type of power supply unit. If this is not possible both power supplies must be replaced with power supply units of the same type.</p> <p>Power-One/Bel Fusepower supplies are identified by the part number on the front of the unit. XP units do not have a part number on the front of the unit.</p>
---	---

Note: For information about diagnosing power supply issues, see the **Diagnosing Power Supply Problems** section.

3.6.3 Main Features of the Eclipse HX-Median

Features of the Eclipse HX-Median matrix system include:

- A six rack-unit (6RU) frame.
- Full audio bandwidth throughout the signal chain, producing superior broadcast audio quality. The system maintains 24-bit depth, a sampling rate of 48 kHz, and 30 Hz to 22 kHz frequency response.
- Support for 7 analog port interface cards (MVX-A16), providing 16 analog ports each.
- Support for 8 interface modules, which you can use to connect the matrix to telephones, two-way radios, camera intercoms, partylines, and other forms of communication.
- Fail-safe redundancy is achieved with two CPU cards and two power supplies.

Note: Power supplies automatically switch to the correct voltage, for compatibility around the world.

- Eight general purpose inputs and eight relays, located directly on the matrix.
- Full compatibility with V-Series and i-Series user panels.
- Matrices that link across cities, nations, or continents through trunk lines.
- Uses the same fiber-networking interface as the Eclipse HX-Omega matrix.

- Connection to FreeSpeak II antennas and splitters using the E-QUE or E-IPA interface card.
- Connection to IP enabled V-Series panels, virtual clients, Direct, LQ and trunk interfaces over IP networks using the IVC-32 or E-IPA interface card.
- Audio level metering over IP networks using the LMC-64 interface card.
- Up to 64 duplex channels of AES10 audio over a coaxial cable or fiber pair using a single E-MADI64 interface card.
- VOX-programmable audio, which visually cues you at the matrix when audio transmits at a programmed threshold on a connected user panel or interface.
- Visual and intuitive EHX configuration software.

Note: *The number of interface cards that can be fitted to the matrix is limited by port count. For more information, see the **Combining Interface Cards in the Frame** section.*

3.6.4 CPU Card

Note: *From Eclipse HX 13.1 Rev B, the CPU card comes in two versions, MK I and MK II. For information about compatibility, upgrading or downgrading, refer to the Eclipse HX Upgrade Guide, PUB-00238 Rev C.*

Two CPU cards are fitted to each Eclipse HX-Median system, in a master and slave relationship. The second CPU card provides redundancy in the case of outages or planned maintenance.

The master CPU card:

- Provides the serial data and Ethernet connection to the connected EHX PC.
- Coordinates the data flow between the other interface cards and modules in the system, allowing them to communicate with each other.
- Stores up to four complete configurations, enabling the selection and activation of a configuration directly from the card.
- Includes an additional, embedded configuration, which may be activated from the card for fast fault checking after the installation or upgrade of the Eclipse HX system.

Notes: *A configuration determines the operating parameters of the Eclipse HX matrix system, including port functions, talk-and-listen audio routes, controls and other functions. Configurations are created and managed in EHX, for download to the matrix frame(s). For more information about EHX, see the **EHX Configuration Software** section.*
The cards slide vertically into the front of the matrix and connect to the backplane.

4 Installing the Eclipse HX-Median

This section describes how to install the Eclipse HX-Median, including the power supplies, CPU cards, interface cards and modules.

4.1 Cabling Recommendations

Clear-Com recommends the following cabling.

Clear-Com CAT5e/6a cable recommendations	
Category (CAT)	Higher CAT numbers will support a higher bandwidth. Therefore, by using a higher CAT number, you are future proofing your system to some extent. Example: <ul style="list-style-type: none"> • Cat5: up to 1G • Cat6a: up to 10G. Use CAT5e or higher.
American Wire Guage (AWG)	The lower the AWG number, the less temperature rise there will be in the cable when using PoE. This is particularly important for bundles. Local building regulations may rule out the use of 26AWG or higher, depending on the installation. Check with your local building regulations. Use AWG 24 or lower.
Shielded Twisted Pair (STP) or Foiled Twisted Pair (FTP)	Using shielded cable means less problems with interference from other sources. This means that your network will be more robust if you use shielded cables.
Overall Recommendation	Use CAT6a 23 AWG STP cable.

4.2 Before you Begin the Installation

4.2.1 Check the Shipment

When the Eclipse HX-Median is received, inspect the boxes for shipping damage. Report any shipping damage to the carrier.

Check the packing list and verify that every item on the list has been received. Save all packing materials in the event that any items need to be returned.

Note: The Eclipse distributor is **not** responsible for shipping damage.

4.2.2 Unpacking the System

When the Eclipse HX-Median system is received the circuit cards (CPU cards and interface cards), power supplies, and rear-connector panels are pre-installed in the matrix chassis.

The customer must supply:

- The standard 19-inch rack in which to install the matrix.
- A personal computer to run the EHX configuration software.

Note: See the *Minimum PS Requirements (for EHX Software and the Recommended Requirements (for EHX Software))* sections respectively.

- CAT5 cables (to connect the matrix to user panels, interface modules, and other devices). Clear-Com recommends shielded cables.

4.2.3 Reconnecting the CPU Card's Backup Battery

Important: Before the matrix is installed, the CPU card's backup battery **must** be connected. The matrix will operate if the battery is not reconnected. However, if the matrix is powered down, all run time information (dynamic assignments, crosspoint states and levels) **will be lost**.

Battery activation and deactivation should be carried out by qualified service personnel.

The matrix CPU card has a lithium backup battery that powers the CPU memory if the AC electricity fails.



Observe anti-static procedures. The CPU card can be damaged by static electricity. Personnel reconnecting the battery should ensure that they ground themselves and all tools before touching cards.

Reconnecting the CPU memory's backup battery

1. Locate **CON9** on the centermost, upper portion of the CPU card. **CON9** will either be a **slider** (newer cards) or a **jumper** (older cards). See below for an illustration of each type of card.
2. Ensure that the slider/jumper is in the **ON** position.
 - Note: the action on the jumper is a lift movement. The action on the slider is a sideways slide.
3. The battery is now powered.

Old style CPU card with Jumper

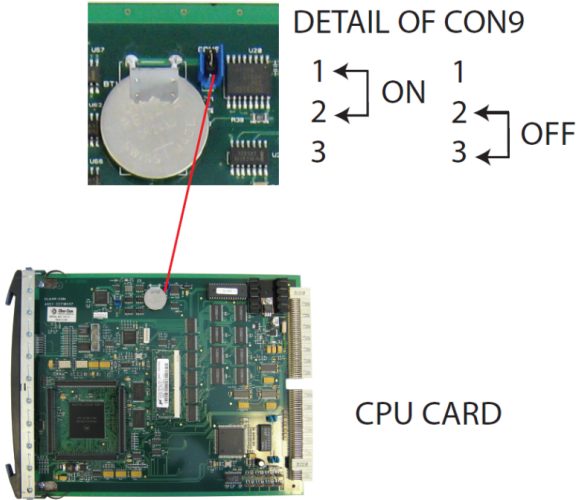

Note: LIFT the jumper.

Pin	Status
1	On
2	Common
3	Off

Note When servicing the battery, make sure that the slider/jumper on CON9 is definitely ON or OFF. If the common is left floating, the CPU may behave unpredictably. For example, the microprocessor may reset itself intermittently.

New Style CPU Card with Slider

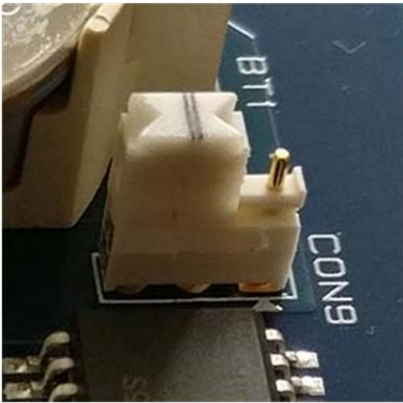
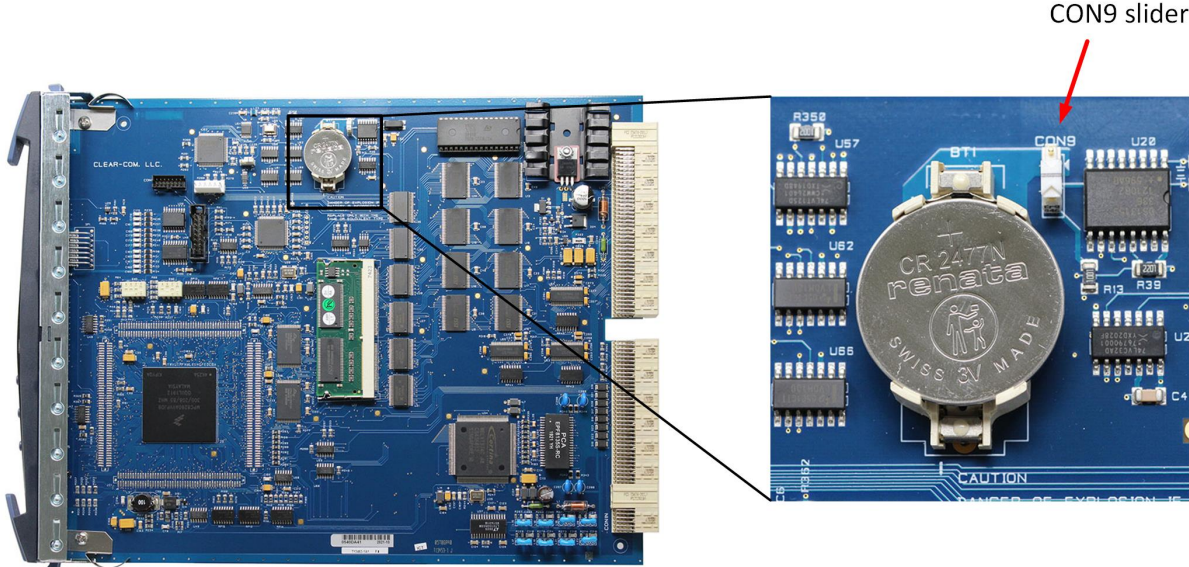

OFF position

Slide \rightarrow To turn battery ON

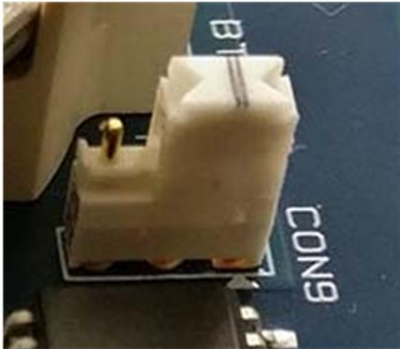

ON position

Changing the battery

Matrix CPU cards are fitted with a socketed battery which is normally a Renata CR2477N with a capacity of 950mAh and a life of approximately 247 days. These socketed batteries are easily replaced and this operation does not have to be carried out by service personnel.

Disconnecting the CPU backup battery

Before performing any service on the CPU card, the backup battery must be disconnected. To do so, place the CON9 jumpers / slider in the OFF position as described in the previous procedure.

If the matrix is going to be stored for more than 3 months, the CPU backup battery needs to be temporarily deactivated while the matrix is stored.

To do so, put the CON9 jumpers / slider in the OFF position as described above. In order to power up and start operating the matrix, reconnect the CPU backup battery by placing the CON9 jumpers / slider in the ON position, as described above.

Low Power Warning

If the CPU card is left unpowered for a period of time the batteries for the battery backed up RAM may become discharged. This results in the run time information being lost.

If this state is detected by the CPU card then the CPU card will provide signalization on its **OK LED** in the form of 2 rapid flashes followed by a slow flash. If EHX is logging, then the following message will appear in the log:

Non Volatile Data is invalid - Please check Battery Voltage

If on successive power downs of the HX-Omega matrix the above state is detected, and the message appears in EHX logs, then it is advisable to check the health of the CPU card on-board battery, which should be nominally at least 2.8V.

The minimum at which the data may remain intact is around 2.5V but normally the battery should be replaced before the voltage drops to this level.



Danger of explosion if battery is incorrectly replaced. Replace only with the same or equivalent type.

Lithium batteries can overheat or explode if they are shorted. When handling the CPU card or a loose battery, **do not** touch any external electrical conductors to the battery's terminals or circuits to which the terminals are connected.

4.3 Installing the Eclipse HX-Median

The following overview gives a summary of the steps required to install an Eclipse HX-Median matrix. More detailed information on each step is provided in the sections that follow.

To install an Eclipse HX-Median:

1. Remove the Eclipse HX-Median matrix chassis from its shipping carton.
2. Install the Eclipse HX-Median to the standard 19 inch rack.
Note: Leave clearance on all sides of the matrix chassis to ensure proper airflow. Do not block ventilation vents.
3. Check the position of CPU cards and interface cards, power supplies, and rear connector panels. Later sections in this part of the guide give more information on these items.
4. Apply AC power to the unit. The unit has two separate AC power entry connectors for the two separate power supplies in the system.

4.3.1 Installing the Power Supplies

The Eclipse HX-Median system's DC power supplies run on AC mains power.

Two identical Euro Cassette power supplies are provided to ensure that every matrix has redundant power.

Each of the power supplies must be connected to a dedicated branch of AC mains power. The matrix will continue to operate even if one of the AC power branches fails.

Clear-Com supplies each matrix with power supplies already installed. When the matrix is installed connect the power supplies to AC mains power using the IEC power connectors on the matrix's rear panel.

A fully equipped Eclipse HX-Median matrix (2 CPU cards, 7 interface cards and 8 interface modules) requires 100 - 240 VAC at 50 - 60 Hz with a maximum dissipation of 300W.

4.3.2 Installing the Rear Panels

The rear panel of the matrix is constructed of modular, individually-installable connector panels. Each port or expansion card has a corresponding rear-connector panel:

- An MVX-A16 rear panel has 16 RJ-45 connectors.
- E-FIB rear panels have two fiber connectors.
- E-QUE, IVC-32 and LMC-64 rear panels have 11 RJ-45 connectors.
- 64 rear cards have a MADI fiber connector, MADI input and output coaxial cable connectors, and a coaxial Video / Word clock input.

- E-DANTE64 rear card contains Primary and Secondary RJ45 and SFP
- E-IPA rear card contains 4 RJ45 LAN, 2 SFP LAN, 2 SFP E1 connections and an USB-C service port.

Note: *Clear-Com ships each matrix with the required number of rear-connector panels already installed. Blank rear panels fill unused card slots.*

To **add** a rear panel to the matrix:

1. Remove the desired blank rear panel by loosening the screws and pulling the panel out. The screws are attached and cannot be removed.
2. Install the new rear panel by sliding the card into the card's guides at the top and bottom of the Eclipse HX-Median chassis.
3. Tighten all of the screws on the rear panel.

To **remove** a rear panel from the matrix:

1. Detach any devices connected to the rear panel's connectors.
2. Loosen the screws that hold the rear panel to the matrix. The screws are attached and will not fall off.
3. Remove the rear panel by pulling the panel out.

4.4 Installing CPU Cards

The CPU card's components include CMOS chips which are sensitive to static electricity. Before touching the CPU card touch a grounded metal object, such as any unpainted surface on the matrix, to dissipate static electricity. While handling the CPU card, be careful not to bend any of the card's connector pins or component leads.

The CPU card switch settings for normal operation (watchdog enabled) are shown in the following diagrams.

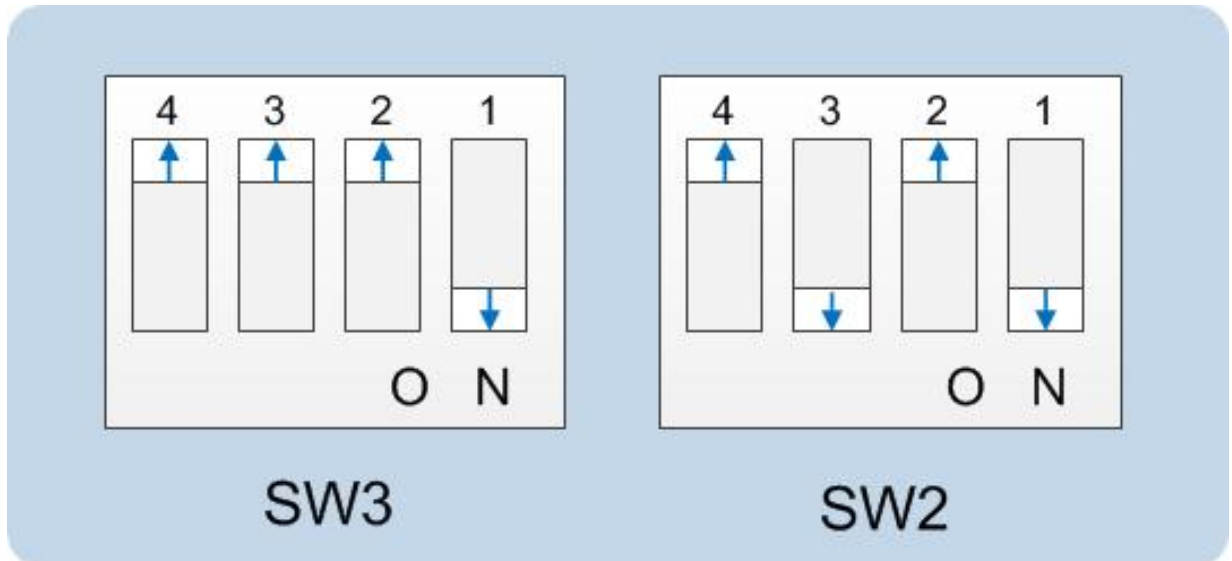

Note: Store spare CPU cards in unused slots in the matrix or in electrically insulated packaging such as anti-static heavy duty plastic bags.

To **insert** a CPU card in the matrix:

1. Carefully place the card in the appropriate slot. Make sure the card is aligned with the top and bottom precision guides.
2. When the card has almost reached the backplane connectors, open the two ejectors, allowing them to clear the edges of the matrix. Gently insert the card further until it touches the backplane connector guides.
3. Gently close both ejector tabs at the same time, which will propel the card into the backplane connectors.

To **remove** a CPU card from the matrix:

1. Hold the card in place in the matrix.
2. There are two card ejector tabs, located at the top and bottom of the CPU card. Open the two ejector tabs at the same time until the card unseats from its backplane connectors.
3. Pull the card out of the matrix.

4.4.1 Hot Patching CPU Cards

The CPU cards are **hot patchable** and self-initializing.

When the matrix is fitted with two CPU cards, a faulty CPU card can be removed and replaced while the system is powered because the second CPU card will automatically begin operating when the first card is removed. It is advisable to replace CPUs in maintenance down times.

4.4.2 Checking the CPU Card Installation

The following lights indicate that the card has been properly installed in the matrix:

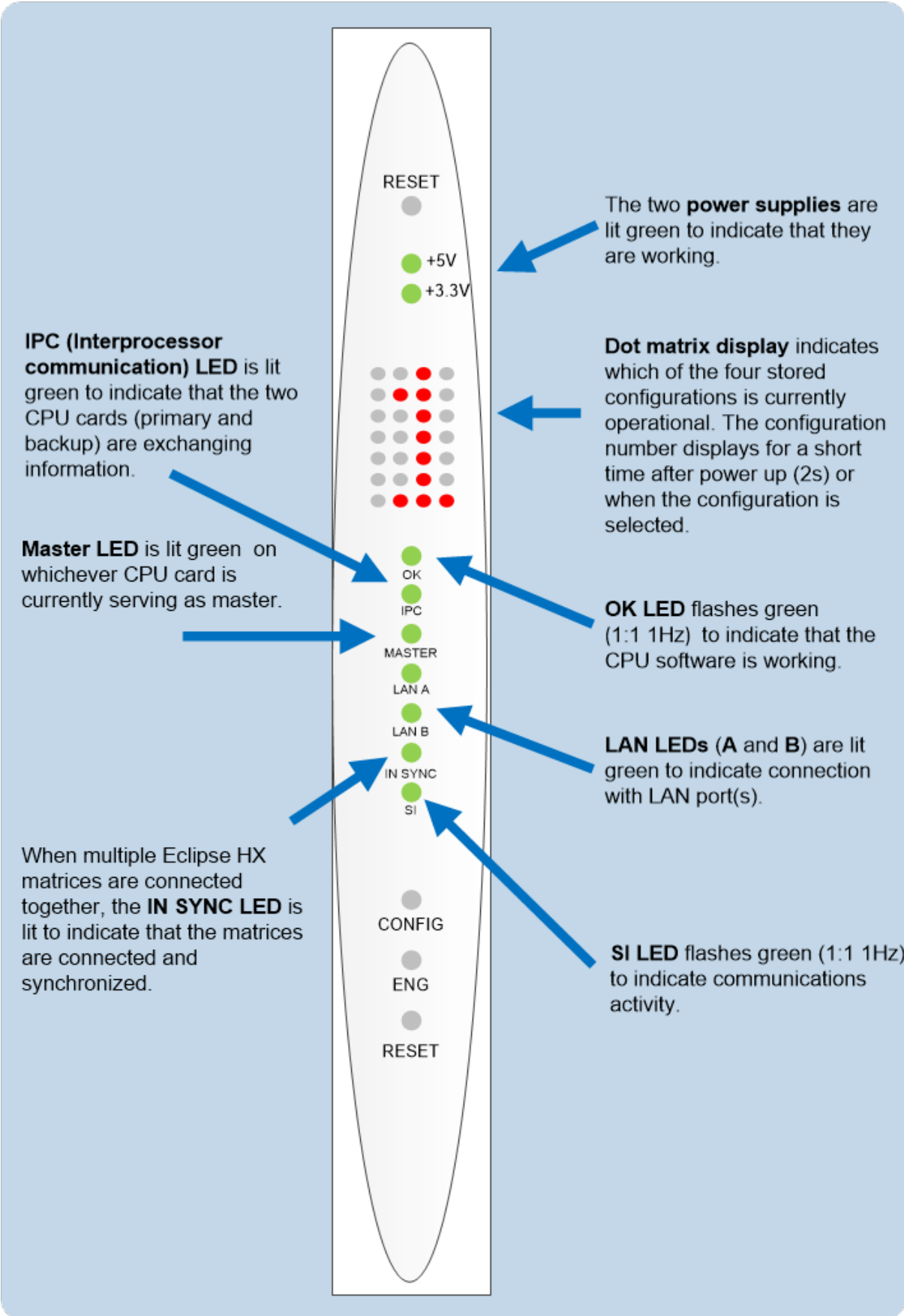

Note: Once the CPU card has initialized, you can use the **Eng** button to request frame information (such as the software version and the current IP address). For more information, see [CPU Card Lights and Controls on page 58](#).

4.5 Installing Interface Cards

4.5.1 Installing an Interface Card to the Matrix Frame

Note: Before installing an interface card, ensure that the card's associated rear-connector panel has already been installed.

To install an interface card:

1. Carefully place the card in the appropriate slot. Ensure that the card is aligned with the top and bottom precision guides.
2. Push the card toward the backplane connectors.
3. When the card has almost reached the backplane connectors, open the two ejector tabs, allowing them to clear the edges of the matrix. Gently insert the card further until it touches the backplane connector guides.
4. Gently close both ejector tabs at the same time, which will propel the card into the backplane connectors.

4.5.2 Removing an Interface Card from the Matrix Frame

To remove an interface card from the matrix frame:

1. Hold the card in place in the matrix.
2. The two card ejector tabs are located at the top and bottom of the card. To remove a card, open the two ejector tabs at the same time until the card unseats from its backplane connectors.
3. Pull the card out of the matrix.

4.5.3 Combining Interface Cards in the Frame

The Eclipse HX-Median can allocate up to 496 audio ports in total. However, the number of ports that you actually use will depend on the combination of interface cards you fit to the frame.

An **MVX-A16** card uses 16 audio ports.

An **E-MADI64** card is configured in EHX to use either 16, 32, 56 or 64 audio ports.

An **IVC-32** card uses 32 audio ports from the total.

Fitting 7 MVX-A16 cards to the Eclipse HX-Median would fill the frame, but would only use 112 ports from the possible 496 ports available:

$$7 \text{ MVX cards} * 16 \text{ ports} = 112$$

More ports can be utilized on the Eclipse HX-Median by using higher capacity interface cards, such as the E-MADI64 card. For example, if you installed 5 E-MADI64 cards, using 64 audio ports, you could add a further 2 MVX-A16 cards.

$$(5 \text{ E-MADI64 cards} * 64 \text{ ports}) + (2 \text{ MVX} * 16 \text{ ports}) = 352$$

If you fitted 4 IVC-32 cards, using 96 ports, you could add 3 more MVX-A16 cards:

$$(4 \text{ IVC-32 cards} * 32 \text{ ports}) + (3 \text{ MVX cards} * 16 \text{ ports}) = 176$$

LMC-64 cards take a port per meter. LMC-64 cards are configured in EHX to 16, 32, 48 or 64 audio meters and the same numbers of ports are allocated at that time.

When an audio level meter is configured using Dynam-EC one of the ports allocated to the LMC-64 card is used. If the same audio level meter is being used by more than one Dynam-EC client this does not increase the port usage as the audio level data is broadcast.

E-FIB cards use a port per channel. E-FIB cards can be configured to use between 16 and 192 ports.

E-QUE wireless cards (if not directly connected) use six ports per antenna.

E-QUE cards have 60 ports in E1 mode or 48 ports in T1 mode.

E-MADI cards take 32 or 64 ports.

E-DANTE cards take 16, 32 or 64 ports.

E-IPA cards take 16, 32, 48 or 64 ports.

Recommendation:

Clear-Com recommends fitting E-FIB cards on the right of the matrix frame, and fitting MVX-A16, IVC-32, E-MADI64, E-QUE E1/T1 direct cards on the left of the frame, where possible.

Note: *Comfort tones use 3 ports which normally default to using the top of the physical port range. If required, the comfort tones can be redirected to ports above 496 in **System Preferences** (for more information, see your EHX documentation).*

4.5.4 Static Sensitivity

	<p>Observe anti-static procedures. Devices can be damaged by static electricity. Personnel reconnecting the battery should ensure that they ground themselves and all tools before touching cards.</p>
---	---

A CPU / interface card's components include CMOS chips that are sensitive to static electricity. Before touching a card first touch a grounded metal object, such as any unpainted surface on

the matrix, to dissipate static electricity. When handling a card, be careful not to bend any of the card's connector pins or component leads.

Store spare cards in electrically insulated packaging, such as anti-static heavy duty plastic bags or in unused card slots (though **not** fully seated) in the matrix.

4.5.5 Hot Patching (Hot Plugging)

Interface cards are **hot patchable** and **self-initializing**, which means that a faulty card can be removed and replaced while the system is powered. Hot patching (also known as hot plugging) has no effect on any part of the system's operation, except the MVX-A16 analog card's assigned sixteen ports.

Communication with a card's connected devices will be interrupted when that card is removed from the matrix. When the card is replaced, communication is restored.

4.5.6 Analog Port Numbering

One MVX-A16 interface card supports 16 analog ports. A grid printed on the matrix's rear panel gives the numbering scheme for the analog ports.

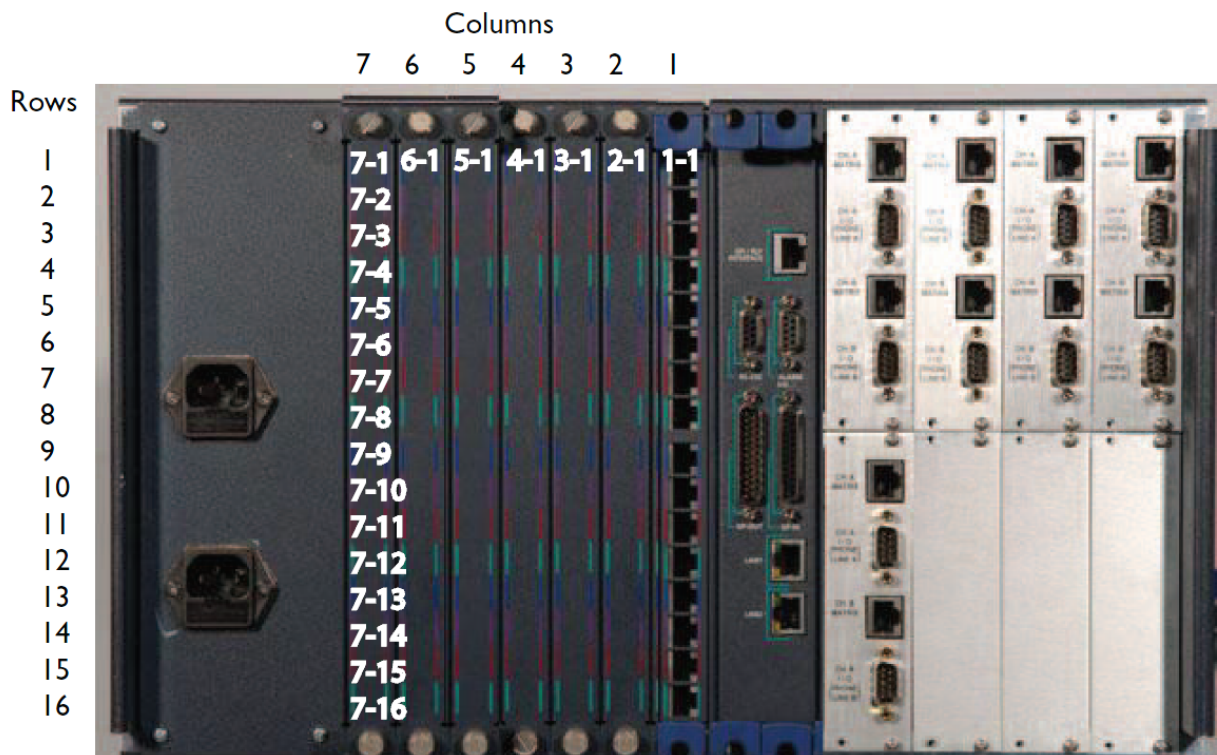

4.5.7 Checking Checking MVX-A16 Analog Port Card Installation

The following front panel lights indicate that an analog port card has been properly installed in the matrix:

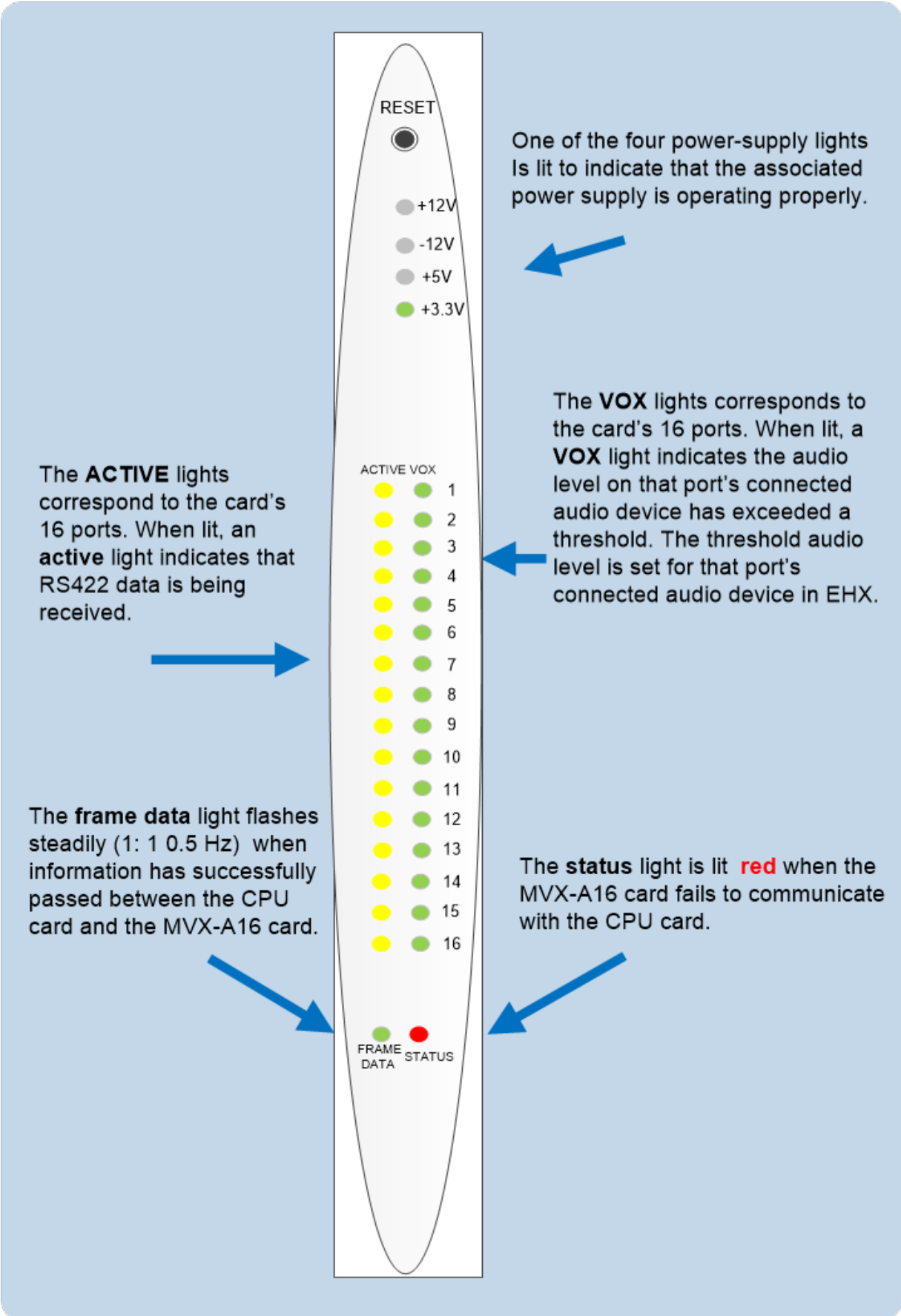

Note: For more detailed information about the MVX-A16 front panel controls and lights, see [MVX-A16 Analog Card Front-Panel Lights and Controls](#)

4.6 Wiring Audio Devices to the Matrix Frame

An external four-wire audio device can be directly connected to a port connector through the four audio pins. If there is excessive noise on the lines between the device and the matrix, the device may be electronically unbalanced with the rest of the system. The device must be isolated with external isolation transformers.

The **CALL SEND** output can be connected to the **CALL REC** input to tell the system software that this is a directly connected port.

EHX allows the changing of the audio output reference level between **-24, -21, -18, -15, -12, -9, -6, -3, 0, +3, +6, +9, +12 and +14 dB**.

With a **+12dB** output reference level, it is possible to drive a **200 - 400 Ohm** headset directly with a port output for such uses as direct IFB feed.

The EHX configuration software allows the changing of the audio input reference level between **-12, -9, -6, -3, 0, +3, +6, +9, +11 dB**.

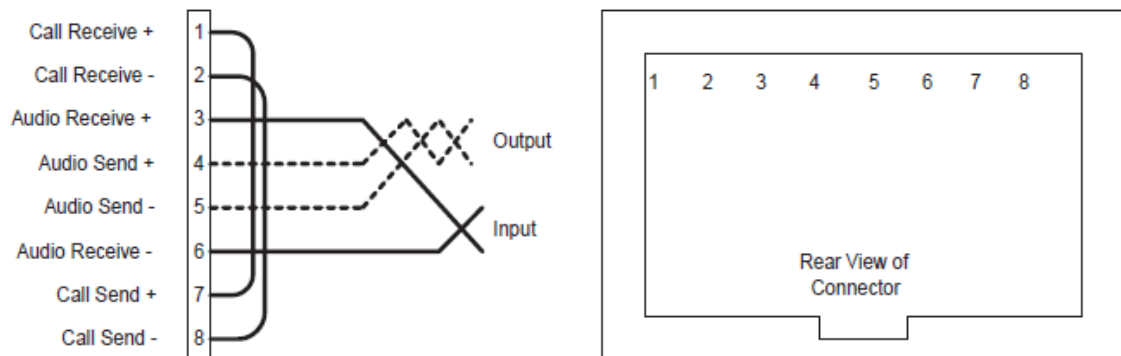

Clear-Com recommends the use of shielded cable.

Note: The *Eclipse HX Installation Guide* gives complete details about wiring audio devices to the matrix. The installation manual also discusses RJ-45 cables and other types of cable required for system installation.

4.6.1 Configuration

When an interface card is physically installed, its ports must be assigned functions in the EHX configuration software (see your **EHX documentation**).

4.7 Wiring Panels to the Matrix Frame

Eclipse HX uses a 4-pair (analog) or single-pair (digital) wiring scheme between the matrix and panels. All Eclipse HX user panels (V-Series and i-Series panels) have built-in RJ-45 connectors.

4.7.1 4-Pair Analog

Four-pair analog wiring is performed with shielded CAT5 RJ-45 cable:

Pair	Description
Pair 1	Transmits analog audio from the matrix to the panel.
Pair 2	Transmits digital data from the panel back to the matrix.
Pair 3	Transmits audio from the panel to the matrix.
Pair 4	Transmits digital data from the matrix back to the panel.

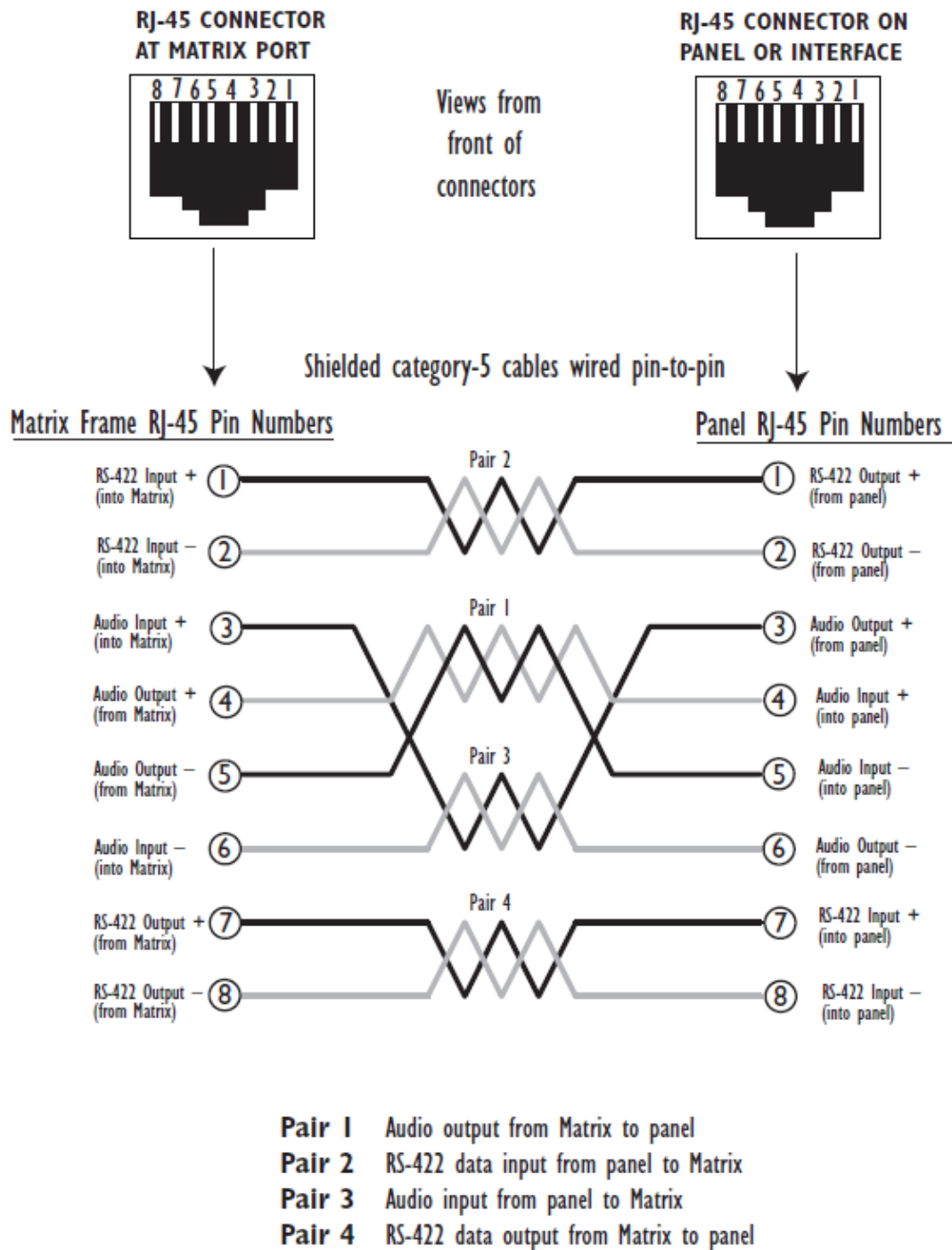

4.7.2 Single-Pair Digital

Single-pair digital wiring is accomplished with double-shielded 24 AWG conductor CAT-6E enhanced STP cable.

Pair 1 transmits and receives multiplexed digital and analog between the matrix and the panel.

Ensure that the **Select** switch on the rear of the panel is in the correct position for the intended use.

ATT-T568B (Modular Jumpers Wired One to One)

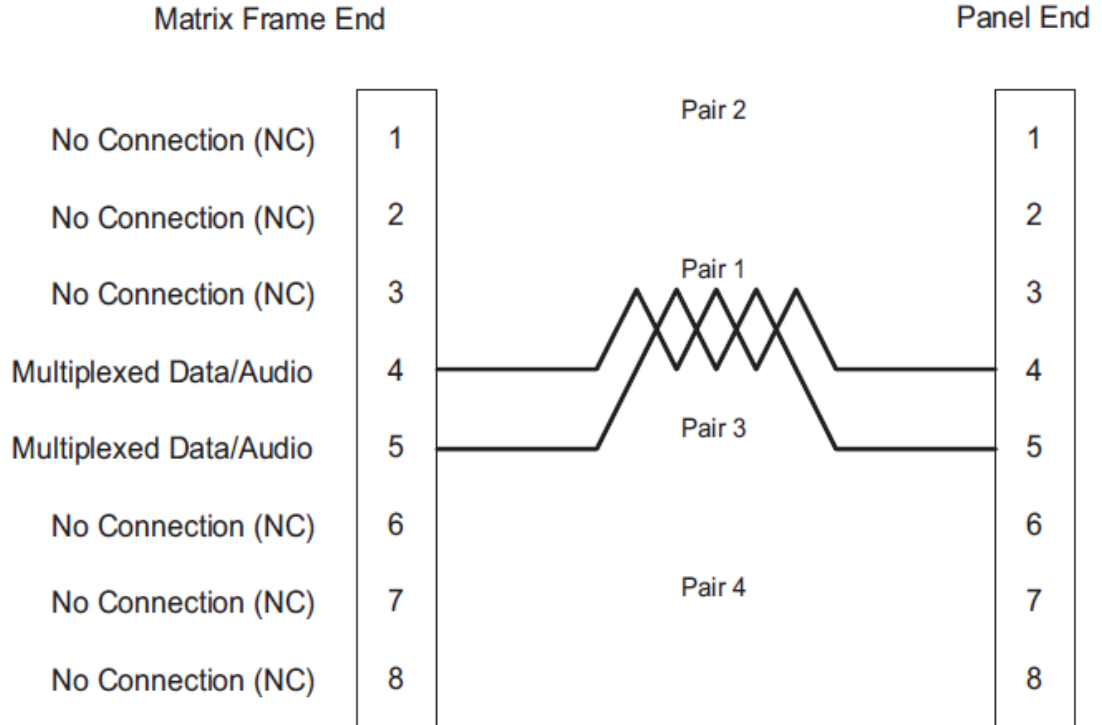

Note: The above wiring diagram refers to **DIG-2** and is shown **as an example only** (DIG-2 panels are **not** compatible with the Eclipse HX-Median).

4.8 Wiring CPU Card Interfaces

The CPU card holds the circuitry for connecting to, and communicating with, the following interfaces:

- An external personal computer.
- Alarm inputs and outputs.
- Eight general purpose inputs (GPIs).
- Eight general purpose outputs (GPOs or relays).
- Two separate local area network (LAN) connections for Ethernet-based communication with a network.
- An external GPI/RLY interface.

4.8.1 CPU Card Interface Connectors

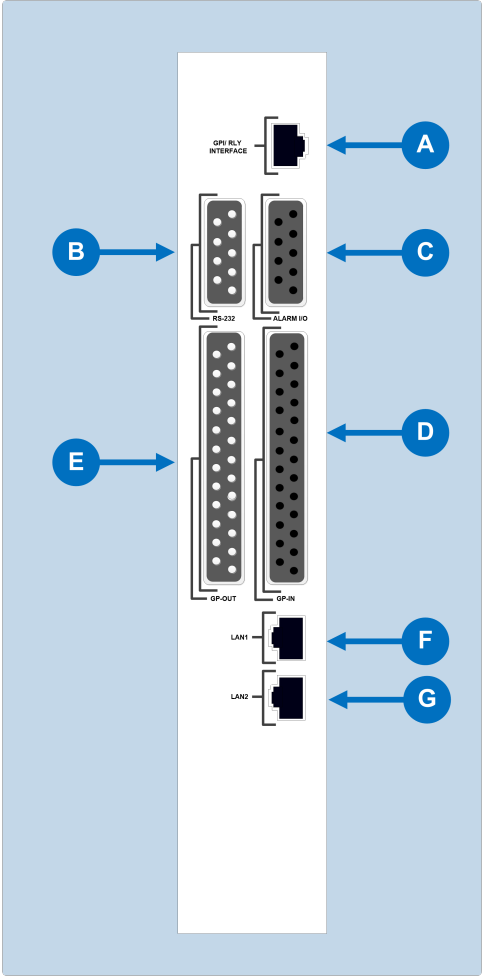

Key to CPU card interface connectors	
Feature	Description
	<p>GPI/RLY Interface Connector</p> <p>The RJ-45 socket labeled GPI/RLY Interface connects the CPU card to a GPI-6 or RLY-6 card. The GPI-6 provides six general-purpose opto-isolated logic inputs. The RLY-6 card provides six single-pole, double-throw relay outputs.</p> <p>Both card types mount in either an IMF-3 interface frame or an IMF-102 interface frame. Up to ten GPI-6 or RLY-6 cards can be operated at one time from the matrix by daisy-chaining the cards together. Each card has an IN and an OUT connector for this purpose.</p> <p>The RLY-6 and GPI-6 cards connect to the GPI/RLY interface connector using shielded category-5 cable. For more information about the GPI-6 and RLY-6 cards, consult their respective manuals in the Eclipse HX documentation set.</p> <p>Note: <i>If this port is used a ferrite core must be added to the socket end of each cable. A suitable ferrite core is Würth Elektronik part: 74271132.</i></p> <p>Clear-Com recommends the use of shielded cable.</p> <p>For wiring pinout information for GPI/RLY interfaces, see the:</p> <ul style="list-style-type: none"> • <i>Relay Interface Module (RLY-6) Instruction Manual.</i> • <i>General Purpose Inputs (GPI-6) Instruction Manual.</i>

Key to CPU card interface connectors



RS-232 DB-9 Connector

The DB-9 connector labeled RS-232 connects the Eclipse HX-Median matrix to an external computer. To connect a computer to the matrix, run cable from the RS-232 connector to the PC's serial port. The maximum recommended length of the cable is approximately 10 feet (3 meters). A computer has either a 9-pin serial port or a 25-pin serial port.

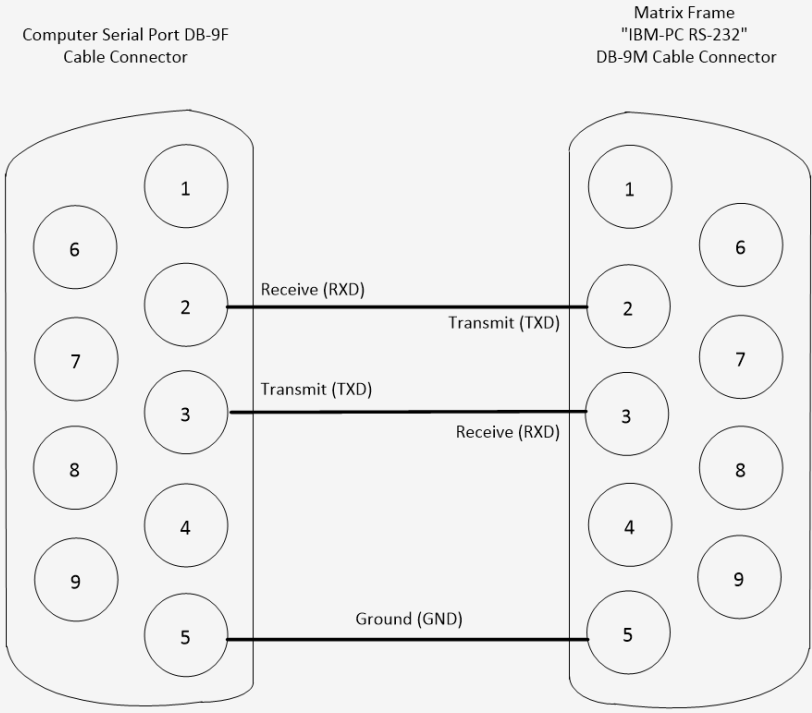

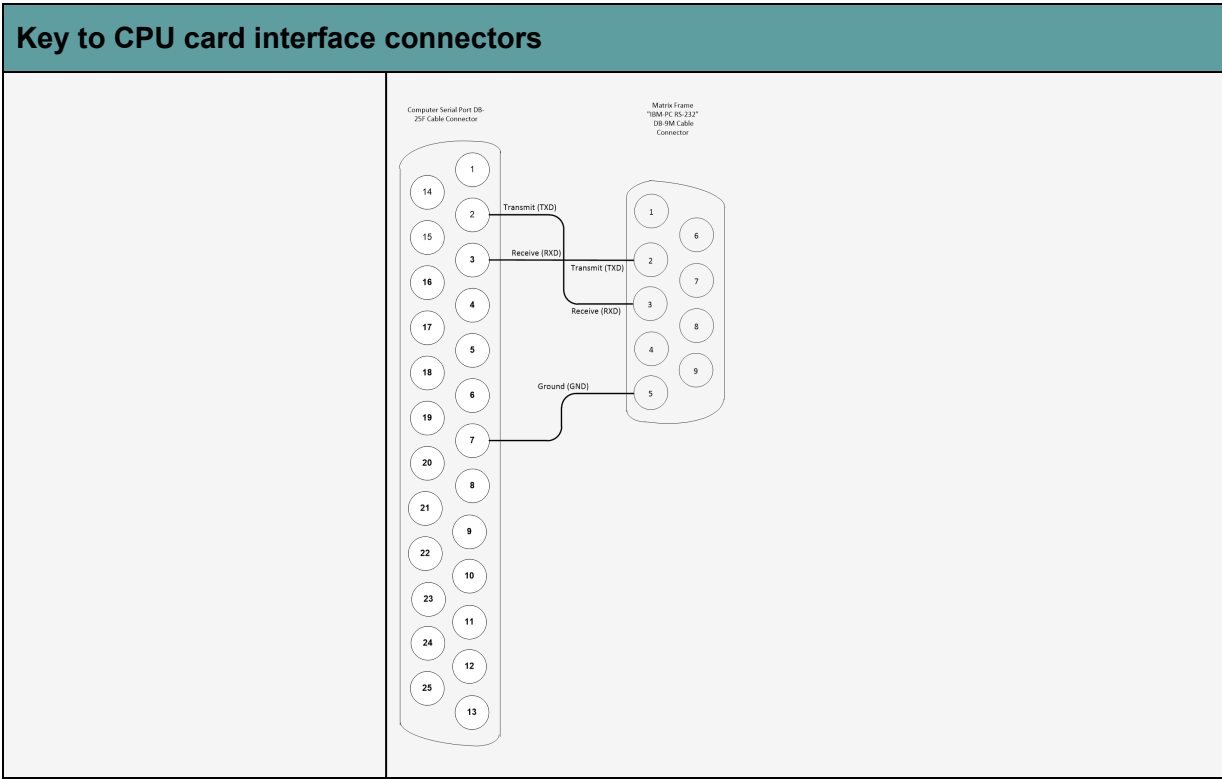

Key to CPU card interface connectors

**Alarm I/O Connector**

The DB-9F connector labeled **Alarm I/O** connects the matrix to a control circuit for an external alarm, such as a light or bell. The external alarm activates whenever an alarm condition is detected in the matrix.

The following conditions trigger an alarm:

- If any of the voltages produced by the first power supply unit fall below their normal levels.
- If any of the voltages produced by the second power supply unit fall below their normal levels.
- If an external alarm circuit or other logic circuit connected to the power supply is activated.
- If either of the two power-supply unit fans stop operating.
- If software on a master CPU card generates an alarm.

An alarm condition activates the relay contacts connected to **pins 4, 5, and 9**. These contacts are “dry”, (no voltage is supplied to them by the matrix) and are rated at **1 A at 24 VDC**. They should not be used for AC mains line current.

Pins are provided for adding an additional alarm source to the matrix’s alarm system. **Pin 6** is an alarm input to the Eclipse HX-Median matrix. It is connected to the input of a 3.3 V logic device.

A logic high on this input will cause the Eclipse HX-Median matrix to detect an alarm condition. A logic low or an open circuit means that the matrix will not detect an alarm condition.

Pin 1 is a voltage source out of the Eclipse HX-Median matrix. It is connected through a 10Kohm pull-up resistor to the +5 V supply rail inside the Eclipse HX-Median matrix.

A contact closure placed across **pins 1 and 6** will also cause an alarm condition.

Tip: The alarm outputs of the PSU-101 power supply could be wired directly to these pins allowing the CPU card to report PSU failures also.

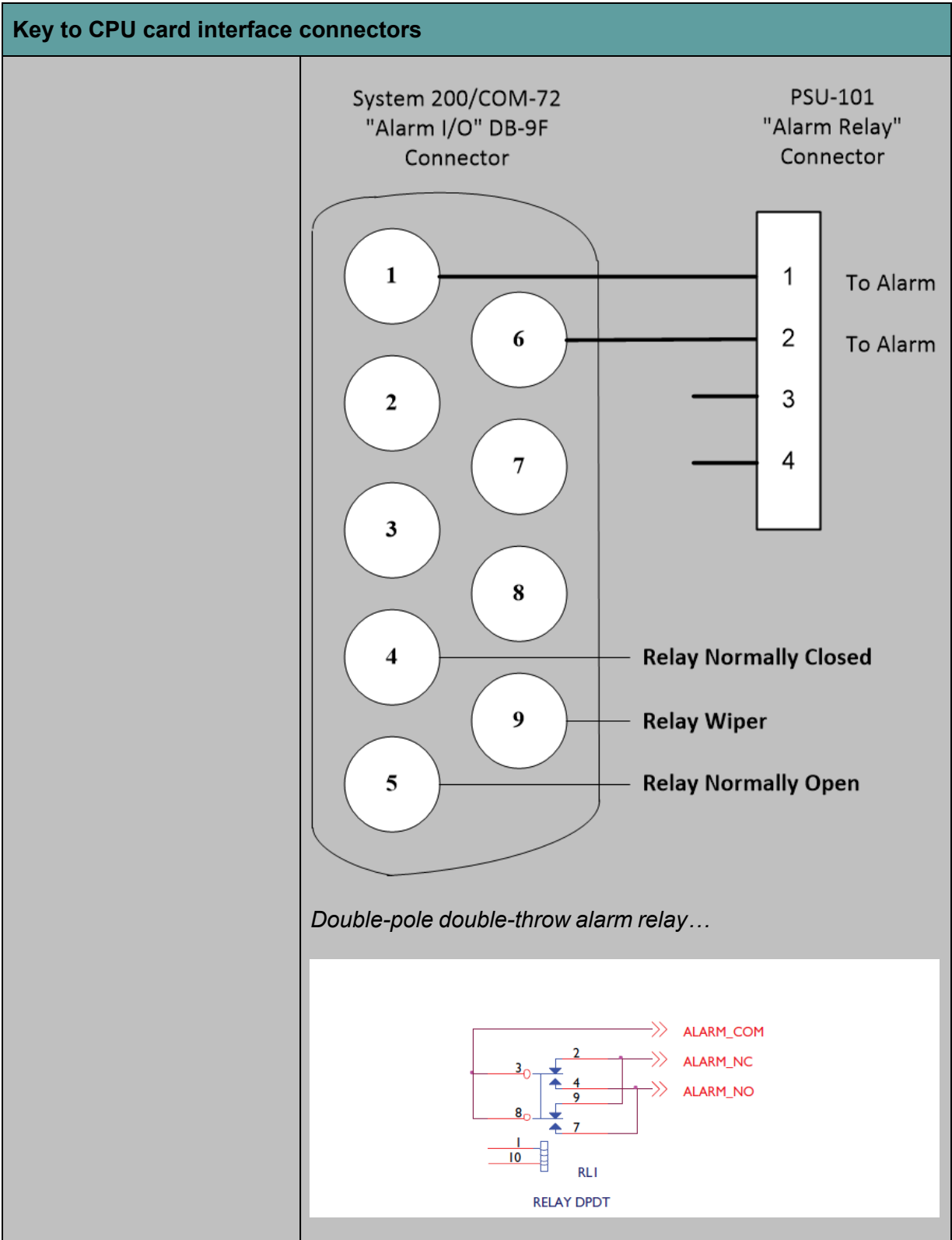

Key to CPU card interface connectors

**General-Purpose Outputs Connector (GP OUT)**

A GPO can be programmed to mute a speaker, to turn on an applause light, to turn on a door lock, or to perform a variety of other functions. For example, to get the attention of a panel operator working in a high-noise environment such as a control booth, a relay can be programmed to switch on a light at the operator panel each time an incoming call is received, to ensure that the call is not missed.

Note: *If the **GP-OUT** port is used on an Eclipse HX-Median matrix fitted with XP power supplies (part 740101Z) the following filter must be fitted between the PROC-RCC socket and the cable:*

CINCH FA-25PS/1-LF 25W D-type in-line 1000pF filter (UK supplier: Farnell 111-4108)

If the Eclipse HX-Median matrix is equipped with Power-One/Bel Fusepower supplies (part 720379Z) this filter **must not** be fitted. If this filter is already fitted to an Eclipse HX-Median matrix and the power supplies are changed to Power-One/Bel Fuseunits the filter must be removed before the matrix is powered up.

The DB-25 connector labeled **GP OUT** connects the matrix to eight double-pole double-throw (DPDT) relays with contact ratings of 30 VDC at 1A.

Each general-purpose output has a relay inside the Eclipse HX-Median matrix. When a general-purpose output is inactive, the associated **common** pin on the **GP OUT** connector will be shorted to the relevant **normally closed** pin. When a general-purpose output becomes active, the short between the **common** pin is broken and a new connection is made between the **common** pin and the **normally open** pin.

Key to CPU card interface connectors

DB-25 Male Connector

PIN	DESCRIPTION
1	RELAY 1 Common
2	RELAY 1 Normally Closed
3	RELAY 1 Normally Open
4	RELAY 2 Common
5	RELAY 2 Normally Closed
6	RELAY 2 Normally Open
7	RELAY 3 Common
8	RELAY 3 Normally Closed
9	RELAY 3 Normally Open
10	RELAY 4 Common
11	RELAY 4 Normally Closed
12	RELAY 4 Normally Open
13	GROUND
14	RELAY 5 Common
15	RELAY 5 Normally Closed
16	RELAY 5 Normally Open
17	RELAY 6 Common
18	RELAY 6 Normally Closed
19	RELAY 6 Normally Open
20	RELAY 7 Common
21	RELAY 7 Normally Closed
22	RELAY 7 Normally Open
23	RELAY 8 Common
24	RELAY 8 Normally Closed
25	RELAY 8 Normally Open

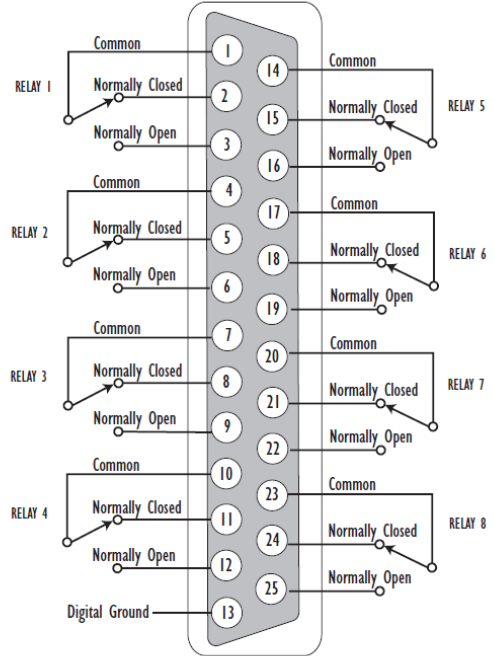

30 VDC at 1 Ampere

Key to CPU card interface connectors

**General-Purpose Inputs Connector (GP IN)**

The DB-25 connector labeled **GP IN** connects the matrix to eight local general-purpose inputs (GPIs).

An external device such as a foot switch, a panel-mounted switch or the logic output of some other device can be connected to the **GP IN** connector. When the external device is activated, it sends a control signal into the matrix to perform one of several preset functions, such as turning a user panel's microphone on or off, muting a microphone's output, or turning a panel's speaker off. The function to perform and the panel upon which it is performed is configured using EHX.

A shielded cable should be used.

The general-purpose inputs operate in one of two modes: the **opto-isolated** mode or the non-isolated mode.

The opto-isolated mode requires the externally connected equipment to provide the current to power the general-purpose input. The non-isolated mode does not require that the externally connected equipment powers the general-purpose input. The current is supplied by a voltage output on the **GP IN** connector.

To select a mode, move the J1 jumper on the CPU rear card to one of two positions. The J1 jumper is located on the inner-matrix side of the DB-25 connector.

For **opto-isolated mode**, fit the J1 jumper across pins 1 and 2.

For **non-isolated mode**, fit the J1 jumper across **pins 2 and 3**.

It is recommended that the connector is set to the fully opto-isolated mode.

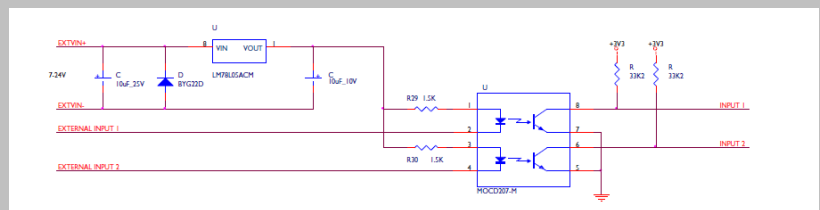
Opto-isolated mode

In this mode, a DC voltage of between 7 and 24 volts is

Key to CPU card interface connectors

required at the EXTVIN+ pin with relation to the EXTVIN– pin. To cause an input to detect an active signal, current must flow from the relevant input pin.

The external device should draw no current to cause an inactive input and at least 5 mA to cause an active input. The opto-isolator drive line contains a 1.5 kOhm resistor to limit the current through the opto-isolator. Therefore, the input pins can be connected directly to the EXTVIN– level to cause an active input.

The voltage level at the external input pin should not be allowed to go below EXTVIN– or above +6 V with respect to EXTVIN–.

Non-isolated mode

To cause an input to detect an active signal in non-isolated mode, the current must flow from the relevant input pin.

The external device should draw no current to cause an inactive input and at least 5 mA to cause an active input. The opto-isolator drive line contains a 1.5 kOhm resistor to limit the current through the opto-isolator.

Therefore, the input pins can be connected directly to a ground pin to cause an active input.

The voltage level at the external input pin should not be allowed to go below ground or above +6 V with respect to ground.

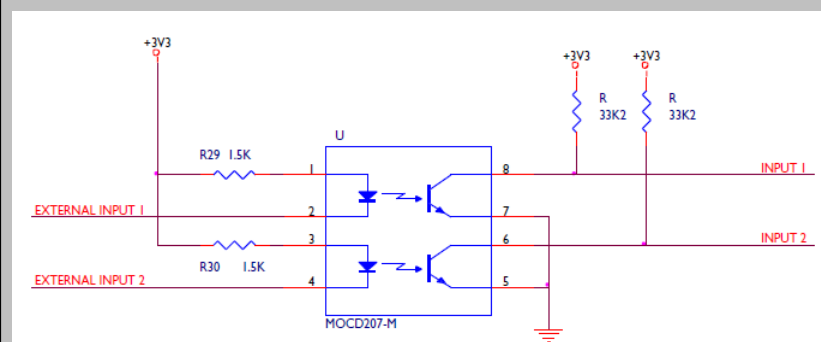

Key to CPU card interface connectors

DB-25 Female Connector

PIN	DESCRIPTION
1	Logic Input 1
2	Logic Input 2
3	Logic Input 3
4	Logic Input 4
5	N/A
6	N/A
7	N/A
8	N/A
9	Ground
10	Ground
11	Ground
12	Ground
13	Ground
14	Logic Input 5
15	Logic Input 6
16	Logic Input 7
17	Logic Input 8
18	N/A
19	N/A
20	N/A
21	N/A
22	Voltage In+
23	Voltage In+
24	Voltage In-
25	Voltage In-



Local Area Network connector (LAN1)

The **LAN1** and **LAN2** connectors have standard Ethernet pin assignments. See **G** below for pin assignments.

The RJ-45 socket labeled **LAN 1** connects a local area network (LAN) to the CPU card through a standard Ethernet connection.

The **green** LED indicates the port is connected and the **amber** LED indicates activity.

Note: If this port is used a ferrite core must be added to the socket end of each cable. A suitable ferrite core is **Würth Elektronik part: 74271132**.

Clear-Com recommends the use of shielded cable.

Key to CPU card interface connectors

**Local Area Network connector (LAN2)**

The **LAN1** and **LAN2** connectors have standard Ethernet pin assignments. The **green** LED indicates the port is connected and the **amber** LED indicates activity.

LAN1 and LAN2 Ethernet RJ-45 Connectors

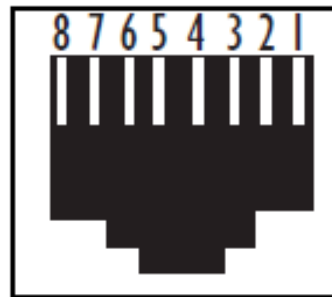

PIN	FUNCTION
1	Transmit data +
2	Transmit data –
3	Receive data +
4	Unused
5	Unused
6	Receive data –
7	Unused
8	Unused

Note: If this port is used a ferrite core must be added to the socket end of each cable. A suitable ferrite core is **Würth Elektronik part: 74271132**.

Key to CPU card interface connectors	
	Clear-Com recommends the use of shielded cable.

4.8.2 DSE1/T1 DSE1/T1 Matrix to Matrix Crossover Cable Connections

For E1 and T1 direct matrix to matrix connections the CAT5 crossover cables should be wired, as shown in the table below:

Matrix 1 Pin	Description	Matrix 2 Pin
1	To	4
2	To	5
3	Not connected	3
4	To	1
5	To	2
6	Not connected	6
7	Not connected	7
8	Not connected	8

4.9 E1/T1 Matrix to Matrix Straight Cable Connections

E1/T1 straight cables may be used to connect E1 or T1 ports to E1 or T1 networks or third party equipment, as shown in the table below:

Matrix 1 Pin	Description	Matrix 2 Pin
1	To	1
2	To	2
3	Not connected	3
4	To	4
5	To	5
6	Not connected	6
7	Not connected	7
8	Not connected	8

4.10 E1 to FreeSpeak II Antenna Straight Cable Connection

Straight CAT5 cables are used to connect an E-QUE card to a FreeSpeak II antenna or splitter.

The E1 pinout for connecting an antenna or splitter is shown in the table below.

Cable wiring is shown in the second table.

Pin	Description
1	Tx+
2	Tx-
3*	DECTSYNC+
4	Rx+
5	Rx-
6*	DECTSYNC-
7*	GND
8*	12V

Matrix 1 Pin	Description	Matrix 2 Pin
1	To	1
2	To	2
3	Not connected	3
4	To	4
5	To	5
6	Not connected	6
7	Not connected	7
8	Not connected	8

5 Using the Eclipse HX-Median

This section describes how to operate the Eclipse HX-Median matrix frame, including its CPU cards and interface cards.

Note: For an overview of the Eclipse HX-Median, see [Overview](#).

5.1 Creating and Storing System Configurations

A **configuration** is a complete set of operating parameters for the system which includes talk and listen paths for each connected intercom device.

Depending on the interface cards and modules installed, the configuration can include more complex features such as paging, call signaling, interrupt foldback (IFB), ISO, groups, automatic DTMF dialing, and routing.

When an external computer is connected to the matrix, you can:

- Retrieve the current configuration information stored in the CPU microprocessor's memory and display the configuration in EHX.
- Apply the current configuration, modify it, or create a new configuration in EHX.

If you create more than one configuration, you can store the unused configurations on the computer's hard disk or on CD-ROM for later use.

Note: The CPU card in the Eclipse HX-Median stores up to four complete configurations. You can apply a configuration directly from the CPU card or from the connected PC.

5.2 Setting the Default IP Address

To reset the CPU LAN ports to their default IP addresses, press and hold the **ENG** and **FULL RESET** buttons on the CPU front card until the card resets.

Note: Do **not** release the **ENG** and **FULL RESET** buttons until the CPU card LED panel shows either an **A** or a **B**.

The **LAN1** Ethernet port is reset to the factory default address of *169.254.0.100* and the second Ethernet port to the *0.0.0.0* (blank) address.

The LAN1 reverts to a link local address of *169.254.0.100* only after trying and failing to acquire an IP address from the network at startup.

The LAN1 defaults to the DHCP mode of operation. This mode of operation is **not** to be used once the frame is operational as it delays the start-up of the frame following any reset.

5.3 Using the CPU Card Ethernet ports

The CPU card Ethernet ports are normally connected to a LAN and used to communicate with clients such as EHX and Dynam-EC. The Ethernet port functionality depends on the IP address setup.

If an IP address of `0.0.0.0` is configured on the second Ethernet port, it will not be used for Tx or Rx. This is the default setup if the default IP address is set as described above.

All matrix to matrix traffic is sent out on both Ethernet ports. This applies to both directed and broadcast packets. All matrix to matrix traffic is also received on both Ethernet ports. If the traffic is transaction related, the second (duplicate) message received is not consumed, but simply dropped.

The matrices listen for client connections on both Ethernet ports. Once the connection is made it is added to the list of connections to service. Broadcast type Tx data is duplicated out on each connection (for example, HCI connection to the matrix from 3rd party applications).

The EHX Server makes a connection on either the main or backup Ethernet port of each system in the linked set. If both are up, this will default to the primary port. In the event that connection is lost to the currently active port on a matrix the EHX server will swap over to using the other Ethernet port. If this connection is lost only on one matrix in a linked set, the others will not be affected.

5.3.1 Configuration Restrictions for Ethernet ports

The network ID on the first Ethernet port must be different to that of the second port.

The network ID is defined by the IP address and the network mask for the port. For example a network address of `172.16.2.1` and a mask of `255.255.0.0` gives a network ID of `172.16`.

Therefore, in this scheme the second port could not have an IP address, starting with `172.16`.

If the network mask is extended to `255.255.255.0` the network ID becomes `172.16.2` so the second port could have an address of `172.16.3.1` and a mask of `255.255.255.0` giving a network ID of `172.16.3` for the second port.

If both Ethernet ports are set up with the same network ID this condition results in data loss on one or both of the Ethernet ports.

Note: *Ethernet redundancy and the use of a default gateway is **not** supported. An IP address and gateway combination on an Ethernet port means that all Tx traffic to any address is possible on the port. Traffic that actually matches the other Ethernet port can therefore be sent out on the **wrong** port.*

5.4 CPU Card Fail-Safes

The CPU card's non-volatile memory stores all information about the current operating configuration and the three additional configurations, allowing the system to restore itself automatically after:



- A power failure.
- The replacement of a port card.
- The replacement of a panel.

An Eclipse HX-Median system operates with either one or two CPU cards.

When a second card is installed, that card stores the four configurations in its RAM as a backup to the main card. If the main card is removed or becomes non-operational for any reason, the system will automatically switch to the second card as backup.

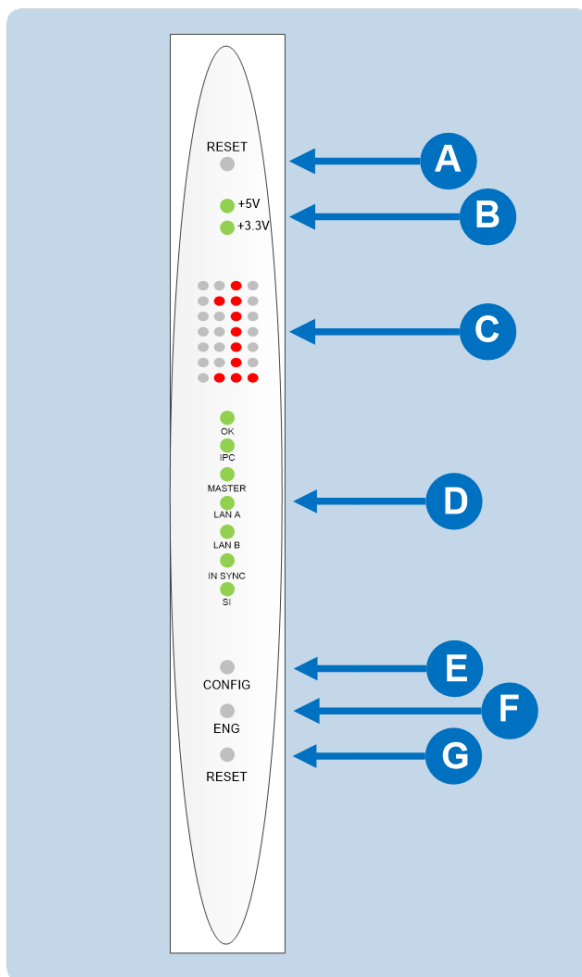
5.5 CPU Card Lights and Controls



Key to CPU card lights and controls	
Feature	Description
	<p>RESET button</p> <p>Pressing the RESET button causes the CPU card to stop its current activity and to restart. The same configuration that was active before the system was reset will be active after the system was reset.</p> <p>During the reset, configuration information reloads to the card's operational memory from its non-volatile memory and the card starts running again from the beginning.</p> <p>The reset button is slightly recessed from the front panel to prevent it from being accidentally pressed. A tool such as a bent paper clip is needed to press this button.</p>
	<p>Power supply lights</p> <p>+ 5-Volt light</p> <p>When lit, the +5V light indicates that the matrix's +5-volt power supply is actively supplying power to the CPU card.</p> <p>+3.3-Volt light</p> <p>When lit, the +3.3V light indicates that the matrix's +3.3-volt power supply is actively supplying power to the CPU card.</p>

Key to CPU card lights and controls



Dot Matrix lights

The rectangular array of lights just below the power-supply lights displays a number (either **1, 2, 3, or 4**) to indicate the currently selected configuration. The EHX configuration software controls these lights.

In addition these lights will indicate if the following errors are detected at startup:

NVRAM error

When the NVRAM is found to be corrupt at start up the config card will output the string **CHECK BATTERY**.

Non matching slave firmware

The Eclipse HX system only supports master and slave backup between two cards that are running the same version of firmware. In the case when a non matching slave card firmware version is detected the **NON-MATCHING SLAVE_FIRMWARE** message is displayed by the master CPU card.

Hardware version verification

When an older, unsupported version of the MVX or E-QUE FPGA is detected, the **EQUE FPGA VERSION UNSUPPORTED** message is displayed by the master CPU card.

Note: *The dot matrix lights will also display system information when the **ENG** button is pressed on the master CPU card. This is described below in the section on the **ENG** button.*

Key to CPU card lights and controls



Status lights

OK Light

When flashing, the OK light indicates that the CPU card is successfully communicating with the EHX configuration software.

IPC (Interprocessor Communication) Light

The “interprocessor communication” (IPC) light only operates when there are two CPU cards in the matrix. When lit, the light indicates that the two CPU cards are exchanging information.

Master Light

An Eclipse HX-Median system can have two CPU cards, although the system will operate with only one. If the primary card becomes unavailable for any reason, the second card can serve as backup while the primary card is repaired or replaced.

The “master” light illuminates on whichever CPU card is currently serving as master. If there is a backup CPU card in the matrix, its “master” light will not illuminate if the primary card is acting as master.

LAN A Light

When a local area network (LAN) is connected to the matrix’s LAN A port, the CPU card’s LAN A LED lights to indicate a connection to the Eclipse Configuration Software LAN A port.

LAN B Light

When a second local area network is connected to the matrix’s “LAN B” port, the CPU card’s “LAN B” LED lights to indicate a connection to the Eclipse Configuration Software (EHX) LAN B port.

Sync Light

When multiple Eclipse HX matrices are connected together the “sync” light illuminates to indicate that the matrices are connected and synchronized.

SI Light

The SI light flashes to indicate communications activity.

Key to CPU card lights and controls



Configuration [CONFIG] button

The CPU card can hold four complete system configurations in its operational memory. When the **CONFIG** button is pressed the number of the currently active configuration (either **1**, **2**, **3**, or **4**) appears in the dot-matrix display.

Each time the button is subsequently pressed the next configuration number in the series appears in the dot-matrix display. The numbers cycle forward until all of the choices have been displayed, then start again at **1**.

When a non-active configuration's number appears in the display, it flashes to indicate its non-active status. When an active configuration's number (either **1**, **2**, **3**, or **4**) appears in the display, it illuminates solidly (without flashing) to indicate that it is the active configuration.

To select one of the four configurations from the CPU card:

1. On the front of the CPU card, repeatedly press the **CONFIG** button until the number of the desired configuration (**1,2,3**, or **4**) is shown by the dot matrix display.
2. When the desired number is displayed, press and hold the **CONFIG** button until the display stops flashing. This should take about three seconds. The selected configuration has now been activated.

Note: The CPU card includes an additional, embedded configuration, which can be activated for fast fault checking following a system upgrade or field install. For more information, see [Using the Embedded Configuration](#)

Key to CPU card lights and controls



Engineering [ENG] button

This button is used to reset the system to the default IP address (169.254.0.100) with DHCP enabled and to display system information on the LED dot matrix (see [Setting the Default IP Address](#))

System status

If the **ENG** button only on the master CPU is pressed the following system information will be displayed on the LED dot matrix:

- **Eclipse HX release.** For example, v7.0 at 7.0.
- **Eclipse IP address.** IP address of the LAN 1 port, for example *169.254.000.100*.
*Note: If this address was not statically allocated, but instead was allocated via DHCP server this will be pre-pended by **DHCP ENABLED***
- **System number.** This is only output if the rack is part of a linked set. It is the system number of the node within the linked set (for example, **SYSTEM 3**).
- **Software version number.** Version number of the config card software (for example, **RACK 1.0.2.1**).
- **Hardware serial number.** For example, **SERIAL 2251**, in the case where the HW serial number is 2251.

Key to CPU card lights and controls



Full Reset button

When a full reset is performed, **all** cards in the matrix reset, regardless of any system preferences in the program software. Non-volatile memory is cleared.

To perform a full reset:

1. Press and hold the CPU card's lower **RESET** button (the **Full reset** button).
2. Simultaneously press and release the CPU card's upper **RESET** button.
3. Continue holding the CPU card's lower **RESET** button for two seconds. The CPU card then performs a full reset.

The same configuration that was active before the system was reset will be active after reset.

When the cards and connected audio devices reset, they momentarily stop their current activity and restart. During this process configuration information is downloaded to the cards and audio devices from the CPU card's non-volatile RAM.

Note: *Under normal operating conditions it is not necessary to perform a full reset. Technical personnel might perform a full reset if they believe that the CPU card is operating incorrectly as a result of corruption of the microprocessor's internal data or instruction sequence.*

5.5.1 Using the Embedded Configuration

In addition to the four EHX configurations that can be stored on the card, the CPU card also includes an embedded configuration. The embedded configuration is designed for fast fault checking following a system upgrade or field install (for example, checking hardware connections with user panels and interface cards).

Note: *The embedded configuration may also be used as a back-up configuration, in the very rare event that a system error renders the other configurations unusable.*

To activate the embedded configuration:

1. On the front of the CPU card, press and hold the **CONFIG** and the **ENG** buttons.
2. Simultaneously, reset the CPU card by pressing and holding the CPU card's lower **RESET** button (the **Full reset** button).

Note: *A tool, such as a pin, is used to press and hold the RESET button.*

- Continue holding the **CONFIG**, **ENG** and **RESET** buttons until the CPU card's dot matrix display displays **0**. It may take 1 - 2 seconds before **0** is displayed.



The embedded configuration has now been activated.

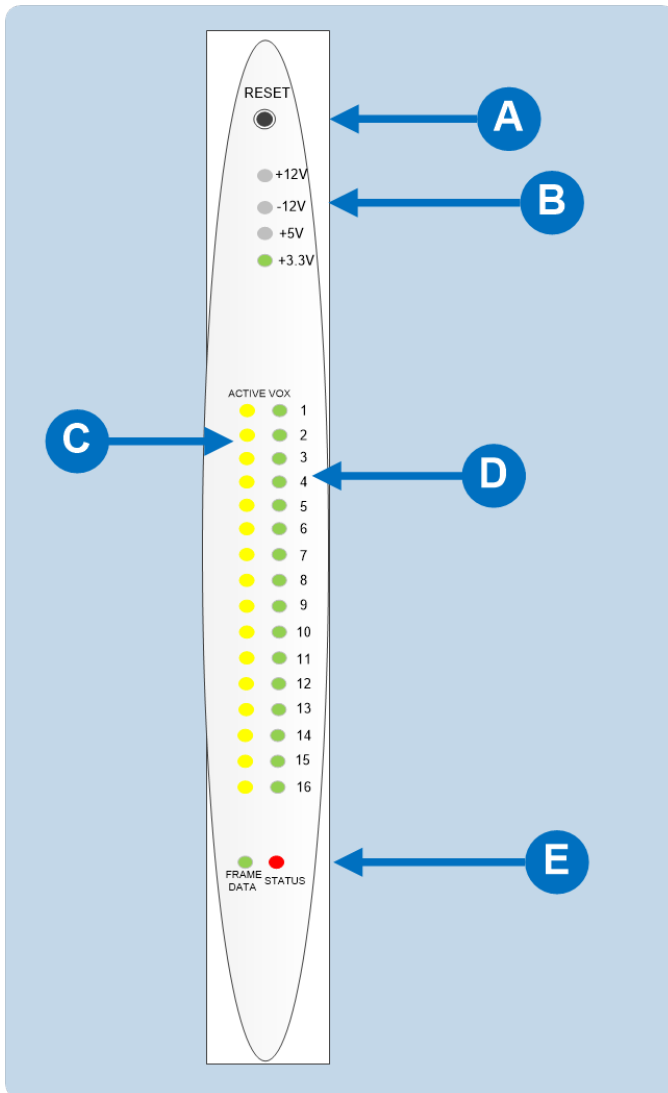

To deactivate the embedded configuration, perform a CPU card reset.

The configuration (**1, 2, 3 or 4**) that was previously active on the CPU card replaces the embedded configuration as the active configuration.

5.6 MVX-A16 Analog Card Front-Panel Lights and Controls



Key to MVX-A16 analog card lights and controls	
Feature	Description
	<p>RESET button</p> <p>Pressing the RESET button causes the card and all connected audio devices to momentarily stop their current activity and to restart. The card's "frame data" light goes off when the reset starts and comes back on when the reset is complete.</p> <p>During the reset, configuration information downloads to the card and its connected audio devices from the CPU card. If the entire system is operating except for one port card, or one or more panels connected to the card, press the reset button for that card only.</p> <p>Tip: The reset button is slightly recessed from the front panel to prevent it from being accidentally pressed. A tool such as a bent paper clip is required to press this button.</p>
	<p>Power supply lights</p> <p>+12-Volt and -12-Volt Power Supply Lights</p> <p>The matrix's +12-volt and -12-volt power supplies provide electric current to these two green lights. When lit, these lights indicate that the matrix's +12-volt and -12-volt power supplies are present and supplying electric current to the card.</p> <p>+5-Volt Power Supply Light</p> <p>The matrix's +5-volt power supply provides electric current to this green light. When lit, the light indicates that the +5 supply is present and supplying electric current to the card.</p> <p>+3.3-Volt Power Supply Light</p> <p>The matrix's +3.3-volt power supply provides electric current to this green light. When lit, the light indicates that the +3.3-volt supply is present and supplying electric current to the card.</p>
	<p>Active Lights</p> <p>When lit, an active light indicates successful communication between the port card and a connected device such as an intercom panel or interface.</p> <p>Each of the port card's 16 yellow active lights corresponds to one of 16 rear-panel connectors or "ports" to which audio devices can be connected.</p>

Key to MVX-A16 analog card lights and controls	
	<p>VOX Lights</p> <p>When lit a VOX light indicates that the audio level on a connected device, such as an intercom panel or interface, has exceeded a preset threshold. The threshold audio level is set through the EHX application.</p> <p>Each of the port card's 16 green VOX lights corresponds to one of 16 rear-panel connectors or "ports" to which audio devices (intercom panels or interfaces) can be connected.</p>
	<p>Frame Data Light</p> <p>The green frame data light flashes (1: 1 0.5Hz) to indicate successful communication between the port card and the CPU card.</p> <p>Status Light</p> <p>The red status light illuminates to indicate a failure in communication between the port card and the CPU card.</p>

5.7 Diagnosing Power Supply Problems

The Eclipse HX-Median has two Euro Cassette power supply units. One power supply unit can power an entire matrix. The second unit provides a backup in case of an equipment failure.

Eclipse HX-Median matrices may be fitted with **XP** (part 740101Z) or **Power-One** (part 720379Z) power supply units, depending on the date of manufacture. Each cassette has two status lights located on the power supply unit in the upper left corner.

The **green** light stays on continuously to indicate that the unit is receiving appropriate power. The **amber** (XP unit) or **red** (Power-One) light goes on when a DC output or AC input falls too low.

	<p>The different types of power supply units must not be mixed in an Eclipse HX-Omega matrix; if one of the pair of power supplies is replaced it must be replaced with the same type of power supply unit. If this is not possible both power supplies must be replaced with power supply units of the same type.</p> <p>Power-One/Bel Fusepower supplies are identified by the part number on the front of the unit; XP units do not have a part number on the front of the unit.</p>
---	--

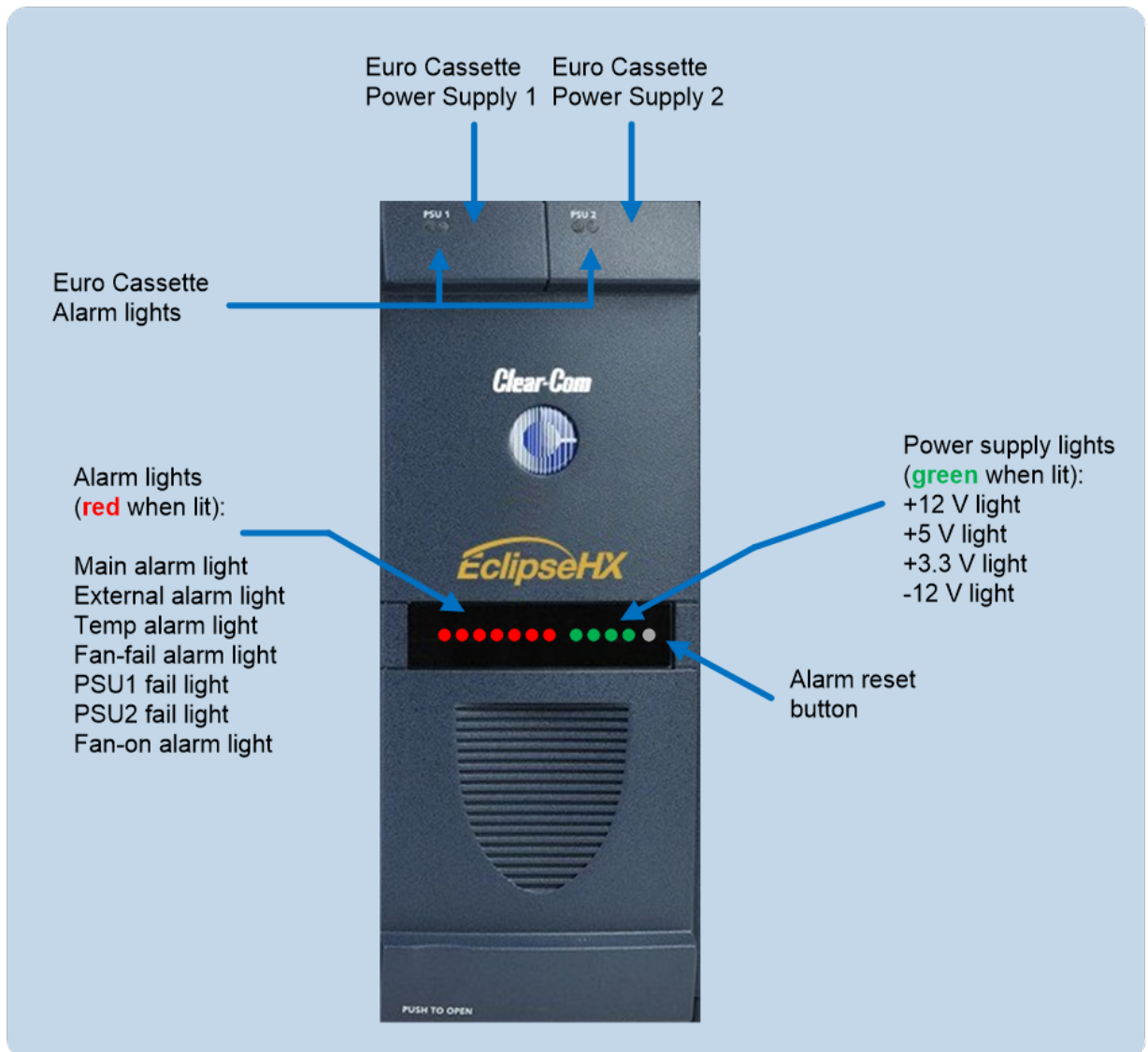

The front panel alarm lights, power supply lights, and reset button are shown in Figure 24.

An alarm source triggers the **red** main alarm light and also one of the additional six **red** alarm lights, allowing the system operator to identify or correct alarm conditions before they affect the operation of the matrix.

Each of the four **green power supply lights** stays on continuously to show that the power supplies are receiving sufficient AC current. When one of these lights switches off, the power supplies must be replaced or repaired.

Under normal operating conditions, the **red front-panel alarm lights** stay off, while the **green power supply lights** stay on continuously.

Notes: *The XP type power supplies (part 740101Z) may need to be adjusted if E-QUE, E-FIB, IVC-32 or LMC-64 interface cards are installed. For more information, see the **Eclipse HX Upgrade Guide**.*

*Power-One/Bel Fusepower supply units (part 720379Z) should **not** be adjusted.*

5.7.1 Conditions that Cause an Alarm

The following conditions trigger an alarm:

- If any of the voltages produced by the first power supply unit fall below normal levels.
- If any of the voltages produced by the second power supply unit fall below normal levels.
- If an internal matrix alarm condition activates a matrix relay to turn on an external alarm.
- If either of the CPU cards is removed from the matrix.
- If either of the matrix's two cooling fans stop operating.

5.7.2 Main Alarm Light

An alarm condition triggers the following events:

- The **red** main alarm light flashes.
- The matrix's internal alarm buzzer sounds.

Any installed alarm relay outputs switch to active (the normally open contact closes and the normally closed contact opens). When the alarm relay activates, it can cause an externally connected device like a light or buzzer to switch on.

One of the six **auxiliary red alarm lights** may go on, to more precisely indicate the source of the alarm condition (see [Auxiliary Alarm Lights](#)).

5.7.3 Alarm Reset Button

When the alarm reset button is pressed the following events take place, even if the alarm condition has not been corrected:

- The internal audible alarm buzzer stops buzzing.
- Any wired relay contacts return to their inactive state. If these relays are connected to external alarm lights or alarm buzzers, those lights or buzzers shut off.
- If the original alarm condition still exists, the red main alarm light on the matrix's front panel continues to flash. The red main alarm light only stops flashing when all original sources triggering the alarm are corrected.
- If a new alarm condition or conditions occur before the original alarm conditions are corrected, the internal buzzer and relay contacts will not reactivate. They will only reactivate after all original alarm conditions are corrected.

5.7.4 Auxiliary Alarm Lights

When an alarm condition occurs, any of the six auxiliary red alarm lights may switch on, in addition to the main alarm light, to help diagnose the alarm condition. The following sections

describe the six auxiliary alarm lights.

External alarm (EXT ALARM)

The **red** external alarm (labeled **EXT ALARM**) light switches on to indicate that an alarm condition has triggered the built-in relay outputs to turn on any externally installed alarms such as lights or bells.

The external alarm is connected to the matrix through the 9-pin D-type connector on the matrix's rear panel labeled **Alarm I/O**.

Temp alarm (Temperature alarm)

The **red Temp (temperature) alarm** light switches on to indicate one or both of the following:

- The active CPU card has detected a temperature in the matrix above a threshold.
- One of two CPU cards has been removed from the matrix.

Note: *This feature only operates if there are two CPU cards installed in the matrix. If there is only one CPU card, the Temp alarm light does not switch on if the card is removed.*

Fan-fail alarm

The **red fan-fail alarm light** illuminates when **either** fan in the power-supply module stops rotating correctly.

PSU1 Fail

When the first power supply unit is operating correctly, the **red PSU1 light** stays off, while the four **green power supply lights** (+12V, +5V, +3.3V, -12V) stay on continuously.

If a DC output or AC input to the first power supply drops too low, the **red PSU1 light** switches on. The **amber** (XP) or **red** (Power-One) light on the power supply unit itself also switches on to indicate the same condition. One of the green power supply lights may then switch off to help indicate the source of the trouble.

Note: *The PSU1 fail light only works if the first power supply is plugged into the matrix's midplane from inside the matrix.*

A temperature sensor inside the power supply senses if the power supply overheats, and switches on the second matrix cooling fan. The **red Temp light** switches on to indicate that the active CPU card, not a power supply, has overheated.

PSU2 Fail

When the second power supply unit is operating correctly, the **red PSU2 light** stays off, while the four **green power supply lights** (+12V, +5V, +3.3V, -12V) stay on continuously.

If a DC output or AC input to the second power supply drops too low, the **red PSU2 light** switches on. The **amber** (XP) or **red** (Power-One) light on the power supply unit itself also

switches on to indicate the same condition. One of the green power supply lights may then switch off to help indicate the source of the trouble.

Note: *The PSU2 fail light only works if the first power supply is plugged into the matrix's midplane from inside the matrix.*

A temperature sensor inside the power supply senses if the power supply overheats, and switches on the second matrix cooling fan. The **red Temp light** switches on to indicate that the active CPU card, not a power supply, has overheated.

Fan-On alarm light

Two fans deliver forced air cooling to the matrix's power supplies. The primary fan runs continuously. If a temperature exceeding a threshold is detected in a power supply and extra cooling is required, a second fan switches on to increase the air flow.

The **fan-on alarm light** illuminates **red** to indicate that the second fan is on.

5.7.5 Power Supply Lights

The **green power-supply lights** illuminate to indicate that the power supplies are receiving +12 V, -12 V, +5 V, and 3.3 V power.

5.8 Connecting the Matrix Frame

Note: *For detailed information about connecting the matrix to panels, interfaces and other devices, see [Installing the Eclipse HX-Median](#)*

The Eclipse HX-Median matrix frame connects to devices such as the external computer that runs the EHX configuration software, panels, interfaces, and other matrices through its rear-panel hardware connectors, often called **ports**.

These connectors are housed in modular removable panels. Each panel is associated with a corresponding front-panel circuit card.

5.8.1 Eclipse HX-Median Rear Connector Panels

There are six types of rear-connector panels:

Panel	Description
CPU card	A CPU-card rear panel holds the various connectors associated with the CPU card, such as the RS-232 connector for the configuration computer.
Analog port card (MVX-A16)	Analog port-card rear panel holds the sixteen RJ-45 connectors associated with its corresponding analog port-card front panel. User panels and interface modules connect to the matrix through this rear-connector panel.
E-MADI64 card	An E-MADI64 rear card comprises a MADI fiber connector, MADI input and output coaxial cable connectors, and a coaxial Video / Word clock input.
E-FIB fiber card	An E-FIB fiber card provides two ports to connect fiber network cables.
E-QUE card	An E-QUE card provides eight RJ-45 ports for connection to wireless equipment and three RJ-45 ports for DECT sync and LAN connections.
IVC-32 card	An IVC-32 card provides a RJ-45 port for connection to an IP network. No other ports are used.
LMC-64 card	An LMC-64 card provides a RJ-45 port for connection to an IP network. No other ports are used.
E-IPA card	An E-IPA card provides a four RJ-45 and two SFP ports for connection to IP networks as configured in EHX. When used in E1 mode two SFP ports are active for connection to FreeSpeak II Splitters. The card includes a USB-C port for service use.

Note: A **blank panel** covers an unused slot in the matrix.

5.8.2 Connecting the CPU Card

The rear-connector panel associated with the CPU card holds seven connectors.

Note: For a detailed description of each connector, including wiring and pinout information, see [CPU Card Interface Connectors on page 41](#).

A matrix only requires one rear-panel CPU card, because whichever of the two front-installed CPU cards is acting as master will work in conjunction with this card. All other front cards, however, require their own rear-connector panel.

Note: For detailed information about connecting the matrix to panels, interfaces and other devices, see [Installing the Eclipse HX-Median on page 28](#).

5.8.3 Connecting Interface Cards

Each rear-connector panel associated with an **MVX-A16** (analog) interface card holds the sixteen RJ-45 connectors that connect the matrix to user panels, interface modules and other intercom devices. Each front-installed MVX-A16 port card requires a corresponding rear-connector panel. Blank panels cover unused slots.

Each port on the matrix can be located and identified by using the rear-panel numbering grid:

- Port rows are numbered 1 through 16.
- Port columns are numbered 1 through 7.
- CPU card columns are numbered P1 and P2. (One rear panel operates with either of the currently active CPU cards).

Notes: A port can be identified precisely by identifying its card number and port number on the card. For example, the ports on the first card are designated 1-1, 1-2, 1-3, 1-4, and so on; the ports on the second card are designated 2-1, 2-2, 2-3, 2-4, and so on.

See also [Analog Port Numbering on page 35](#).

Each rear connector panel associated with an **E-QUE** interface holds eleven RJ-45 ports:

- Eight ports for connection to wireless equipment.
- Two ports for DECT sync.
- One port for LAN connections.

Each rear connector panel associated with an **IVC-32** interface holds eleven RJ-45 ports:

- Eight ports for connection to E1/T1 equipment (not used).
- Two ports for DECT sync (not used).
- One port for LAN connections, used for IP-enabled V-Series panels and Concert soft-panels.

Each rear connector panel associated with an **LMC-64** interface holds eleven RJ-45 ports:

- Eight ports for connection to E1/T1 equipment (not used).
- Two ports for DECT sync (not used).
- One port for LAN interface used for broadcasting audio levels to Dynam-EC clients.

Each rear connector panel associated with an E-FIB interface holds two fiber ports (TXVRA and TXVRB).

Note: For detailed information about connecting the matrix to user panels, interface modules and other devices, see [Installing the Eclipse HX-Median on page 28](#).

5.9 Connecting 4-Wire

When referring to intercoms, a four-wire circuit describes an intercom connection (I/O) where there are four wires (two paths) and the paths are different for talk and listen.

Analog or four-wire circuits use two pairs for balanced line-level audio signals, one for input and the other for output, using four wires in total.

Note: A four-wire audio circuit is further defined by the attribute that the two paths can be used for unassociated signals. This means that the source input is not always associated with or routed to the destination output. This is commonly known as a four-wire split or split port. At the time of writing, a split port is only available on Eclipse-HX Digital Matrix products.

Note: To minimize noise and meet regulatory requirements, use screened (shielded) cable when connecting 4-wire ports.

5.9.1 Connecting Audio - Non-Clear-Com to Clear-Com (4-Wire)

All Clear-Com four-wire audio ports are analog format line level (0 dBu nominal / 18 dBu max).

When connecting non-Clear-Com equipment to a Clear-Com device, the following is the correct default pinout of the four-wire port (RJ45) for input and output.

Note: Except the Eclipse MVX-A16 interface card (input 3 & 6, output 4 & 5).

Pin	Use	
1	n/a	<p>RJ45 Pinout T-568B</p> <p>1. White Orange 5. White Blue 2. Orange 6. Green 3. White Green 7. White Brown 4. Blue 8. Brown</p>
2	n/a	
3	Audio Out +	
4	Audio In +	
5	Audio In -	
6	Audio Out -	
7	n/a	
8	n/a	

Pin	Use	
1	n/a	
2	n/a	
3	Audio Out +	
4	Audio In +	
5	Audio In -	
6	Audio Out -	
7	n/a	
8	n/a	

Note: Always read your 3rd party manual before connecting to Clear-Com.

Note: The above diagram illustrates the default pinout mode for Clear-Com RJ45 : 4-wire-X. See **Port Function** for details.

XLR Breakout Cable Termination to RJ45 4-Wire

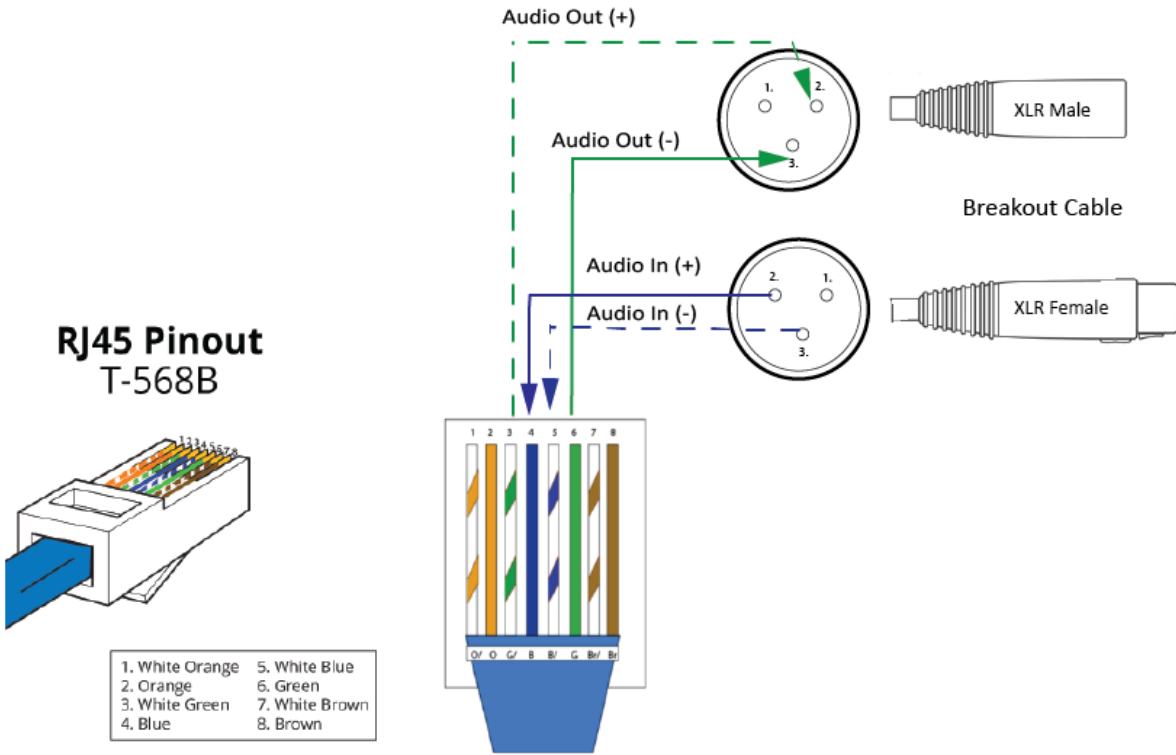

A breakout cable is supplied with the Arcadia and Edge base stations. For other connections you need to make your own cable.

The cable is available to buy from Clear-Com:

CAB-RJ45-PGM-SA - Four-Wire Analog Audio Splitter Cable - PGM/SA with RJ45 to 3-pin XLR-F & 3-pin XLR-M.

XLR Panel Termination (Non-Clear-Com) to RJ45 4-Wire

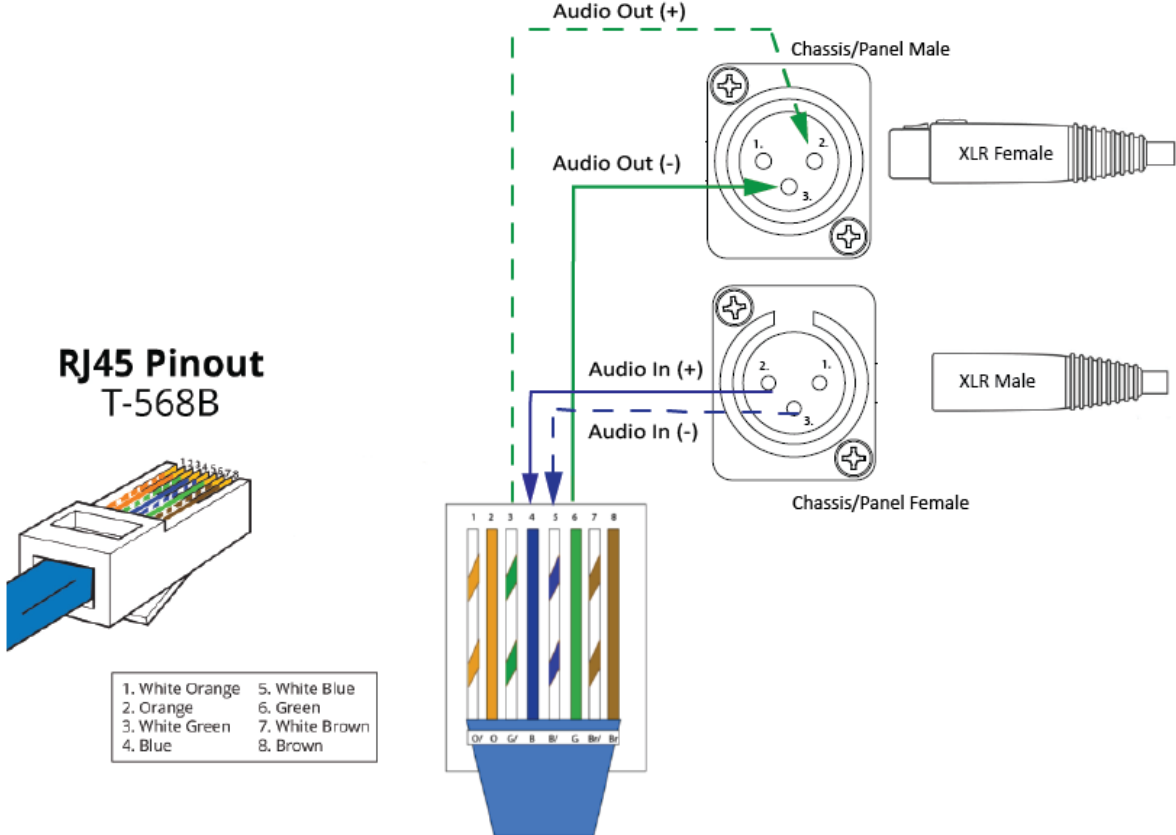

5.9.2 Port Function (4-Wire Toggle)

Some 4-wire RJ45 connectors on Clear-Com products include a software switch that toggles audio I/O pin configuration on the connectors according to the device you are connecting to. This means that when connecting to Clear-Com devices, a cross-over cable is not necessary.

Clear-Com devices can have the following RJ45 4-wire pinouts:

- Clear-Com **4-Wire (To Panel)** on older systems)
- Clear-Com **4-Wire -X(To Matrix)** on older systems)
- Configurable, (either pinout is possible, according to the **Port Function** toggle switch).

To set the **Port Function** toggle, go to **Port Options** in the CCM or the device front panel menu system.

RJ45 Pinouts (Port Function Toggle)

Pin No	4-wire (To Panel)	4-wire-X (default) (To Matrix)
1	Data in +	Data out +
2	Data in -	Data out -
3	Audio in +	Audio out +
4	Audio out +	Audio in +
5	Audio out -	Audio in -
6	Audio in -	Audio out -
7	Data out +	Data in +
8	Data out -	Data in -

Clear-Com RJ45 4-Wire Pinout type by Device

Device	Clear-Com RJ45 pinout type on this device (Port Function)
FreeSpeak II	4-wire-X (fixed)
HelixNet HLI-4W2	4-wire-X (fixed)
HME DX200/DX210/DX410	4-wire-X (fixed)
Eclipse MVX-A16	4-wire (fixed)
FreeSpeak II Base II	Configurable. Default setting is 4-wire-X
FreeSpeak Edge BaseArcadia Central Station	Configurable. Default setting is 4-wire-X .
LQ Series	Configurable. Default setting is 4-wire-X

5.9.3 Connecting 4-Wire Clear-Com to Clear-Com

When connecting Clear-Com to Clear-Com, one device must be in **4-wire** mode and one device must be in **4-wire-X** mode if you wish to use a straight-through cable.

Example: Eclipse-HX MVX-A16-HX card to LQ 4W2

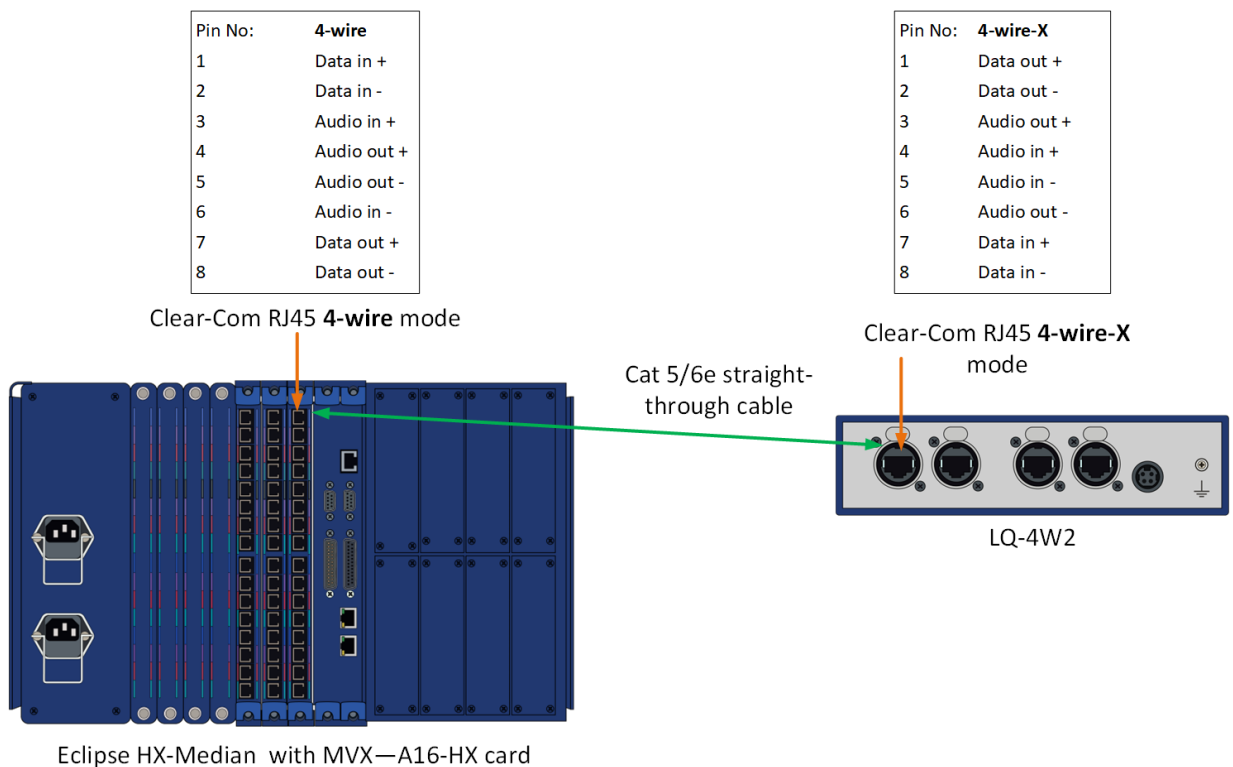

Example: Eclipse-HX MVX-A16-HX card to HelixNet Main Station

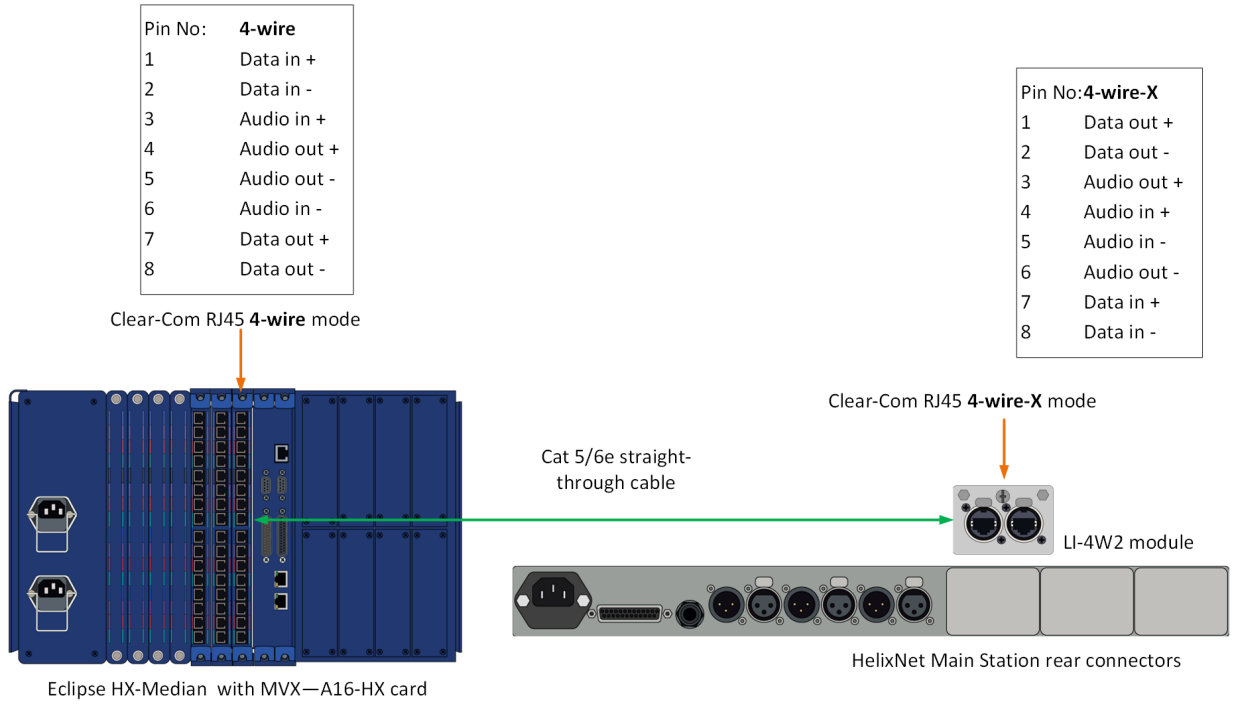

6

E-MADI64 Card

This section describes the **E-MADI64 card**.

The E-MADI64 is a **MADI (Multichannel Audio Digital Interface)** card, providing up to 64 duplex channels of AES10 digital audio over a coaxial cable or fiber pair between compatible devices. The card supports both direct and trunk connections.

You can limit the quantity of channels to 32, 56 or 64 channels in EHX.

The E-MADI card supports up to 32 V-Series Panels. See [V-Series Panels on E-MADI \(Multichannel Audio Digital Interface\)](#)

Each E-MADI64 card set comprises:

- A front card with pin reset and various status indicators (including channel quantity, sample rate, power and diagnostic (active and error) indicators).
- A rear card with a MADI multimode fiber connector, MADI input and output coaxial cable connectors, and a coaxial Video / Word clock input.

The standard maximum cable length is 2km, using fiber cable, or 50m using coaxial cable. Up to 15km is available to special order, using the single mode fiber option.



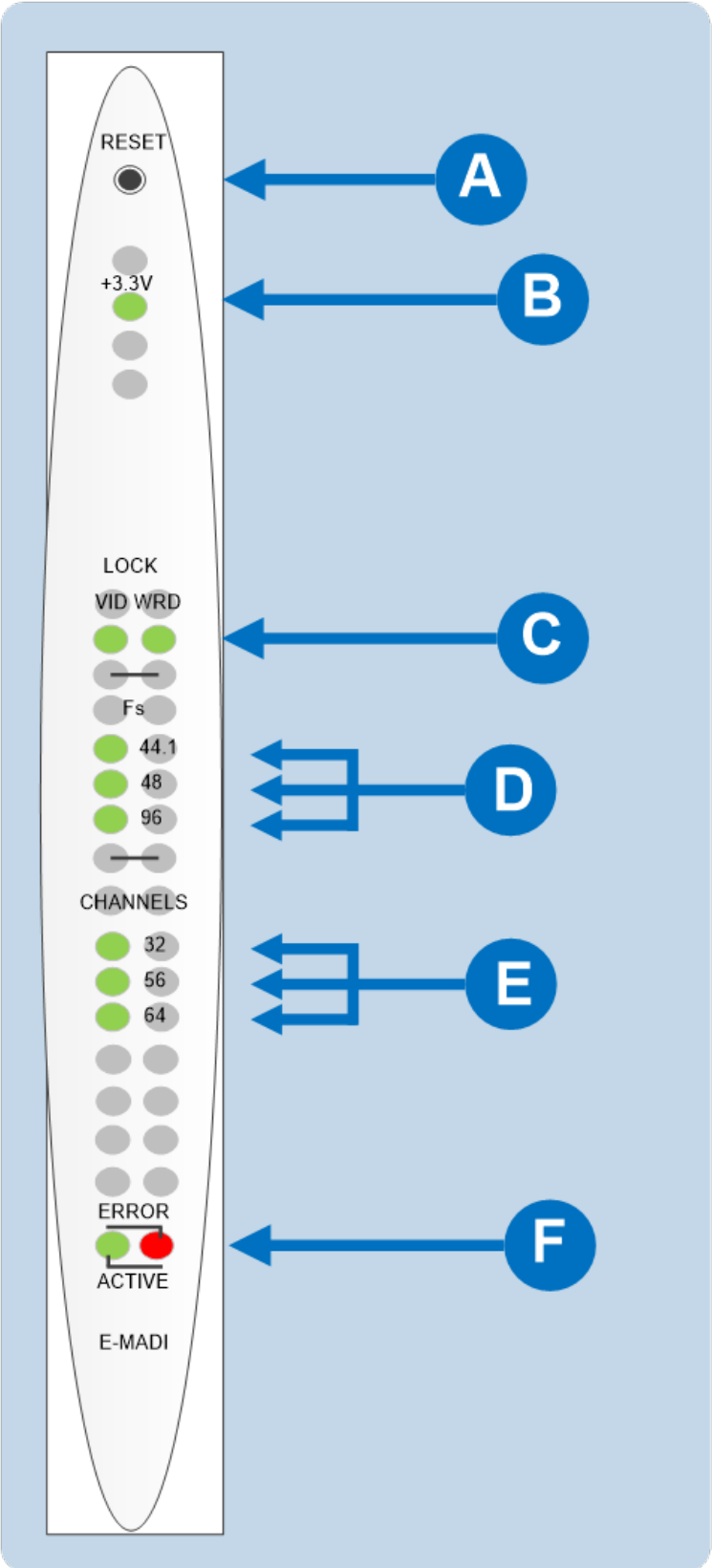

Note: *All MADI channels have standard EHX settings, including VOX and in-use tally.*



6.1 E-MADI64 Front Panel Lights and Controls



Notes: Figure 25 shows an **unconfigured** E-MADI64 card, when **all** lights are lit to indicate their location.

On a card with a clock source and MADI connections (where the received MADI signal matches the card set up), the following lights are lit: the **Lock source** LED, the **Sample rate (Fs)** LED, the Channels LED and the Active LED. The **Error** LED is also lit when there is no clock source or MADI input.

Key to E-MADI64 front panel lights and controls	
Feature	Description
	<p>Reset button</p> <p>Pressing the Reset button causes the card and all links to momentarily stop their current activity and to restart. The flashing green Active light goes off when the reset starts and comes back on when the reset is complete.</p> <p>During the reset, configuration information downloads to the card and its connected matrices from the CPU card. If the entire system is operating except for one E-MADI64 card, press the reset button for that card only.</p> <p>Tip: The reset button is slightly recessed from the front panel to prevent it from being accidentally pressed. A tool such as a bent paper clip is needed to press this button.</p>
	<p>+3.3-Volt Power Supply LED</p> <p>The matrix frame's +3.3-volt power supply provides electric current to this green light. When lit, the light indicates that the +3.3-volt supply is present and supplying electric current to the card.</p>
	<p>Lock source</p> <p>A green light indicates that the E-MADI64 card has locked to the clock source (either video (VID) or Word Clock (WRD)).</p>
	<p>Sample rate or Sf (Sampling frequency)</p> <p>A green LED indicates the current sampling rate of the MADI channels. The sample rate is determined in EHX when a video sync is used, or automatically detected from the clock source when a Word clock is used.</p> <p>Note: <i>If the quantity of channels is 32, the sampling rate is either 44.1KHz, 48KHz or 96KHz. If the quantity of channels is either 56 or 64, the sample rate is either 44.1KHz or 48KHz.</i></p> <p>The Sample rate LED on the front of the E-MADI64 will oscillate between two sample rates when the received sample rate differs from the transmitted sample rate.</p>

Key to E-MADI64 front panel lights and controls	
	<p>Channels</p> <p>A green LED indicates the quantity of MADl channels. The number of channels is determined in EHX. You can select from 32, 56 or 64 full duplex channels of digital audio.</p> <p><i>Note: Channel LEDs on the front of the E-MADI card will oscillate between two channel numbers when the number of channels received differs from the number of channels set in EHX.</i></p>
	<p>Diagnostics</p> <p>Active LED</p> <p>The Active (frame data) LED flashes green (1:1 at 0.5Hz) to indicate successful communication between the E-MADI64 master card and the CPU card.</p> <p>Error LED</p> <p>The Error (status) LED is lit solid red when there is no clock source or MADl input.</p> <p><i>Note: During boot up, the Active and Error LEDs flash rapidly until the boot sequence is completed.</i></p>



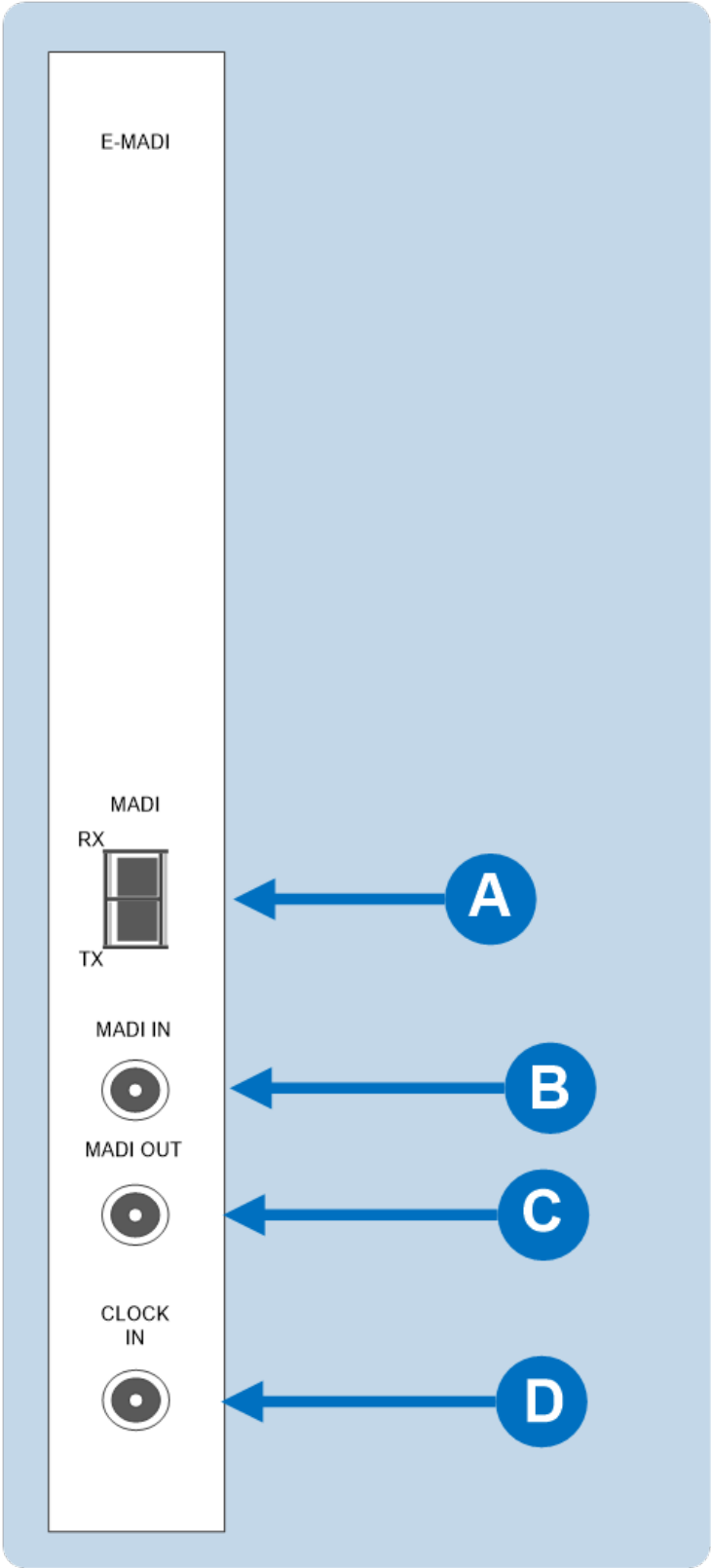

6.2 E-MADI64 Rear Panel Connectors



Warning: Eye Safety

This LED based single mode transceiver is a **Class 1 LED product**. It complies with IEC 60825-1/A2:2001 and FDA performance standards for laser products (21 CFR 1040.10 and 1040.11) except for deviations pursuant to Laser Notice 50, dated July 26, 2001.

Normally a protective plug is fitted to the fiber connector to protect the connector from damage or the entry of foreign materials. The protective plug should only be removed in order to fit the fiber optic cable. Replace the plug when the cable is unplugged.

Key to E-MADI64 rear panel connectors	
Feature	Description
	<p>MADI Fiber connector (Tx and Rx)</p> <p>The connector is a fiber (MM) SFP Duplex LC removable transceiver module</p>
	<p>MADI IN coaxial connector</p>
	<p>MADI OUT coaxial connector</p>
	<p>Video / Word clock coaxial connector</p> <p>The clock source is either NTSC/PAL Black and burst, Tri Level HD video sync or AES Word Clock.</p>

6.3 MADI Channels

The E-MADI64 card can route up to 64 MADI channels of audio.

***Note:** The channel modes for the E-MADI64 are 32, 56 and 64. For more information, see the table in the next section.*

Each MADI audio channel:

- Carries one (or a mixture of) any of the 512 Eclipse HX-Median backplane timeslots.
- Is 24 bits in length.

You can configure the input and output gain for each MADI audio channel in EHX and / or Dynam-EC software. The configurable range for MADI audio channels is **-72dB to +18dB**.

6.3.1 MADI Channel Labeling

The 4-character channel ID for each MADI input channel is taken from the provided embedded data bits. The channel ID for each MADI output channel can be re-labeled in EHX, or alternatively replaced with Dynam-EC alias labels. This means that Eclipse HX user panels can automatically show the MADI channel ID (or Alias as supplied from Dynam-EC).

The channel labeling options in EHX are therefore:

- To use the 4-character, 3rd party ID, provided from the input channel.
- To use the Dynam-EC Alias.
- To disable the ID and use the EHX port name.

6.4 Setting Up the E-MADI64 Card

To set up the E-MADI card:

1. With the Eclipse HX-Median powered off, insert the E-MADI front and rear cards into the frame.

***Note:** The number of E-MADI64 cards you can fit to the matrix frame is limited by the available port count. There are 112 ports available on the Eclipse HX-Median.*

2. Power up the Eclipse HX-Median and open the EHX configuration software.
3. Add the E-MADI64 cards to the EHX configuration.

If you are creating a new configuration, use **Layout mode** to discover the cards:

- a. Drag the matrix frame into the work area.
- b. The New Configuration dialog is displayed. Select **Discover Hardware**.
- c. Click **OK**.

If this is an established configuration:

- a. Go to Hardware > Cards and Ports.
- b. To add the cards, do either of the following:

- Click **Detect New Hardware**. The cards are discovered and automatically assigned to a slot on the frame.
 - Use the drop-down lists to manually assign the cards to slots on the frame.
4. Configure EHX settings for the E-MADI64 cards. Standard EHX settings (including **VOX** and **In-use** tally) are applicable to **all** E-MADI64 channels.

***Note: Card Properties** permits sample rate selection when syncing to video signals. It is only used when **not** using the **Word Clock Source Sync** (see below).*

Card Properties always defaults to the E-MADI64 standard for the **number of channels**:

E-MADI64 channel mode	Sample rate	Configurable ports
32	96k	32
56	44.1k or 48k	56
64	44.1k or 48k	64, 32 or 16

5. Apply the changes to the frame with a reset.

6.4.1 Connecting a Word Clock Source

If you connect the **Word Clock** source to the **Clock Input** connector on the rear card (see the table in the previous section):

- The **WRD** LED on the front of the E-MADI64 card is lit **solid green**, indicating that the word clock has been detected and locked onto.
- The number of configured ports and the detected sample rate (as provided by the word clock) is indicated by **flashing green** LEDs (1:1 at 0.5Hz) on the front of the E-MADI64 card.
- The **Error** LED on the E-MADI64 card is lit **solid red**.

6.4.2 Connecting a Video Source

If you connect a video source to the **Clock Input** connector on the rear card:

- The **VID** LED on the front of the E-MADI64 card is lit **solid green**, indicating that the word clock has been detected and locked onto.
- The number of configured ports and the sample rate (configured in EHX) is indicated by **flashing green** LEDs (1:1 at 0.5Hz) on the front of the E-MADI64 card.

6.4.3 Connecting E-MADI 64 Audio (Using Coaxial or Fiber cable)

When you connect the external E-MADI64 Audio (using Coaxial or Fiber cable) to the rear of the E-MADI64 card:

1. The sample rate and the number of configured ports is indicated by a **solid green** LED on the front of the E-MADI64 card.
2. The **red Error** LED on the E-MADI64 card is **turned off**.
3. When the number of received channels differs from the number of channels configured in EHX, the **Channel** LEDs on the front of the E-MADI64 card **flash green**, oscillating between 2 types of port numbers.
4. When the received sample rate differs from the configured sample rate, the Sample rate LEDs on the front of the E-MADI64 card **flash green**, oscillating between 2 types of sample rates.
5. Audio passes into and out of the E-MADI64 card to the HX-Median backplane.

6.5 V-Series Panels on E-MADI (Multi-Channel Audio Digital Interface)

The E-MADI card supports up to 32 V-Series panels over a suitable infrastructure. To set up V-Series panels on MADI you need to:

- Run EHX version 8.5 or above.
- Configure the panel audio in the EHX software and the MADI software as necessary.
- Ensure that the panel is fitted with a V-Series AES options module (see V-Series Panel User Guide; 4.2.2 V-Series main panel rear connectors (AES 3) for more information.)

How the ports are configured in the software will depend on which MADI is used. See the next section for details.

6.5.1 Configuring Audio Over MADI, the General Case

Most third party equipment (e.g. RME, Lawo) treats the AES (Audio Engineering Society) streams from a MADI as 32 linked pairs, A and B channel together. So in the general case, the following strategy should be used to route the AES streams:

In the card/port configuration screen in EHX, the panels should be configured to the odd numbered ports (taking the first port as 1) of the E-MADI card. The even numbered ports may be left unused (Empty), leaving the panel with only the main channel audio (channel A). See the image below.

Note: It is not necessary to define a block of panels as consecutive odd numbers. For example, ports 1,3,9,11,51 could be defined as panels, with all the other slots unused or used for other purposes if required.

2. Set alternate ports to panels

1. Set card type

Card Slot	Port Number	Port Function	Label	Description
1: MXX-A16	3.1 (33)	V 2RU Lever		V-Series 2RU Lever
2: MXX-A16	3.2 (34)	Empty		
	3.3 (35)	V 1RU Push		V-Series 1RU Push
3: E-MADI 64/16	3.4 (36)	Empty		
4: Empty	3.5 (37)	V 1RU Lever		V-Series 1RU Lever
5: Empty	3.6 (38)	Empty		
6: Empty	3.7 (39)	V 2RU Lever		V-Series 2RU Lever
7: Empty	3.8 (40)	Empty		
8: Empty	3.9 (41)	V 2RU Push		V-Series 2RU Push
9: Empty	3.10 (42)	Empty		
10: Empty	3.11 (43)	V 2RU Rotary		V-Series 2RU Rotary
11: Empty	3.12 (44)	Empty		
12: Empty	3.13 (45)	V Desktop Lever		V-Series Desktop Lever
13: Empty	3.14 (46)	Empty		
14: LMC-64	3.15 (47)	V Desktop Rotary		V-Series Desktop Rotary
15: Empty	3.16 (48)	Empty		

To configure binaural audio on V-series panels on a MADi card in EHX go to: **EHX>Hardware>Cards and Ports.**

This example shows how to configure ports for audio streamed in pairs, A and B. Note that alternate ports have been set to accommodate paired audio streams.

6.5.2 Configuring Audio Over Optocore/ProGrid MADIs

Optocore/ProGrid MADIs have the advantage of allowing fully flexible audio routing.

Optocore/ProGrid interfaces allow each channel of the MADi to be routed individually to any channel on any destination node. The AES streams do not have to be routed and configured in pairs. The ProGrid equipment allows fully flexible routing and it is possible to mix close packed mono and conventional stereo pairs on one MADi interface. It is the routing matrix in the ProGrid equipment that is used to get the main panel port to the A channel of the AES interface.

For example, if ports 1,2,3,4,5,7,9,11... are defined as panels in EHX, the ProGrid must be used to ensure that the channels 1,2,3,4,5,7,9,11... are routed to and from the A channels of the AES interfaces.

Because of the free routing capabilities of the ProGrid, the routing of panel data is totally free format, so it is possible, for example, to define stereo panels where the main and aux channels are not defined on adjacent ports of the MADi. See Figure 6.4.

In all cases, when using a router such as ProGrid, ensure that the configuration of the E-MADI card and the configuration of the ProGrid matrix are consistent with each other.

1. Set card type

2. Set ports in any order

Port Number	Port Function	Label	Description
3.1 (33)	V 2RU Lever		V-Series 2RU Lever
3.2 (34)	V 1RU Lever		V-Series 1RU Lever
3.3 (35)	V 1RU Lever		V-Series 1RU Lever
3.4 (36)	V 1RU Lever		V-Series 1RU Lever
3.5 (37)	V 1RU Lever		V-Series 1RU Lever
3.6 (38)	V 1RU Push		V-Series 1RU Push
3.7 (39)	V 2RU Lever		V-Series 2RU Lever
3.8 (40)	V 2RU Push		V-Series 2RU Push
3.9 (41)	Empty		
3.10 (42)	Empty		
3.11 (43)	Empty		
3.12 (44)	Empty		
3.13 (45)	Empty		
3.14 (46)	Empty		
3.15 (47)	Empty		
3.16 (48)	Empty		

To configure V-series panels on a MADI card in EHX go to: **EHX>Hardware>Cards and Ports.**

This example shows how to configure ports for audio that is not streamed in pairs by the MADI interface (ProGrid). Note that ports do not have to be set to accommodate paired audio streams.

6.6 Configuring Binaural Audio with E-MADI Cards

When routing audio to a V-Series panel with a MADI64 card, the AES (Audio Engineering Society) audio streams can be set to operate binaurally (one channel to each headphone on a headset) using the main channel audio (A) and the auxiliary channel audio (B).

When setting up binaural audio over a V-Series panel with a MADI64 card you must:

- Configure the panel audio in the EHX software and the MADI software as necessary.
- Set the Audio Mixer screen option to display additional channels in the EHX user interface so they can be routed to the desired outputs.
- Use a headset with a minimum of a 5-pin input (use with an XLR5 or 7 adapter).

6.7 Configuring Binaural Panel Audio in Software

The main audio channel and the auxiliary audio channel need to be directed to the desired ports. This is achieved in the EHX software (**EHX/Hardware/Cards and Ports**). How the two

audio streams (channels A and B) are set up will depend on which MADi is used to connect the audio between the E-MADi64 card and the AES (Audio Engineering Society) module fitted to the V-Series panel.

6.7.1 Binaural Audio Over MADi, the General Case

Most third party equipment (e.g. RME, Lawo) treats the AES streams from a MADi interface as 32 linked pairs, A and B channel together. So in the general case, the following strategy should be used to route the AES streams for binaural audio:

In the card/port configuration screen in EHX, the panels should be defined on the odd numbered ports (taking the first port as 1) of the E-MADi card. The even numbered ports should be set to 'Panel Aux' to accommodate the second channel of audio. See the image below.

1. Set card type

2. Set alternate ports to panels

3. Set **Panel Aux** directly next to panel

Port Number	Port Function	Label	Description
3.1 (33)	V 2RU Lever		V-Series 2RU Lever
3.2 (34)	Panel Aux		Panel Aux
3.3 (35)	V 1RU Lever		V-Series 1RU Lever
3.4 (36)	Panel Aux		Panel Aux
3.5 (37)	V 1RU Lever		V-Series 1RU Lever
3.6 (38)	Panel Aux		Panel Aux
3.7 (39)	V 2RU Lever		V-Series 2RU Lever
3.8 (40)	Panel Aux		Panel Aux
3.9 (41)	Empty		
3.10 (42)	Empty		
3.11 (43)	Empty		
3.12 (44)	Empty		
3.13 (45)	Empty		
3.14 (46)	Empty		
3.15 (47)	Empty		
3.16 (48)	Empty		

To configure binaural audio on V-series panels on a MADi card in EHX go to:

EHX>Hardware>Cards and Ports.

This example shows how to configure ports for audio streamed in pairs, A and B.

Note that alternate ports have been set to accommodate paired audio streams. To enable binaural audio, set '**Panel Aux**' next to the main audio stream.

Optocore/ProGrid MADIs allow each channel of the MADi to be routed individually to any channel of any destination. The AES streams do not have to be routed and configured in pairs. The ProGrid equipment allows fully flexible routing and it is possible to mix close packed mono and conventional stereo pairs on one MADi interface.

It is the routing matrix in the ProGrid equipment that is used to get the main panel port to the A channel of the AES interface. Also, it is the routing matrix in the ProGrid that is used to pair the audio channels as required.

In all cases, when using a router such as ProGrid, ensure that the configuration of the E-MADI card and the configuration of the ProGrid matrix are consistent with each other.

For example, if ports 1,2,3,4,5,7,9,11... are defined as panels in EHX, the ProGrid must be used to ensure that the channels 1,2,3,4,5,7,9,11... are routed to and from the A channels of the AES interfaces.

6.8 Set the EHX Audio Mixer Screen Option for Binaural Audio Routing

1. Select Configuration>Panels>Audio Mixer>Layout Basic Settings in the EHX software and chose either Layout Binaural coax/AES or Layout Binaural coax/AES + D25. See the image below.

Select **Configuration>Panels>Audio Mixer>Layout Basic Settings>Layout Binaural coax/AES**

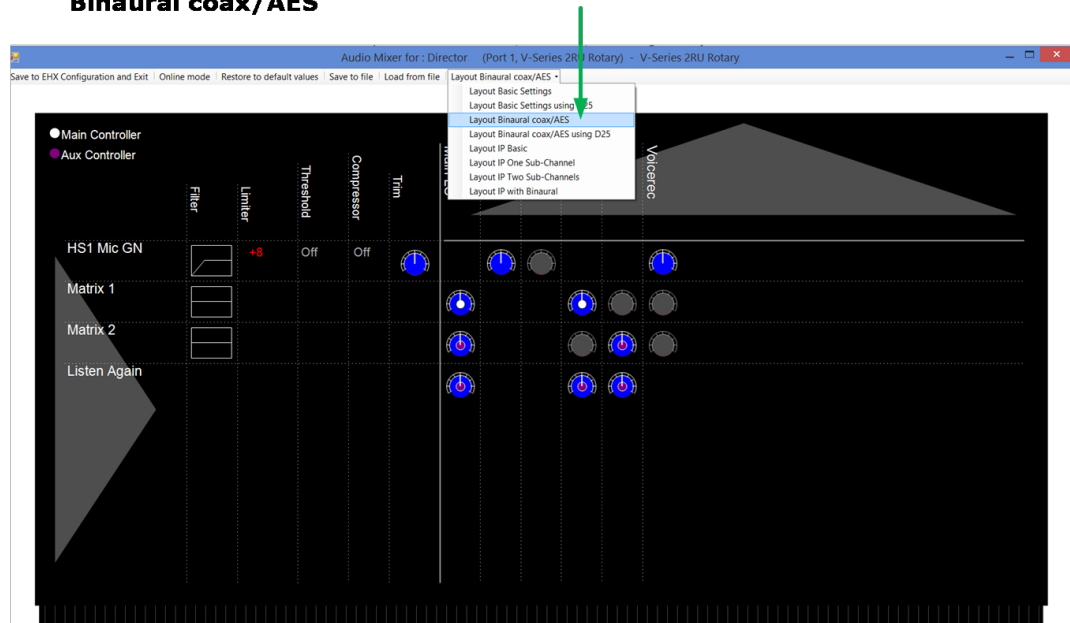

2. Set audio routes as required (see **EHX User Guide: Audio Mixer** for more information).

6.9 Upgrading the E-MADI64 Card

The E-MADI64 card is both **centrally** upgradable (you can upgrade the E-MADI64 thru the matrix frame, using EHX) and locally upgradable, using Xilinx software, a PC and a Xilinx download cable.

For more information, see the *Eclipse HX Upgrade Guide*.

7 E-FIB Fiber Card

This section describes how to connect Eclipse HX matrix frame using E-FIB fiber interface cards.

You should connect the E-FIB card to the highest slot number in the matrix.

E-FIB fiber interface cards connect Eclipse HX matrices together to provide a high speed, dual redundant link to transfer audio samples and data between systems. These connections can be configured in various ways to provide protection against the loss of a link or a node.

Each fiber interface comprises:

- A front card with various controls and status indicators (including a reset button, status LEDs for power, processor function, card status, link status and link activity).

***Note:** The link status and activity LEDs indicate whether there is activity on a link, whether the card is transmitting on a link and the error state of a link.*

- A rear card with two Duplex LC Terminated fiber optic connectors (**TXVRA** and **TXVRB**). The fiber interfaces use **9/125µ Single Mode fiber optic cables**.



The standard maximum node length is 10km but other distances are available to special order. For further details, see [Regulatory Compliance on page 170](#).

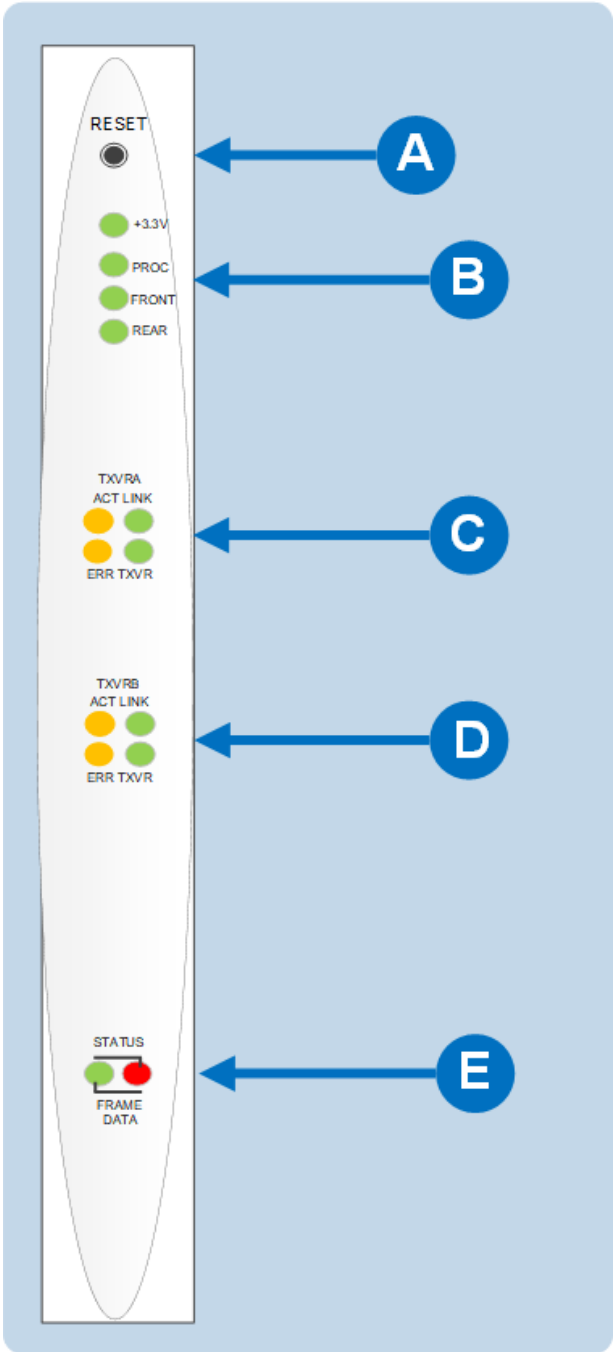

If fiber interfaces are fitted to any matrix in a linked system **all** the linked matrices must be reset to ensure that all matrices correctly recognize the new hardware.

***Note:** For an overview of the Eclipse HX-Median, see [Regulatory Compliance on page 170](#).*

7.1 E-FIB Front Panel Lights and Controls



Key to E-FIB front panel lights and controls	
Feature	Description
	<p>RESET button</p> <p>Pressing the RESET button causes the card and all links to momentarily stop their current activity and to restart. The card's frame data light goes off when the reset starts and comes back on when the reset is complete.</p> <p>During the reset, configuration information downloads to the card and its connected matrices from the CPU card. If the entire system is operating except for one fiber card press the reset button for that card only.</p> <p>Tip: The reset button is slightly recessed from the front panel to prevent it from being accidentally pressed. A tool such as a bent paper clip is needed to press this button.</p>
	<p>Power supply and Status lights</p> <p>+3.3-Volt Power Supply LED</p> <p>The matrix's +3.3-volt power supply provides electric current to this green light. When lit, the light indicates that the +3.3-volt supply is present and supplying electric current to the card.</p> <p>Processor LED</p> <p>When lit the LED indicates that the fiber card on-board processor is running</p> <p>Front Card LED</p> <p>When lit indicates that the front card is functioning normally.</p> <p>Rear Card LED</p> <p>When lit indicates that the rear card is functioning normally.</p>

Key to E-FIB front panel lights and controls	
	<p>Primary Link Status LEDs</p> <p>These LEDs indicate the status and functioning of the primary (A) fiber optic link.</p> <p>Link LED</p> <p>This LED indicates whether a link has been established on the primary fiber optic circuit (transceiver A). When illuminated a link is present.</p> <p>TXVR LED</p> <p>This LED indicates when data is being transmitted on the primary circuit. It is illuminated when data is present on the circuit.</p> <p>ACT LED</p> <p>This LED is lit if the primary fiber optic circuit is active.</p> <p>ERR LED</p> <p>This LED will be illuminated if an error condition is detected on the primary fiber optic circuit.</p>
	<p>Secondary Link Status LEDs</p> <p>These LEDs indicate the status and functioning of the secondary (B) fiber optic link.</p> <p>Link LED</p> <p>This LED indicates whether a link has been established on the secondary fiber optic circuit (transceiver B). When illuminated a link is present.</p> <p>TXVR LED</p> <p>This LED indicates when data is being transmitted on the secondary circuit. It is illuminated when data is present on the circuit.</p> <p>ACT LED</p> <p>This LED is lit if the secondary fiber optic circuit is active.</p> <p>ERR LED</p> <p>This LED will be illuminated if an error condition is detected on the secondary fiber optic circuit.</p>

Key to E-FIB front panel lights and controls	
	<p>Status LED</p> <p>The red status LED illuminates to indicate a failure in communication between the fiber card and the CPU card.</p> <p>Frame Data LED</p> <p>The green frame data LED illuminates to indicate successful communication between the fiber master card and the CPU card and that the card is the currently active fiber card (with regard to fiber card set redundancy).</p>

7.2 E-FIB Rear Panel Lights and Connectors

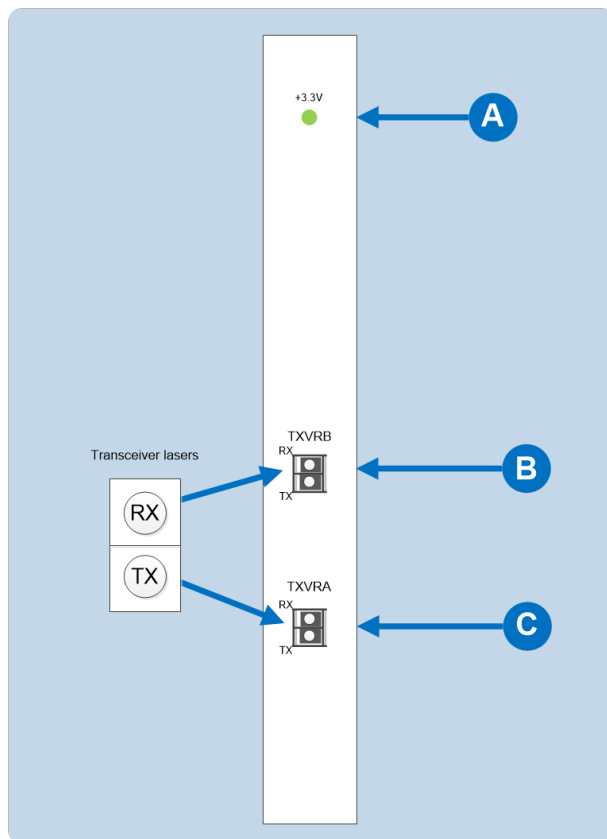



Warning: Eye Safety

This laser based single mode transceiver is a **Class 1 Laser product**. It complies with IEC 60825-1/A2:2001 and FDA performance standards for laser products (21 CFR 1040.10 and 1040.11) except for deviations pursuant to Laser Notice 50, dated July 26, 2001.

Normally a protective plug is fitted to the fiber connector to protect the connector from damage or the entry of foreign materials. The protective plug should only be removed in order to fit the fiber optic cable. Replace the plug when the cable is unplugged.

Primary and secondary fiber ports are reversed with respect to the front panel indicators.

Care should be taken when connecting or disconnecting cables to ensure that they are connected correctly and **not reversed**.

Key to E-FIB rear panel connectors	
Feature	Description
	<p>+3.3-Volt Power Supply LED</p> <p>When this green LED is lit, the +3.3-volt power supply (supplied by the matrix frame) is present and supplying electric current to the card.</p>
	<p>Fiber transceiver with Duplex LC type connector</p> <p>The TXVRB connector is used for the secondary ring.</p>
	<p>Fiber transceiver with Duplex LC type connector</p> <p>The TXVRA connector is used for the main ring.</p>

The fiber optic cable for the primary and secondary circuits are plugged into the appropriate ports. An example showing three systems configured with a primary and secondary ring is shown in the diagram below.

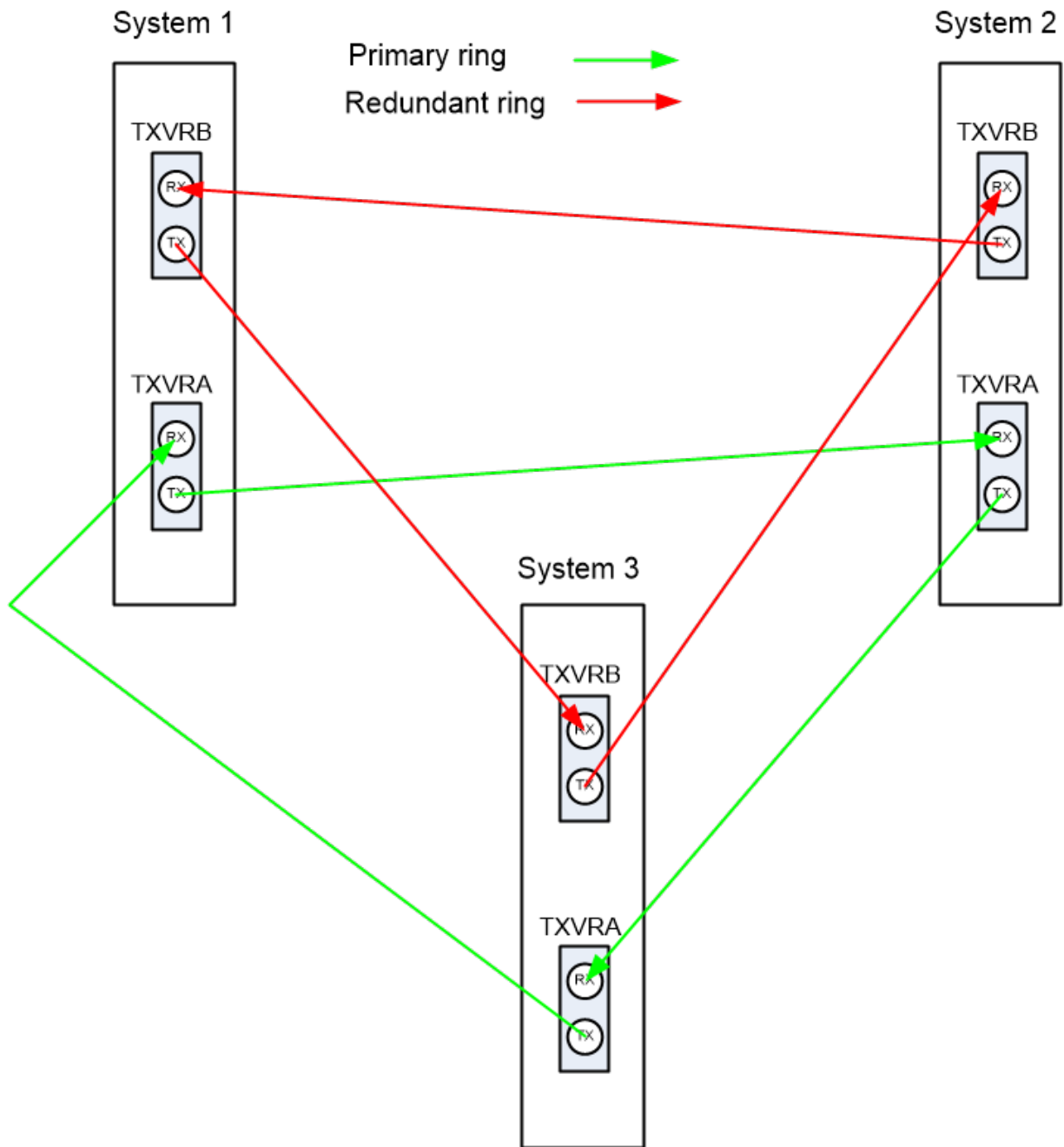

7.3 Configuring a Fiber Optic Connection

There are a number of ways that optical connections can be made between systems depending on the level of redundancy required.

When a break occurs in the fiber ring, a solid red status light will be shown at the fiber card downstream from the break and the link status LEDs may show **amber**. Other fiber cards will intermittently show **red**, as the ring attempts to recover. If the system layout is displayed by EHX the faulty links are shown in red.

In order to diagnose faults or switch between primary and secondary rings or between primary and backup fiber linking cards the **system monitoring screen** in EHX must be used.

Note: For more information about EHX, see your EHX documentation (including **EHX Help**).

7.4 Simplex Fiber Cabling

7.4.1 Single Card Set Redundancy

In this scenario, each matrix contains one fiber-optic Linking card set (see the diagram below).

This approach still affords fiber connection redundancy since each rear card houses two fiber-optic transceivers.

Note: In the absence of an **Uninterrupted Power Supply (UPS)**, this configuration **will not** protect against loss of the node or the matrix itself.

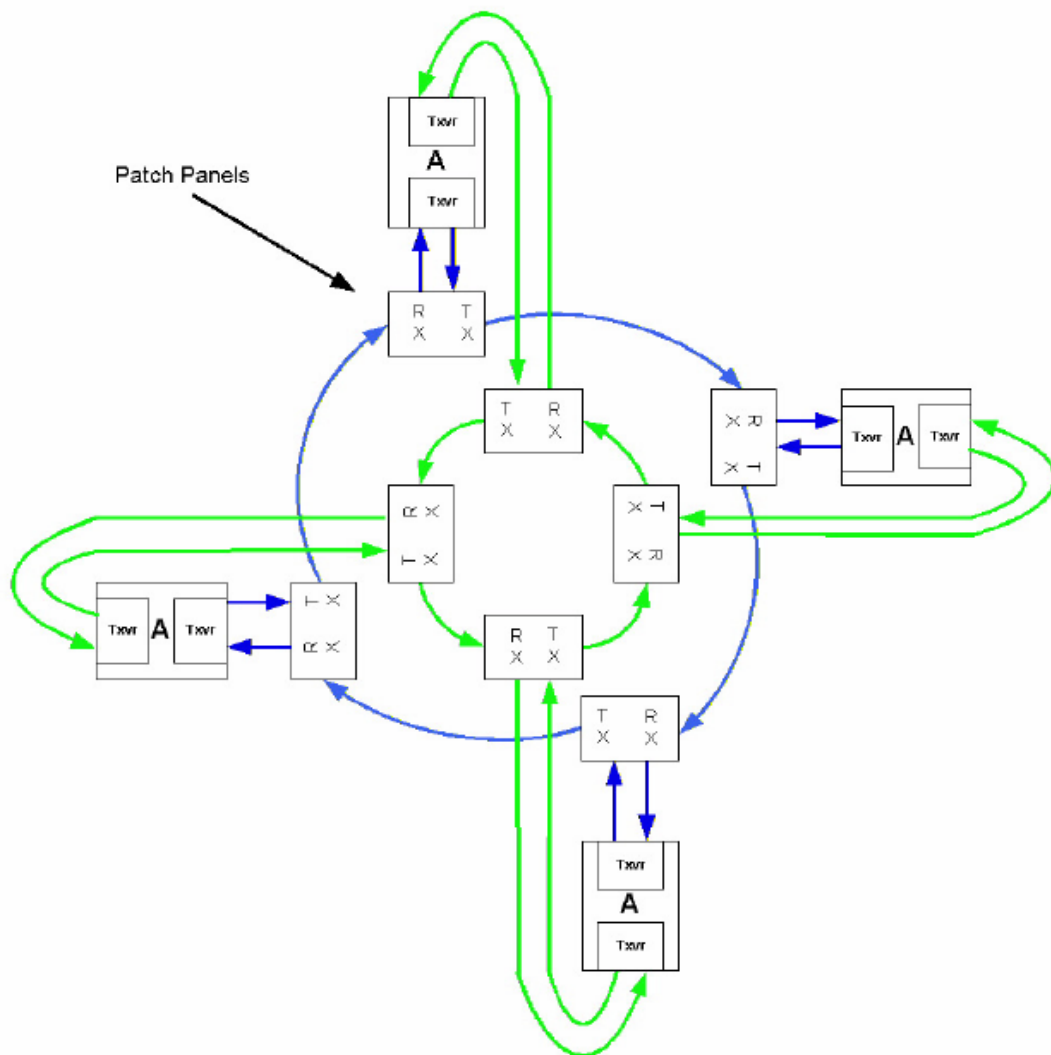

Loss of single fiber connection

When there is no break in the fiber connections the fiber audio will be routed using the primary ring.

If there is any connection failure on the primary ring and the secondary ring is intact then the fiber audio routing will move to the secondary ring.

The self-healing mechanism is performed automatically by the **Fiber Linking Card**. Switching to the secondary ring will cause audio breaks or disturbances and temporary loss of crosspoint data.

If a single fiber connection is lost on both rings the nodes adjacent to the failures will loop-back their connections to the failed cables healing the rings. In the state the fiber audio will therefore be routed utilizing both the primary and secondary fiber rings.

Note: *The Eclipse HX configuration software (EHX) will report any failures in the fiber connection system.*

Loss of a single node

If a node is lost on the ring the nodes adjacent to the failed node will loop-back their connections to the failed node healing the ring using the working remains of the ring. The configuration software (EHX) will report the failure.

This applies to the situation where the fiber card itself has failed rather than the matrix.

Loss of two fiber connections

If two adjacent fiber connections are lost on the ring, this will be handled as for the loss of a single node where the nodes adjacent to the failed node will loop-back their connections to the failed node healing the ring.

The configuration software will report the failure correctly as two failed cables. If two non-adjacent fiber connections are lost on the ring the nodes adjacent to the failures will loop-back their connections to the failed cables healing the ring into 2 separate smaller rings. The configuration software will report the failure.

Note: *In this instance the two sub-rings will be dependent on their Ethernet connections for configuration and data transmission but there will be no audio path between them.*

Loss of two nodes

If two adjacent nodes are lost on the ring this will be handled as for the loss of a single node where the nodes adjacent to the failed node will loop-back their connections to the failed nodes healing the ring. The configuration software will report the failure correctly as two failed nodes.

If two non-adjacent nodes are lost on the ring the nodes adjacent to the failures will loop-back their connections to the failed nodes healing the ring into 2 separate smaller rings. The configuration software will report the failure.

7.4.2 Dual Card Set Redundancy

The fiber linking function supports Dual card set redundancy. Both **Card set A** and **Card set B** are fitted in each node of the ring. In this case each matrix contains two **Fiber-optic Linking card sets**.

This approach affords full redundancy, offering protection against component failure within a single Fiber-optic Linking Card Set.

Note: *In the absence of an **Uninterrupted Power Supply** this configuration **willnot** protect against loss of the node or Matrix Frame itself.*

Parallel operation

The cabling and operation of both cards sets is the same as described in [Single Card Set Redundancy on page 103](#).

All card set A units in the linked set are network together forming a redundant fiber ring. However additionally all card set B units are additionally networked together to form a parallel redundant fiber ring. There is no fiber linkage between these two parallel fiber networks.

During normal operation each matrix monitors the number of nodes that are reachable on each of the two fiber networks. When there is parity between card set A and card set B then card set A will be used to route audio to and from the matrix.

Loss of fiber connections and nodes

As long all nodes are still deemed to be reachable on Card set A no switchover will be performed to Card set B.

Therefore, even if fiber connection issues on Card set A that a) result in a switch to the secondary ring (on Card set A) or b) result is a switch to loopback mode then Card set A will continue to be used to route audio to and from the matrix.

If sufficient fiber errors occur (either cabling or card failures) that result in the number of reachable nodes on Card set A dropping below that of Card set B then the matrix will switch to Card set B.

The currently active fiber card can be identified as it will flash its green status LED. The current backup (in active) fiber card will not illuminate its green status LED.

7.4.3 Fault Tolerance

In all fault cases involving recoverable cable faults or loss of nodes on one or both rings the remaining nodes may experience audio breaks or disturbances and temporary loss of crosspoint information or data.

Audio and data from a failed node will not be available to the remaining nodes for the duration of the failure. When a ring with non-adjacent failures sub-divides into two sub-rings, audio and data from the failed nodes **will not** be available to the nodes in either sub-ring.

Audio and data will continue to be available to nodes within the same sub-ring but data may still be available to all nodes that are still functioning if there is an intact, independent Ethernet connection to those nodes.

If a Matrix frame, connected as a node of the fiber-optic link is reset, powered down or failed this will constitute a lost or failed node on both rings and this node will experience audio breaks or disturbances and loss of crosspoint information or data for up to 5 seconds after the fault condition is cleared or repaired.

Single Card Set Redundant System: fiber redundancy

In all fault cases involving cable faults or loss of nodes on the ring the remaining nodes may experience audio breaks or disturbances and loss of crosspoint information or data.

When a ring with non-adjacent failures sub-divides into two sub-rings, audio and data from the failed nodes will not be available to the nodes in either sub-ring, audio will continue to be available to nodes within the same sub-ring but data may still be available to all nodes that are still functioning if there is an intact, independent Ethernet connection to those nodes.

If a matrix frame, connected as a node of the fiber-optic link is reset, powered down or failed this will constitute a lost or failed node on the ring and this node will experience audio breaks or disturbances and loss of crosspoint information or data for up to 5 seconds after the fault condition is cleared or repaired.

An example of how a system with multiple matrices would be wired together is shown in the following diagram.

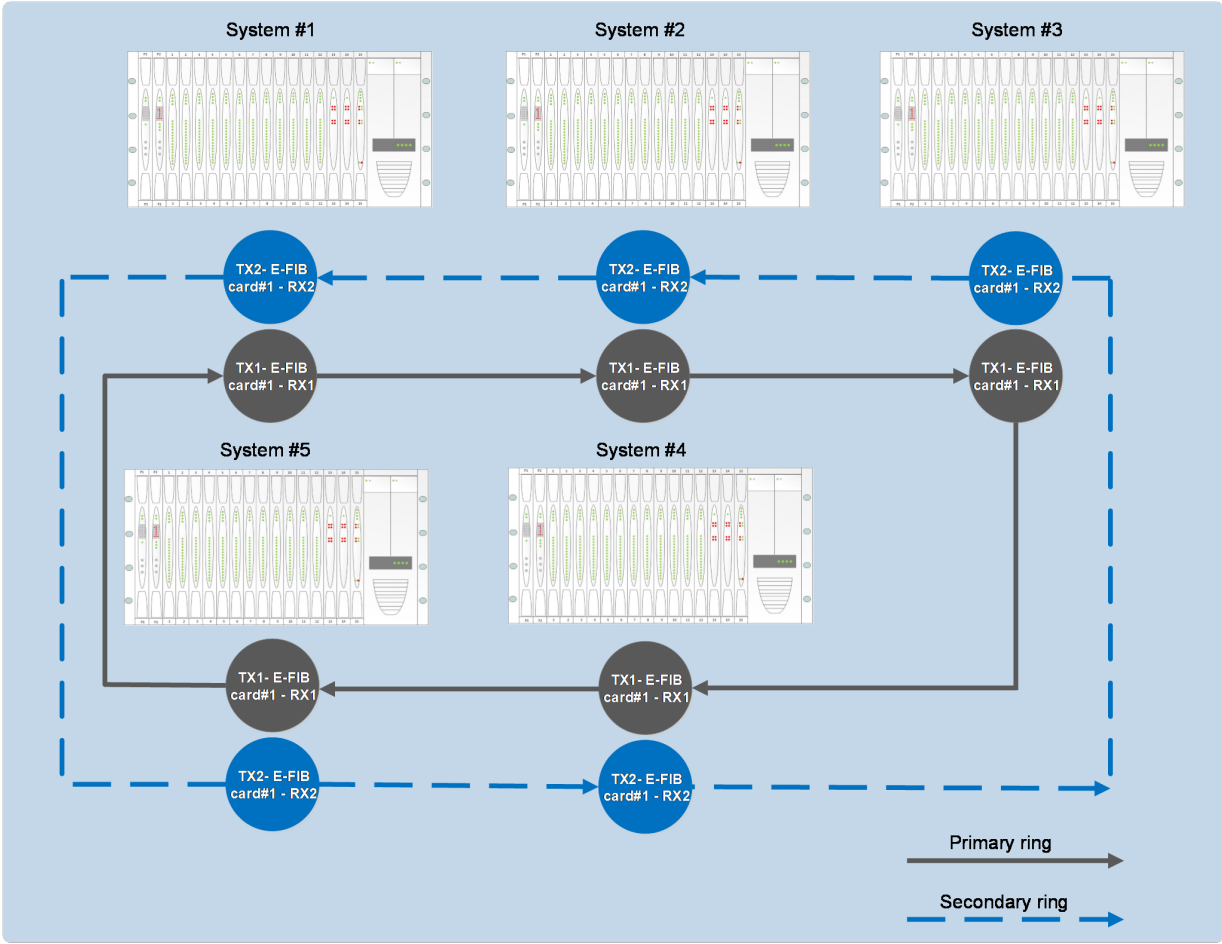

8 E-QUE E1/T1 Card

The E-QUE interface card allows you to connect the Eclipse matrix to FreeSpeak II antennas and FreeSpeak II antenna splitters, E1 and T1 trunk lines and E1 direct lines.

The E-QUE interface cards must be fitted in the rightmost available slots on the HX-Omega (furthest from the CPU cards). Up to four E-QUE interfaces can be fitted to an Eclipse HX-Median matrix. The connection options supported are:

- Up to 8 x FreeSpeak II antenna direct connections per E-QUE interface.
- Up to 2 x FreeSpeak II splitter connections (up to 5 antennas each) per E-QUE interface.

Using all four E-QUE interfaces that can be fitted would allow up to 40 antennas and 200 beltpacks to be connected to a matrix. The E-QUE interface also provides facilities for Direct and Trunk connections using E1 protocol and Trunk connections over T1 protocol. There are:

- 30 audio channels on each of 2 connectors (60 channels in total) available in E1 mode.
- 24 audio channels on each of 2 connectors (48 channels per card in total) are available in T1 mode.





Each E-QUE interface consists of a front card with a reset button and various status indicators, and a rear card with eleven RJ45 ports giving eight standard ports, DECT sync in and out and a LAN port. Each E-QUE front card has status LEDs for power, port activity and LAN status. The port activity LEDs indicate whether there is a device connected to an E1 port and that a connection has been established between this port and the connected device.

Note: *You **do not** require an Ethernet cable connected to the E-QUE card LAN port for the card to function correctly.*

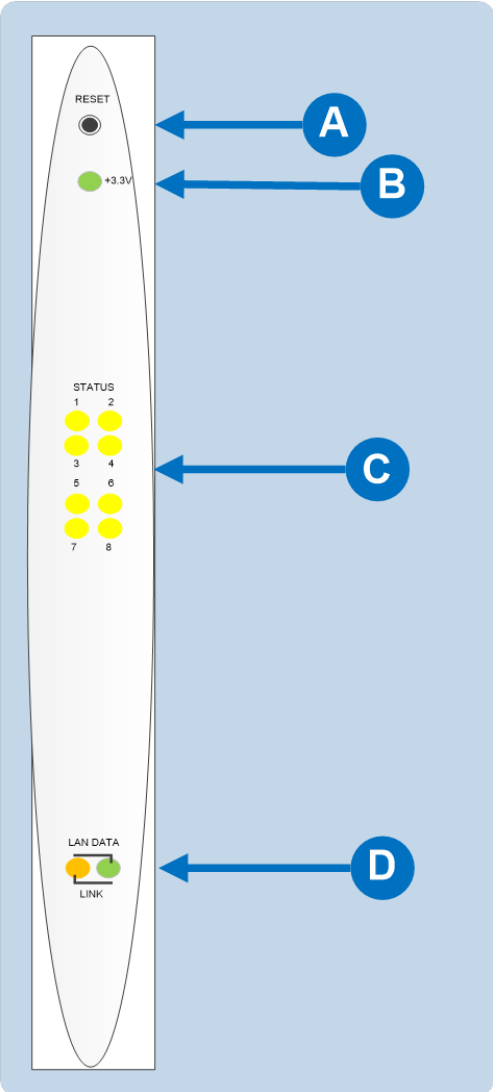
For an overview of the Eclipse HX-Median matrix, see [Overview on page 10](#).





8.1 E-QUE Front Panel Lights and Controls

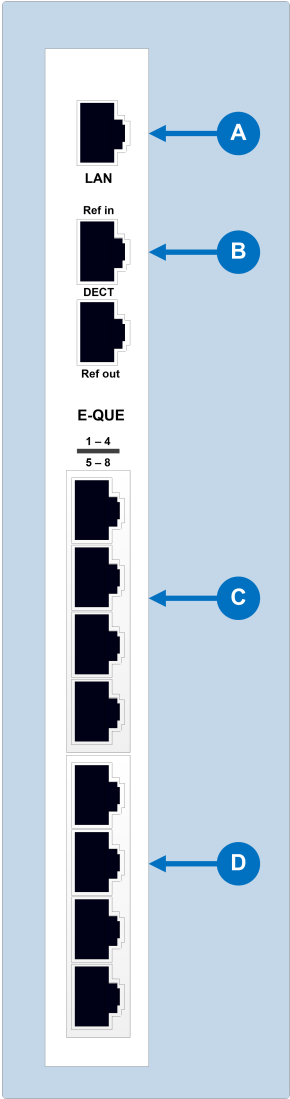

Key to E-QUE front panel lights and controls	
Feature	Description
	<p>RESET button</p> <p>Pressing the reset button causes the card and all links to momentarily stop their current activity and to restart.</p> <p>During the reset, configuration information downloads to the card from the CPU card. If the entire system is operating except for one E-QUE card press the reset button for that card only.</p> <p>Tip: The reset button is slightly recessed from the front panel to prevent it from being accidentally pressed. A tool such as a bent paper clip is required to press this button.</p>
	<p>Power supply lights</p> <p>+3.3-Volt Power Supply Light</p> <p>The matrix's +3.3-volt power supply provides electric current to this green light. When lit, the light indicates that the +3.3-volt supply is present and supplying power to the card.</p>
	<p>Status lights</p> <p>When lit, a status light indicates successful communication between the E-QUE card and a connected device such as an active antenna or splitter.</p> <p>Each of the E-QUE card's 8 yellow status lights corresponds to one of 8 ports to which devices can be connected.</p>
	<p>LAN DATA light</p> <p>The green LAN DATA light illuminates to indicate there is data passing through the Ethernet port.</p> <p>LAN LINK light</p> <p>The amber LAN LINK light illuminates to indicate a connection to the LAN port.</p>

8.2 E-QUE Rear Panel Connectors



Key to E-QUE rear panel connectors	
Feature	Description
	LAN port (RJ-45) The LAN port is used for diagnostic purposes.
	DECT sync ports: DECT Ref in DECT Ref out
	E1 / T1 Port 1 - 4(RJ-45)
	E1 / T1 Port 5 - 8 (RJ-45)

When multiple E-QUE cards are fitted in a rack, one of the cards generates a clock signal, which all other cards lock to, to ensure that all antennas remain in sync. The system is designed such that the leftmost card (seen from the front) is always the one which generates this signal.

This means that if the leftmost card is removed, or a new card is fitted to the left of existing cards, the antennas will lose lock for a few seconds as the cards re-configure themselves and a new card starts generating the sync signal.

Where multiple connected matrices are used containing E-QUE cards the DECT reference ports are connected as a daisy chain between the matrices to ensure that the DECT signals are synchronized through all the E-QUE cards present in the matrices.

Notes: *Failure to connect the DECT sync signal between matrices will result in poor utilization of the DECT bandwidth, and the system may operate poorly in a congested RF environment.*

The LAN port is used for diagnostic purposes.

8.3 E-QUE Interface Card Applications

The E-QUE interface card may be used to connect:

- FreeSpeak II antennas and splitters to an Eclipse HX matrix.
- Provide E1 and T1 connections to other systems.

Note: *For more information about E1 and T1 cable pinouts and cable connections, see:*

- [E1/T1 Matrix to Matrix Straight Cable Connections on page 53](#)
- [E1 to FreeSpeak II Antenna Straight Cable Connection on page 54](#)

8.3.1 FreeSpeak II Application

The E-QUE interface cards can be configured for FreeSpeak II use in two modes, depending on whether antennas or splitters are to be connected.

If the E-QUE interface card is configured:

- **In Antenna mode** all eight E1/T1 ports can be used to connect up to eight antennas.
- **To support splitters**, only two ports are active (ports 1 and 5) allowing a maximum of two splitters to be connected. Each splitter can support up to five antennas.

When the E-QUE interface cards are used in FreeSpeak II mode, they cannot be connected to the antennas via third party equipment or via fiber as the antennas require the DECT sync signal and this will not be converted by third party equipment or fiber interfaces.

Three connections schemes are illustrated below.

E-QUE card antenna connection...

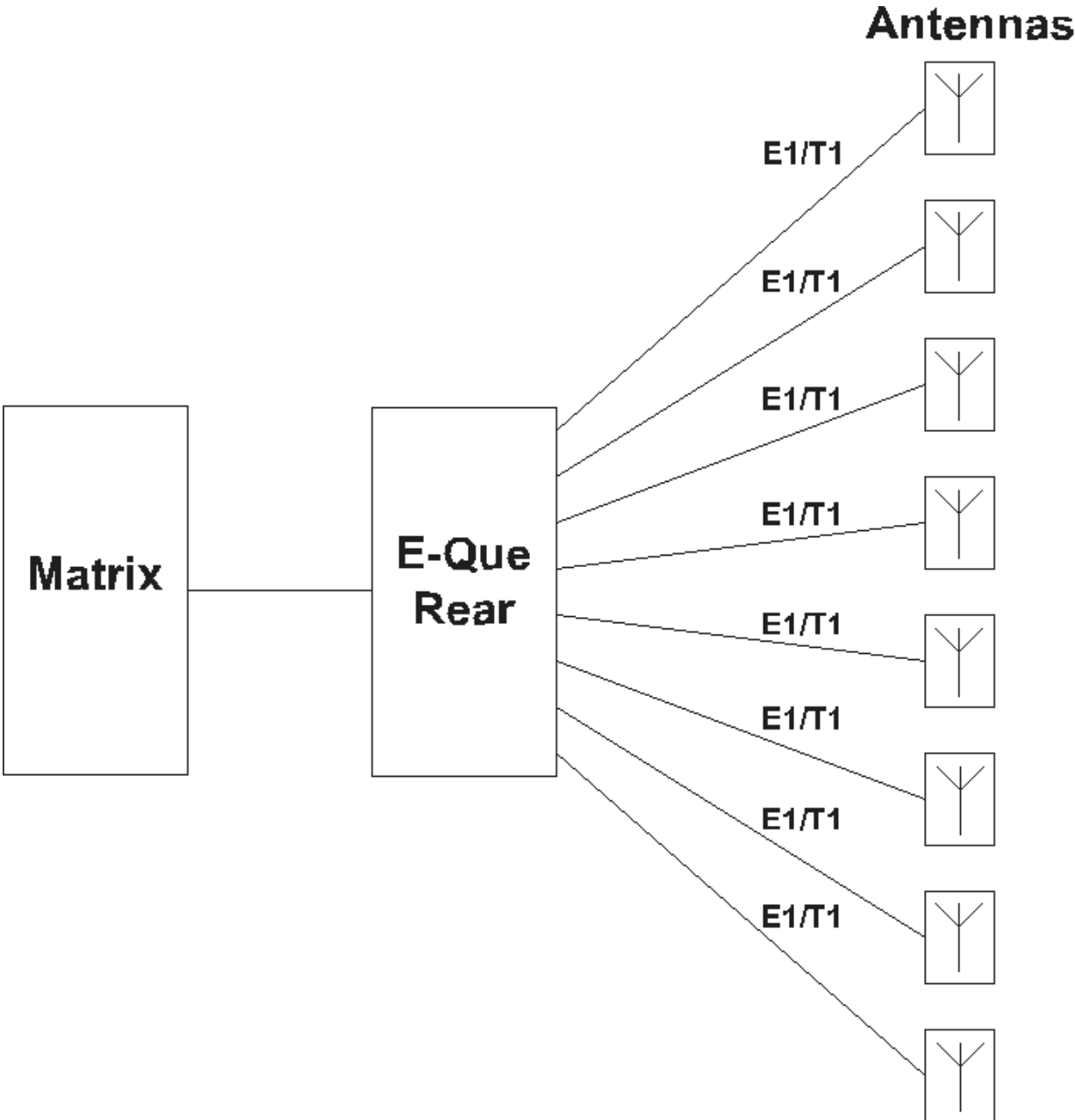

E-QUE card splitter connection...

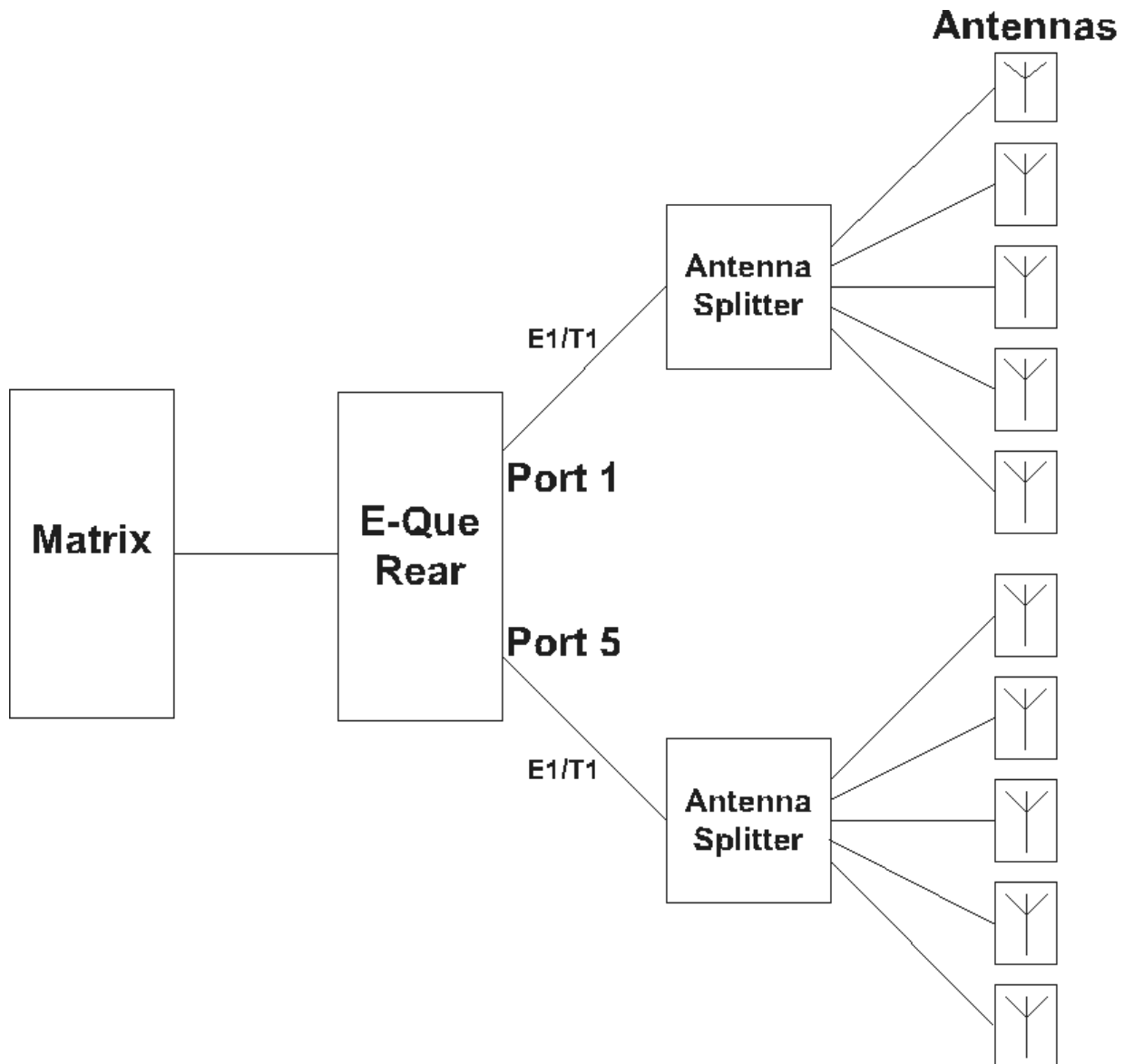

Each antenna can handle up to five beltpacks simultaneously and switch service between antennas under control of the matrix as the beltpack user moves around the site.

The DC In power connector is used to locally power the transceiver/antenna with the supplied universal power supply. Use of local power is always required when the transceiver/antenna is connected directly to the E-QUE rear card (rather than via a splitter), and may be required if the antenna is located more than 100 meters (328 feet) from a splitter. It is recommended even when the transceiver/antenna is closer whenever it is available and convenient.

Note: *It is recommended that shielded CAT5 cable is used for all wireless installations.*

Where multiple matrices are networked together with antennas or splitters connected to E-QUE interface cards on more than one matrix the E-QUE interfaces should have the DECT Sync links between matrices to ensure the correct operation of the FreeSpeak II system.

Multiple E-QUE interface cards within a single matrix do not require external DECT sync cables, connected as the signal uses the backplane.

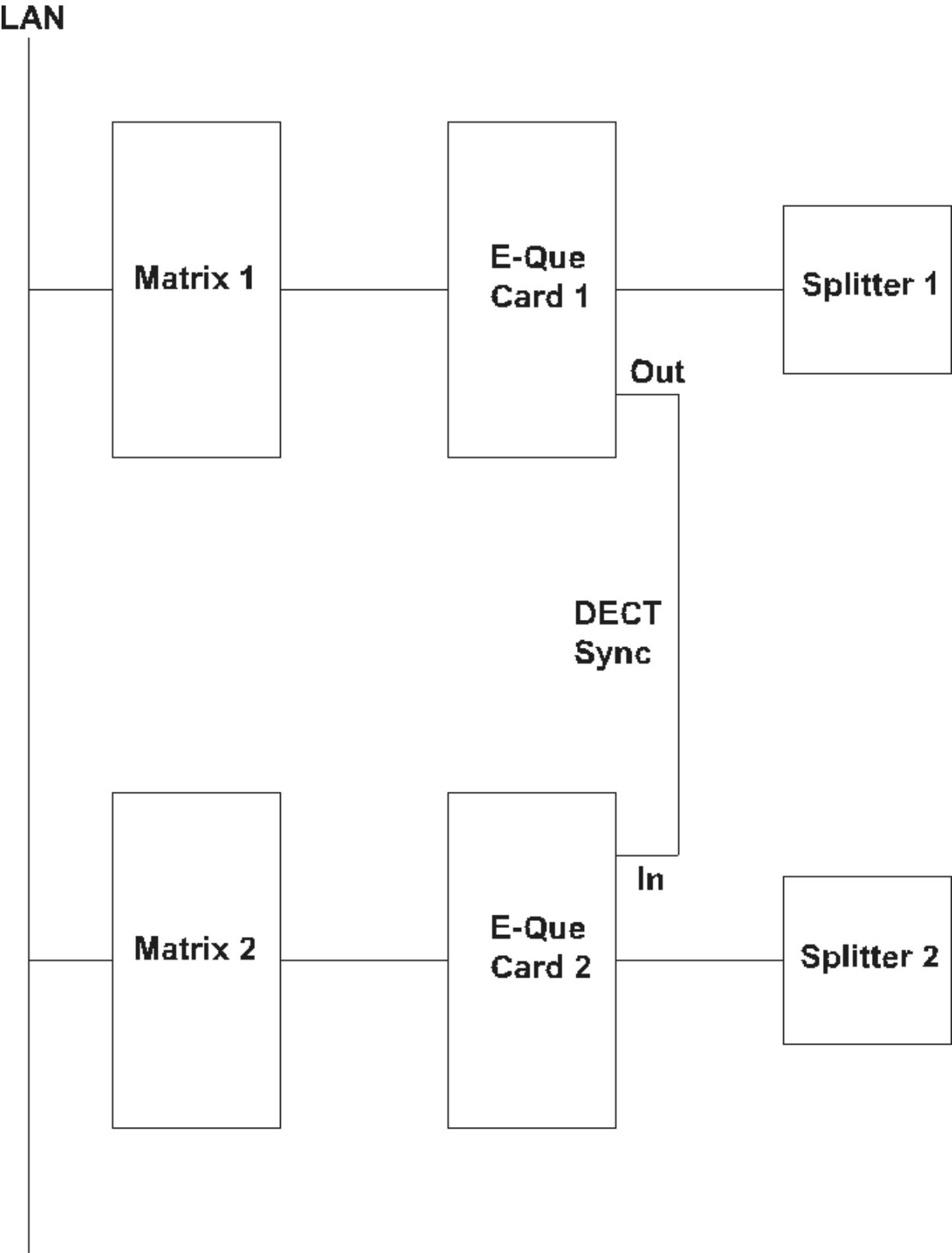

Notes: All connections are made using CAT5 cable and it is recommended that shielded cable is used.

If an E-QUE interface is fitted in the matrix with antennae or splitters connected and active inserting a second E-QUE interface to the left of the first interface (seen from the front) will cause a temporary loss of audio to beltpacks using the original E-QUE interface (usually for about 10 seconds). The beltpacks do not go offline and signalization is not lost.

8.3.2 Recommended Powering and Cable Lengths

The tables in this section list the maximum cable distances and power requirements for a FreeSpeak II matrix system. Separate table are provided for 24 AWG and 26 AWG cabling.

24 AWG Cat5/6 shielded cable	
System components	Distance
Matrix to transceiver (with local transceiver power)	800 m (2624 feet)
Matrix to splitter <i>Note: The splitter must always have local power</i>	800 m (2624 feet)
Splitter to transceiver (no local transceiver power)	100 m (328 feet)
Splitter to transceiver (with local transceiver power)	800 m (2624 feet)

26 AWG Cat5/6 shielded cable	
System components	Distance
Matrix to transceiver (with local transceiver power)	400 m (1312 feet)
Matrix to splitter <i>Note: The splitter must always have local power</i>	400 m (1312 feet)
Splitter to transceiver (no local transceiver power)	50 m (164 feet)
Splitter to transceiver (with local transceiver power)	400 m (1312 feet)

8.4 E1 Trunk and Direct Modes

The E-QUE interface can be used for both direct E1 to E1 port connections or to provide trunk linking via a network between systems. The E1 connections can be made between Eclipse systems or between Eclipse systems and compatible third-party equipment. E1 mode provides

30 channels of G.722 or G.711 encoded audio available on each of ports 1 and 5, giving 60 channels per card.

The **E1 specifications** are:

- HDB3 Encoding.
- Long Haul Receive Signal Level.
- E1 120 Ohm Transmit Pulse Amplitude.
- Balanced.
- 120 Ohm Line Impedance.
- No Signaling.
- G.722 or G.711 64 kbit/s Audio Encoding.
- Tx Clock locally generated.
- Rx Clock Line Recovered.

The following diagram shows E1 trunking using a direct connection between the matrices using a CAT5 crossover cable. The E-QUE interface should be set to **E1 Direct** in EHX hardware setup.

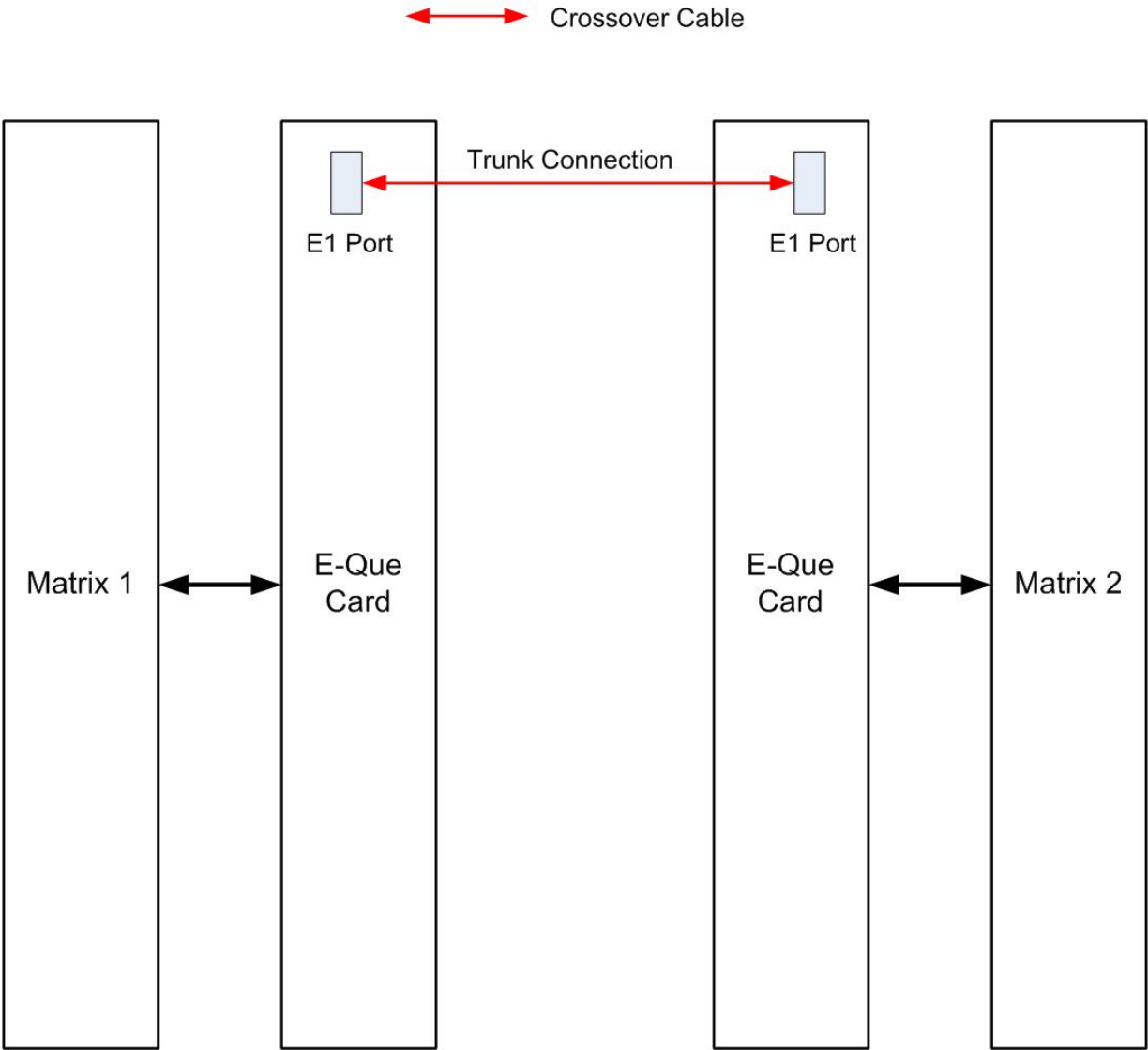

E1 trunking between matrices can also be achieved over an E1 network, as shown in the next diagram.

In this case E1 ports 1 and 5 of the E-QUE interface are connected using standard straight-through CAT5 cables rather than crossover CAT5 cables.

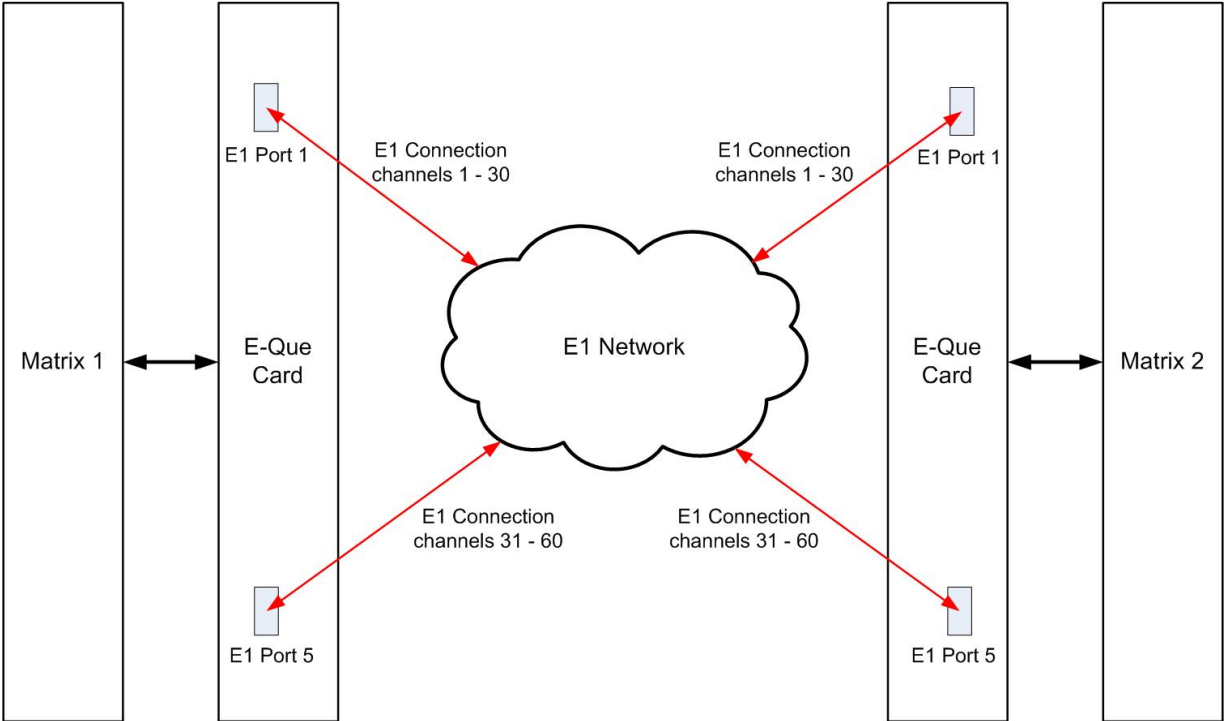

The E-QUE interface can also be used to connect the matrix to third party equipment using E1 port 1 or 5.

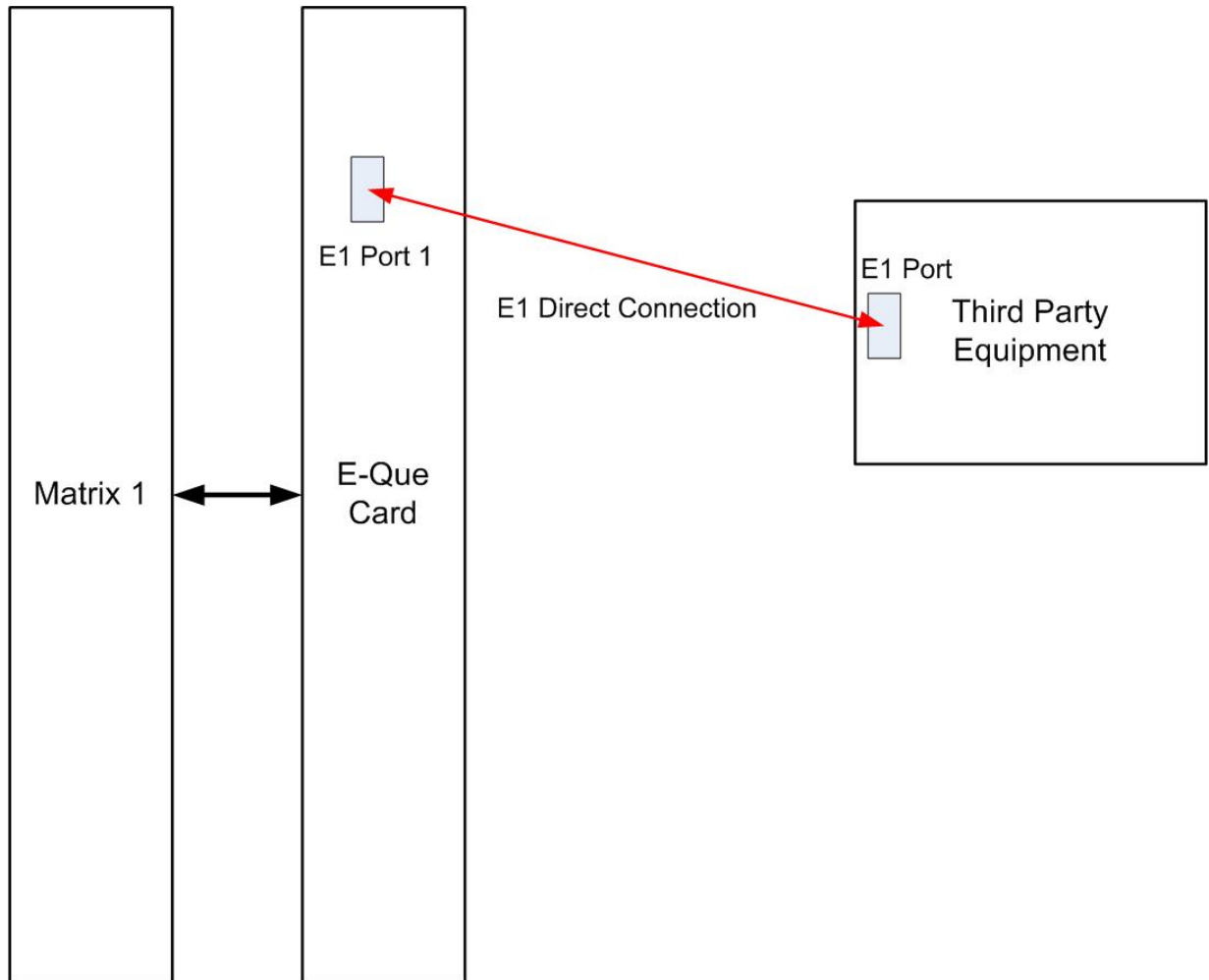

The CAT5 cable connecting the E1 port on the E-QUE rear card may be a crossover cable or a straight-through cable depending on the requirements of the third party equipment. The E-QUE interface should be set to **Direct** in EHX.

8.5 T1 Trunking

The E-QUE interface card can provide T1 trunking between Eclipse systems and between Eclipse systems and compatible third-party equipment.

T1 mode provides 24 channels of G.722 or G.711 encoded audio are available on each of ports 1 and 5, giving 48 channels per card.

The T1 trunking specifications are:

- B8ZS Encoding.
- Extended Super Frame.
- Long Haul Receive Signal Level.
- T1 Long Haul (LBO 0 dB) Transmit Pulse Amplitude.

- Balanced.
- 120 Ohm Line Impedance.
- No Signaling.
- G.722 or G.711 64 kbit/s Audio Encoding.
- Tx Clock locally generated.
- Rx Clock Line Recovered.

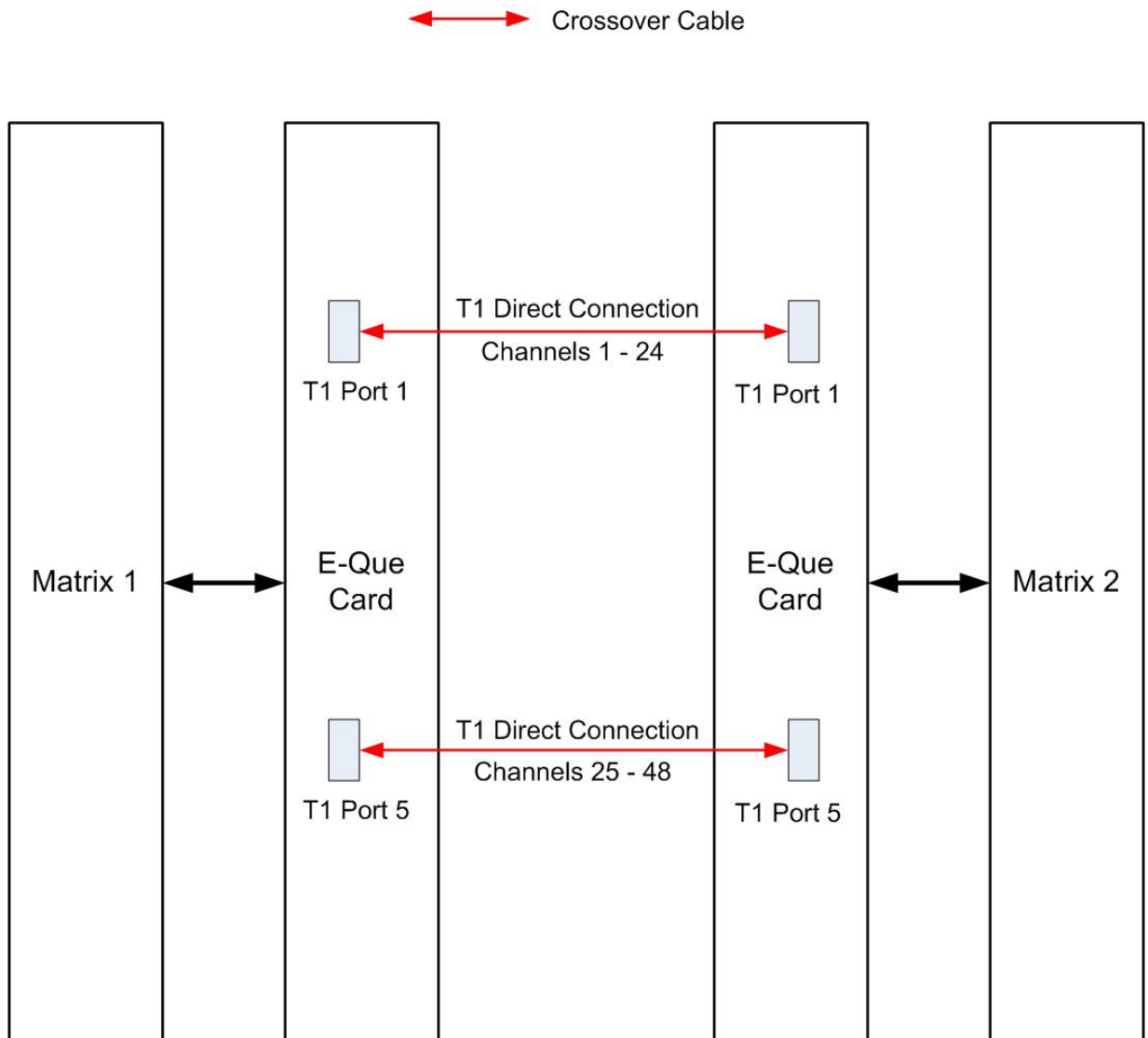

T1 trunking between matrices can also be achieved over an E1 network as shown in the following diagram.

In this case T1 ports 1 and 5 of the E-QUE rear card are connected using standard straight-through CAT5 cables rather than crossover CAT5 cables.

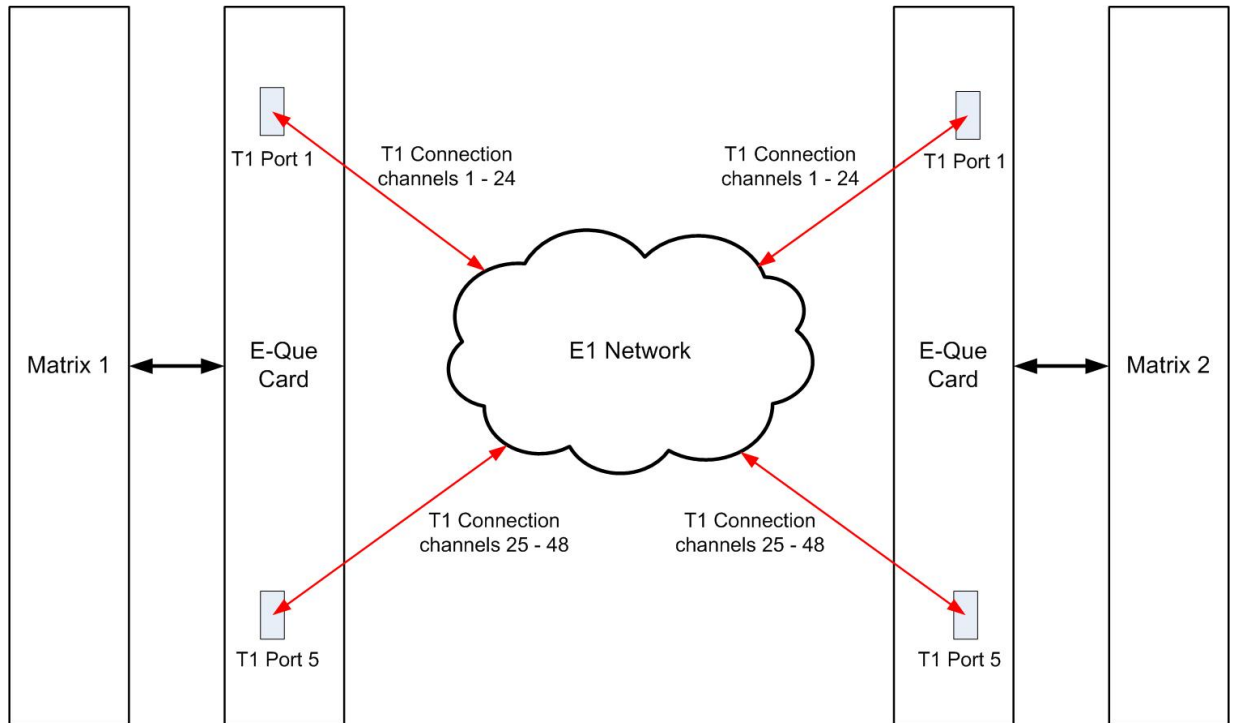

8.6 Trunking Failover

Where the E1/T1 trunking has been configured with redundant trunks audio will be switched from the primary trunk to the backup trunk when a failure is detected.

When failover occurs from primary to backup there will be a three second audio break on any route running over the trunk.

If the trunk routing is later switched back from the backup trunk to the primary trunk there will be no loss of audio.

9 IVC-32 Card for IP-Based Connections

The **IVC-32 (Instant Voice Communication) interface card** provides the Eclipse HX-Median with connectivity over IP to **V-Series IP panels and Concert servers**.

Each IVC-32 interface card comprises:

- A front card with a reset button and various status indicators (including status LEDs for power, port activity and LAN status).

***Note:** The port activity LEDs are not active on the IVC-32 front card as the E1/T1 ports are not used.*





- A rear card with eleven RJ-45 ports giving eight E1/T1 ports (not used), DECT sync in and out (not used) and a LAN port used for the IP connection.

Notes: *An Ethernet cable **must be** connected to the IVC-32 interface LAN port for the card to function correctly.*

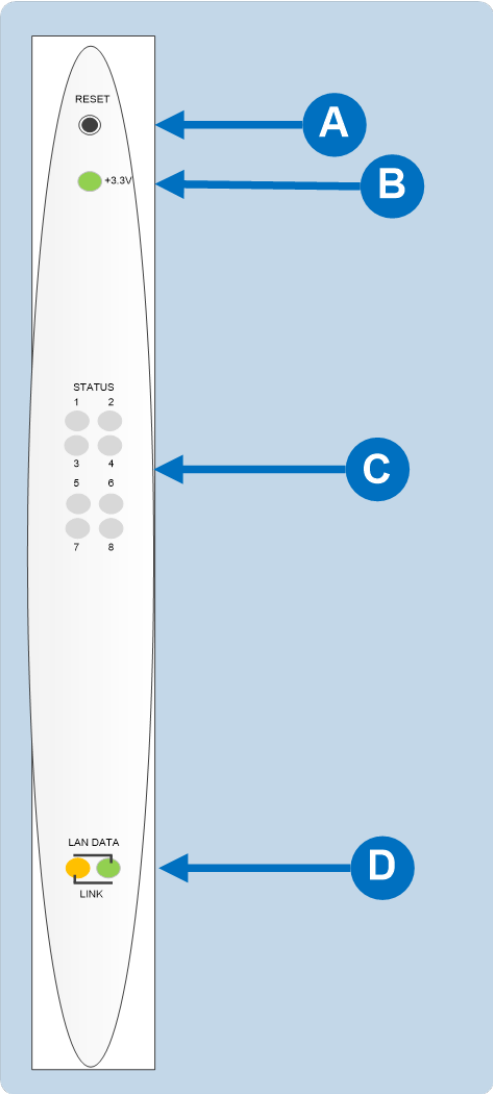
For an overview of the Eclipse HX-Median, see [Overview on page 10](#).





9.1 IVC-32 Front Panel Lights and Controls

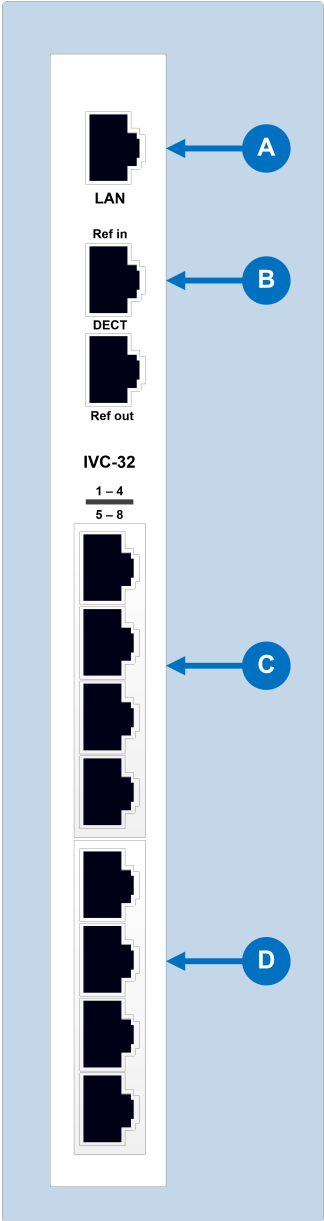

Key to IVC-32 front panel lights and controls	
Feature	Description
	<p>RESET button</p> <p>Pressing the reset button causes the card and all links to momentarily stop their current activity and to restart.</p> <p>During the reset, configuration information downloads to the card from the CPU card. If the entire system is operating except for one IVC-32 interface card, press the reset button for that card only.</p> <p>Tip: The reset button is slightly recessed from the front panel to prevent it from being accidentally pressed. A tool such as a bent paper clip is required to press this button.</p>
	<p>Power supply light</p> <p>+3.3-Volt Power Supply Light</p> <p>The matrix's +3.3-volt power supply provides electric current to this green light. When lit, the light indicates that the +3.3-volt supply is present and supplying power to the card.</p>
	<p>Status lights</p> <p>When lit, a yellow status light indicates IP communication between the card and E1/T1 connected devices. The first status light represents the first four connected panels, the second the next four panels, and so on.</p> <p>Under normal circumstances, however, E1/T1 devices are not connected to an IVC-32 interface card, which means that these lights are normally inactive.</p>
	<p>LAN DATA light</p> <p>The green LAN DATA light illuminates to indicate there is data passing through the Ethernet port.</p> <p>LAN LINK light</p> <p>The amber LAN LINK light illuminates to indicate a connection to the LAN port.</p>

9.2 IVC-32 Rear Panel Connectors



Key to IVC-32 rear panel connectors	
Feature	Description
	LAN port (RJ-45)
	DECT sync ports: DECT Ref in (Not used) DECT Ref out (Not used)
	E1 / T1 Port 1 - 4 (Not used)
	E1 / T1 Port 5 - 8 (Not used)

Note: The E1/T1 and DECT ports **are not** used on the IVC-32 interface and **should not be connected**.

9.3 IVC-32 Interface Applications

The IVC-32 interface may be used to connect:

- V-Series IP panels to an Eclipse matrix.
- Provide a link to a Concert Instant Voice Router (IV-R) server.

9.3.1 V-Series IP Panels

V-Series panels with V5.1 or later software may be enabled to communicate with an Eclipse HX-Median matrix over an IP network using the IVC-32 interface card.

The advantage of using IP communication is that it enables remote panels to communicate over an existing local (LAN) or wide area (WAN) network rather than requiring a dedicated link.

10 LMC-64 Metering Card

The **Level Meter Card (LMC-64) interface card** enables the Eclipse HX-Median to provide audio level metering for Dynam-EC over a network.

Each LMC-64 interface card can meter up to 64 virtual partylines (conferences) and four-wire ports.

The LMC-64 interface comprises:

- A front card with a reset button and various status indicators (including status LEDs for power, port activity and LAN status).

Note: *The port activity LEDs are **inactive** on the LMC-64 front card as the E1/T1 ports **are not** used.*





- A rear card with eleven RJ45 ports giving eight E1/T1 ports (not used), DECT sync in and out (not used) and a LAN port used for the IP connection.

Notes: *An Ethernet cable must be connected to the LMC-64 interface LAN port for the card to function correctly.*

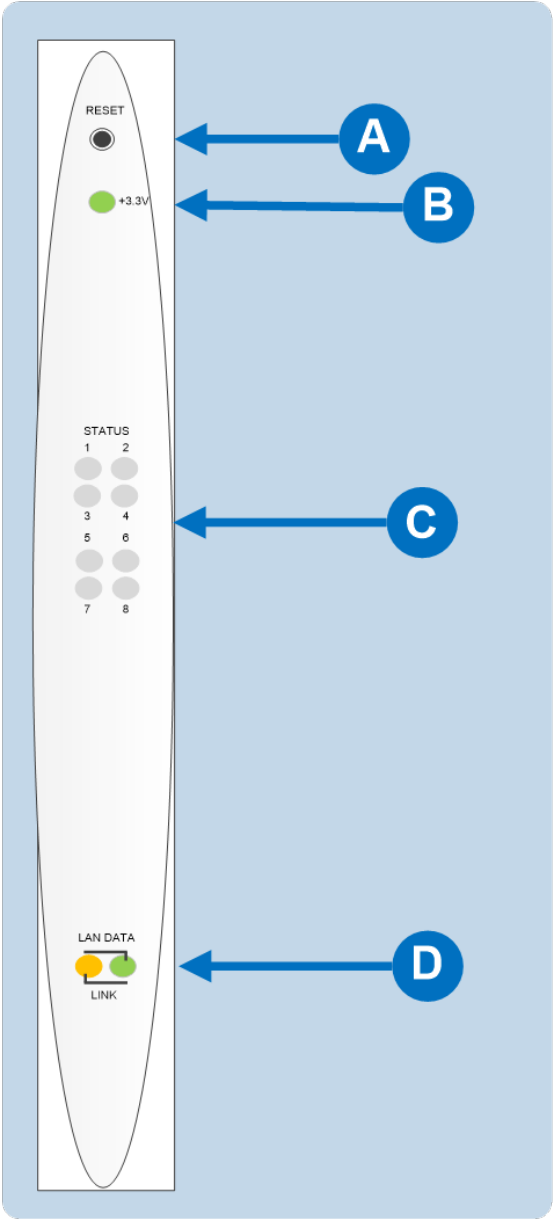
For an overview of the Eclipse HX-Median, see [Overview on page 10](#).





10.1 LMC-64 Front Panel Lights and Controls

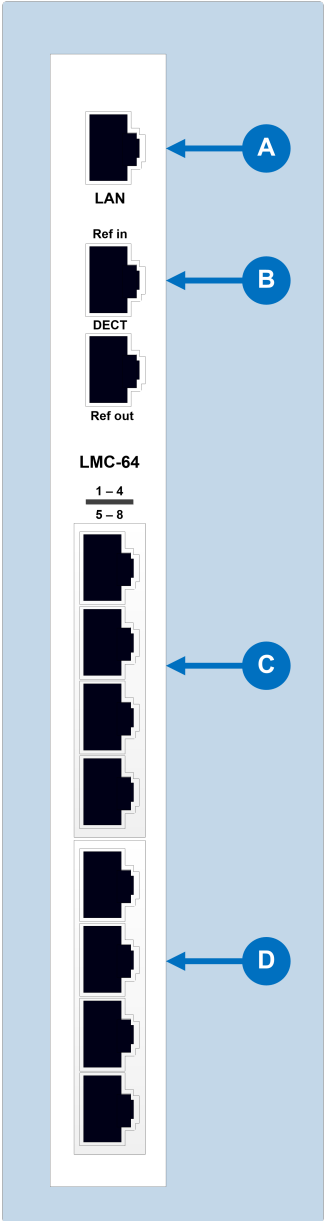

Key to IVC-32 front panel lights and controls	
Feature	Description
	<p>RESET button</p> <p>Pressing the reset button causes the card and all links to momentarily stop their current activity and to restart.</p> <p>During the reset, configuration information downloads to the card from the CPU card. If the entire system is operating except for one LMC-64 interface press the reset button for that card only.</p> <p>Tip: The reset button is slightly recessed from the front panel to prevent it from being accidentally pressed. A tool such as a bent paper clip is required to press this button.</p>
	<p>Power supply light</p> <p>+3.3-Volt Power Supply Light</p> <p>The matrix's +3.3-volt power supply provides electric current to this green light. When lit, the light indicates that the +3.3-volt supply is present and supplying power to the card.</p>
	<p>Status lights (normally inactive)</p> <p>When lit, a yellow status light indicates successful communication between an E1/T1 port on the LMC-64 interface and a connected E1/T1 device such as an active antenna or splitter.</p> <p>However, under normal circumstances, E1/T1 devices are not connected to an LMC-64 interface, which means that these lights are normally inactive.</p>
	<p>LAN DATA</p> <p>The green LAN DATA light illuminates to indicate there is data passing through the Ethernet port.</p> <p>LAN LINK</p> <p>The amber LAN LINK light illuminates to indicate a connection to the LAN port.</p>

10.2 LMC-64 Rear Panel Connectors



Key to LMC-64 rear panel connectors	
Feature	Description
	LAN port (RJ-45)
	DECT sync ports: DECT Ref in (Not used) DECT Ref out (Not used)
	E1 / T1 Port 1 - 4 (Not used)
	E1 / T1 Port 5 - 8(Not used)

Note: The E1/T1 and DECT ports are not used on the IVC-32 interface and should not be connected.

10.3 LMC-64 Interface Applications

The LMC-64 interface broadcasts audio level data to Dynam-EC clients over an IP network. This enables multiple Dynam-EC clients across a network to display any audio level that is being metered.

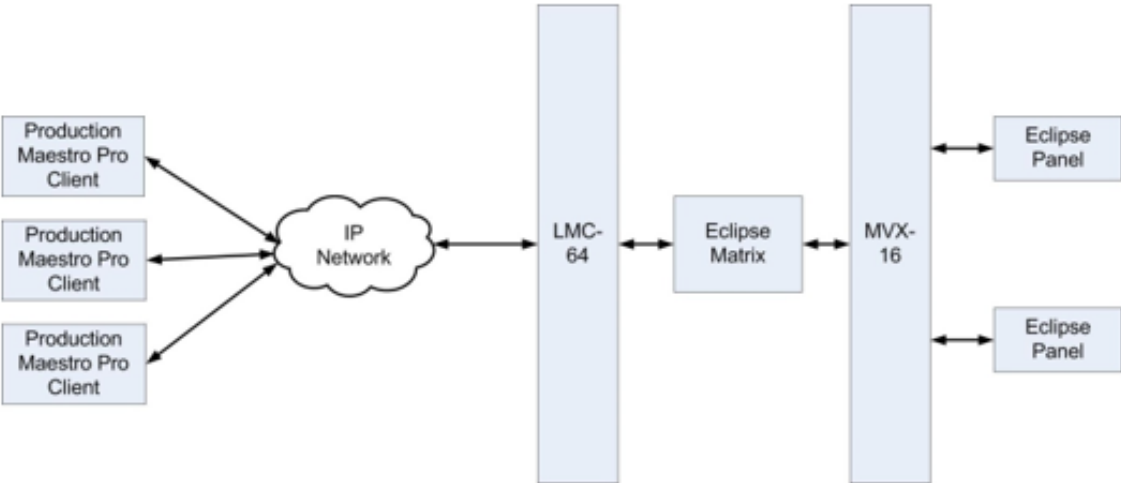

11 E-DANTE64-HX Card

Note: *E-DANTE64-HX card includes licence from Audinate Pty Ltd under U.S. patent number (s) 7747725, 8005939, 7978696, 8171152 and other patents issued, see www.audinate.com/patents*

This section contains information about audio networking using an E-DANTE64-HX interface card. This is a Clear-Com matrix interface card that is enabled to work with Dante network protocols and software so that you can transport many channels of high quality audio via a Clear-Com matrix to multiple Dante enabled devices using standard Ethernet network structure (up to 64 channels per E-DANTE64 card).

This section will describe and illustrate the card with its connections, controls and status LEDs. It will also cover how to install the card. There are also sections on how to upgrade the devices and a troubleshooting or FAQ section.

This guide uses some screenshots and instructions from Audinate documentation for your convenience. Be aware that while these are correct at the time of publishing, Audinate may change its documentation and user interfaces. If in doubt, refer to the Audinate documentation.

For information about configuring the card, see the ***EHX Configuration User Guide*** and ***Audinate*** documentation.

For recommendations for network devices and infrastructure, refer to www.audinate.com, and for specific AES-67 support refer to the Clear-Com Solution Finder, <https://www.clearcom.com/Download-Center>.

11.1 Example Applications

11.1.1 Interruptible Foldback (IFB) over Dante

Example application, broadcasting.
Interruptible Foldback (IFB) over Dante.

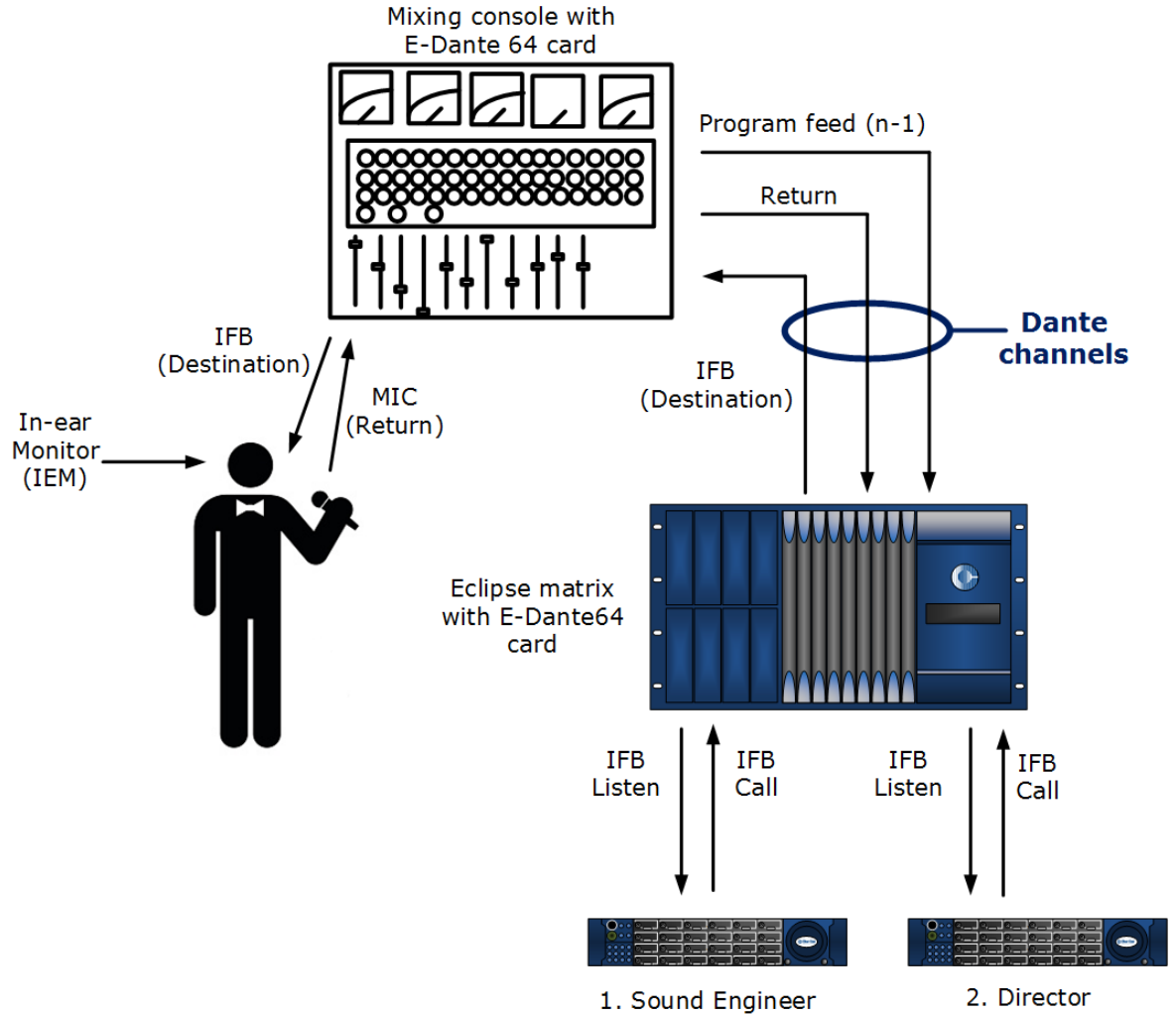

EHX IFB configuration

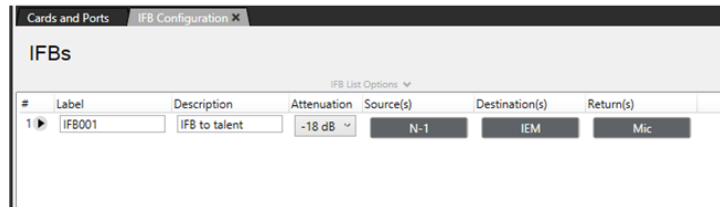

11.1.2 Live Performance Interface with Digital Intercom

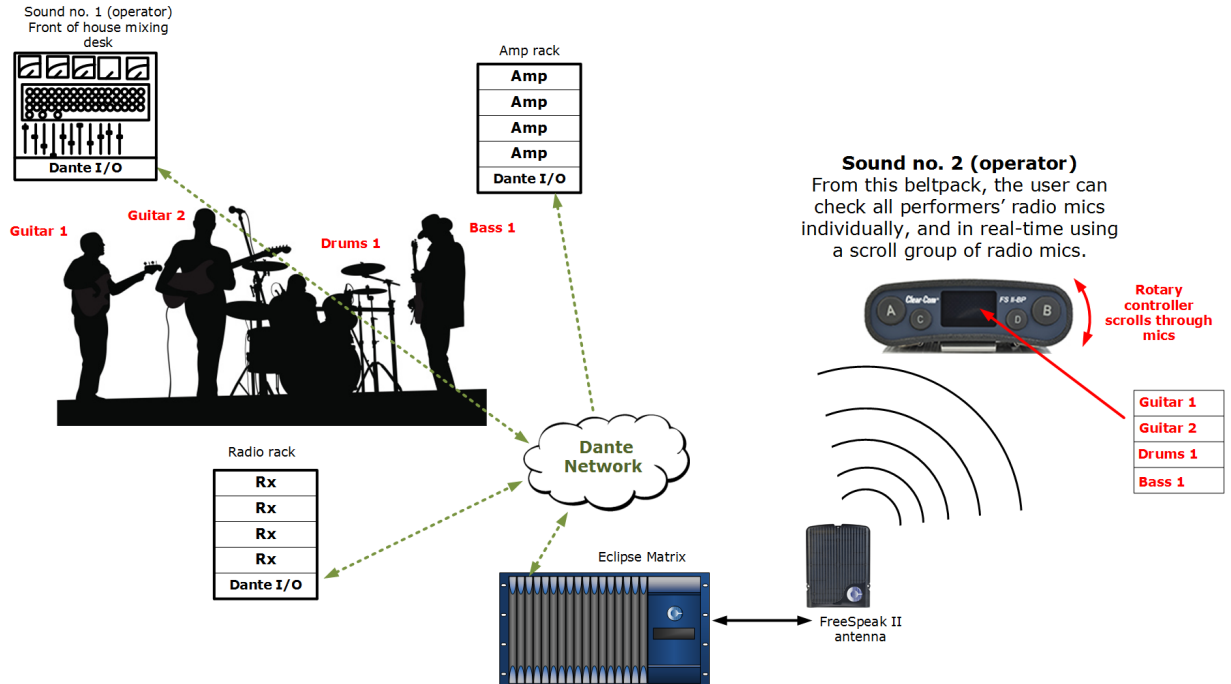

11.2 Using the E-DANTE64-HX Card

To route audio using an E-DANTE64-HX you must already have the Audinate Dante Controller installed on your PC (or similar device that can set up Dante routes). The Dante Controller can be downloaded from the Audinate website.

11.2.1 Install the E-DANTE64-HX Card on your Matrix and Connect Primary and Secondary Networks

Note: *The Primary network should always be installed and tested before the secondary network is set up. This is because the secondary network will be copied directly from the primary network, and it is not desirable to duplicate mistakes*

Always install the rear card in an interface card set before the front card. When installing the rear card, the matrix should be powered off. However, Clear-Com front interface cards are hot pluggable, there is no need to power off the matrix when removing or replacing the front section of the card.

See *Installing Interface Cards* in the Clear-Com matrix user guides for detailed instructions (available from the Clear-Com website).

1. Install the E-DANTE64-HX card.
2. Connect the primary network to the primary network switch on the E-DANTE64-HX card using RJ45 Ethernet or Fiber cable.
3. Connect the secondary network to the secondary network switch on the E-DANTE card (if you are using a secondary network).

Note: *The card can be used with an RJ45 Ethernet or a Fiber Ethernet connection for either network. Valid combinations are:*





Primary	Secondary
RJ45	RJ45
RJ45	Fiber
Fiber	Fiber
Fiber	RJ45

If you try and mix RJ45 and Fiber on one network the audio will stop working.

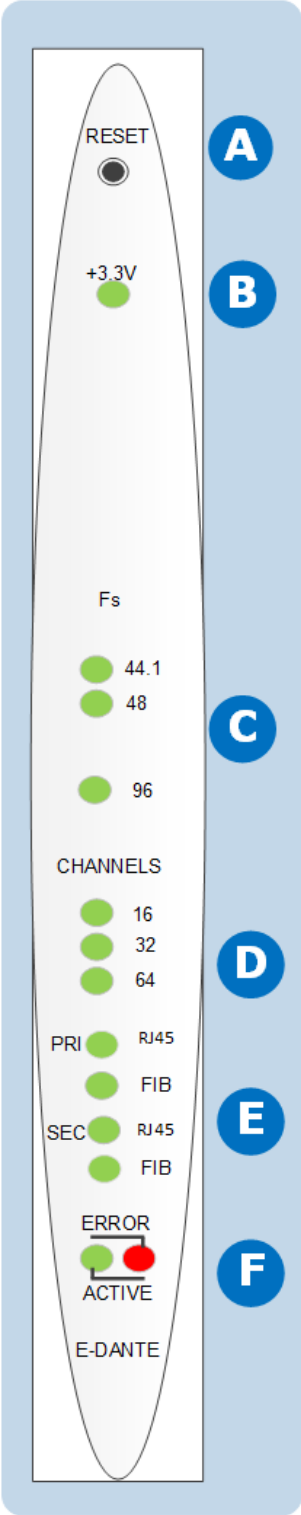
Note: *Network configuration including IP addressing is managed by the Dante software rather than EHX. See [Network Configuration on page 145](#) for more details.*

11.3 E-DANTE64-HX Front Panel Lights and Controls







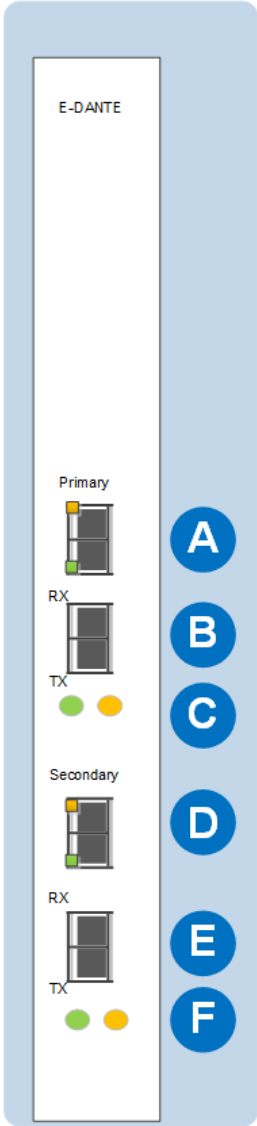

Feature	Description
	<p>Reset button</p> <p>Pressing the Reset button causes the card and all links to momentarily stop their current activity and to restart. The flashing green Active light goes off when the reset starts and comes back on when the reset is complete.</p> <p>During the reset, configuration information downloads to the card from the matrix CPU card.</p> <p>Note: <i>The reset button is slightly recessed. A tool such as a bent paper clip is needed to press this button.</i></p>
	<p>+3.3 Volt Power Supply LED</p> <p>Indicates that power is being supplied to the card.</p>
	<p>Sample rate (Sampling frequency)</p> <p>A green LED indicates the current sampling rate of the E-DANTE64 device. The sample rate is set in the Dante Controller (Routing Screen>double click Device>Device Config>New Sample Rate). Dante enabled devices on the same network must have the same sample rate, or they will not connect.</p> <p>Note: <i>A sample rate of 96KHz will limit the number of channels available on the E-DANTE64-HX card to 32.</i></p>
	<p>Channels</p> <p>This LED indicates the number of channels available on the card. This indicator is determined by sample rate. If the selected sample rate is 96KHz, 32 channels are available, not 64.</p>
	<p>Primary and Secondary network connection LEDs</p> <p>When lit, these LEDs show that the card is connected to a network switch or switches, either RJ45 or Fiber. The color of the LED indicates speed of connection. This network connection LED will flicker and flash to indicate network traffic.</p> <p>If RJ45: An amber LED indicates 100Mbps connection. An LED lit green indicates 1Gbps connection. Clear-Com does not recommend using less than 1Gbps in most circumstances, as 100Mbps will only support a small number of Dante channels. A Fiber connection is always 1Gbps and is always green.</p>

Feature	Description
	<p>Active LED</p> <p>The Active (matrix data) LED flashes green (1:1 at 1Hz) to indicate successful communication between the E-DANTE64-HX interface and the CPU card. This LED will flash twice as fast while a card is being upgraded and firmware is being installed (EHX firmware only, the light will stay as normal while Dante firmware is being installed).</p> <p>Error LED</p> <p>Possible error conditions:</p> <p>Expected networks not connected on back of card (See EHX Configuration User Guide for redundancy options for this card).</p> <p>Card configuration does not match card or cards installed. The name on a card in a card slot does not match the name the EHX software has for that slot.</p> <p>During boot up, the Active and Error LEDS flash rapidly until the boot sequence is completed.</p>

11.4 E-DANTE64-HX Rear Panel Lights and Controls



Note:
Green LED = 1 Gbps connection
Amber LED = 100 Mbps connection

Feature	Description
	<p>Primary network connector RJ45</p> <p>See Note below.</p>
	<p>Primary network connector Fiber</p> <p>You will install a Clear-Com SFP/Mini-GBIC in this slot. See Specifications section for details.</p>
	<p>Primary Fiber connection LEDs</p> <p>The green LED indicates that the network (Primary or Secondary) is successfully connected. Amber LED is not in use.</p>
	<p>Secondary network connector RJ45</p> <p>See Note below.</p>
	<p>Secondary network connector Fiber</p> <p>In this slot you will install a Clear-Com SFP/Mini-GBIC. See Specifications section for details.</p>
	<p>Secondary Fiber connection LEDs</p> <p>The green LED indicates that the network (Primary or Secondary) is successfully connected. Amber LED is not in use.</p>

Note: If using RJ45 cable, the small LEDs on the connector indicate connection speed. **Green** indicates 1Gbps connection. **Amber** indicates 100Mbps connection. Clear-Com does not recommend using less than 1Gbps in most circumstances, as 100Mbps will only support a small number of Dante channels. The Fiber connection LED always lights green.

If you try and use both RJ45 and Fiber connectors at the same time on one network the audio will stop working.

11.5 Network Configuration

IP addressing is handled by the Dante software:

Automatic network configuration

A Dante-enabled device connected to a network will automatically setup its own network configuration, including its IP address.

If the network has a DHCP server, which may be the case for installed networks, it will receive its IP configuration using the standard DHCP protocol.

On a network without a DHCP server, which may be the case for temporary or smaller networks, the Dante-enabled device will automatically assign itself an address using link local protocols, in the same way PCs and printers often do.

See *Audinate Dante Controller User Guide*, 2016 Audinate Pty Ltd.

Note: *DHCP is the preferred method of IP allocation when using Dante.*

The E-DANTE64-HX card IP address is set by the Dante controller. This IP address is different from the main Eclipse Matrix (LAN) IP address.

Clear-Com recommends that the Eclipse Matrix (LAN) IP address uses a fixed/static IP address.

11.6 Installing a Replacement or Backup Card

When you remove an E-DANTE64-HX interface card from the Clear-Com matrix rack, any channel subscriptions (connections) that have been made in the Dante Controller are removed as they are stored on the card. You need to re-apply these subscriptions in the Dante Controller using the Load Preset function for the backup card.

1. Remove the front E-DANTE64 card from the matrix rack by gently opening the side ejector tabs and pulling the card out of its slot.
2. Carefully insert the new card and push it home, closing the side ejector tabs to secure it in the matrix.
3. Open the Dante Controller and apply the required preset configuration (File>Load Preset).

The new card may have pre-existing configuration on it. Use the Dante controller to make sure that the configuration is as you want it.

At this point, you can either use the card immediately, or you can check that audio is flowing as required and keep the replacement card aside for use when needed.

Note: Changing the E-DANTE64 rear card requires a power down of the matrix. The front card can be replaced without power-down (hot plugged).

11.7 Upgrading your E-DANTE64-HX Card

Upgrades for your E-DANTE64-HX card are available for both EHX and Dante firmware and are available from your Clear-Com representative.

The upgrade process for each of the two modules on the card (EHX and Dante) is different. The two processes are outlined below.

Note: When upgrading your E-DANTE64-HX card, only use the Clear-Com supplied upgrade files for both.

(A: EHX) ClearCom - App, Boot, DSP, FPGA: xxxxxx.FWC files

(B: Dante) ClearCom [Brooklyn]: xxxxxx.dnt file.

To check if your firmware is up to date, open the Firmware Report in EHX:

1. In the EHX software, navigate to the **Layout** tab.
2. Right-click on the required matrix and select **Firmware/Firmware Report**.



11.7.1 Upgrade EHX E-DANTE64 Firmware

1. In the EHX software, navigate to the **Layout** tab.
2. Right-click on the matrix to be upgraded and select **Firmware > Update Firmware > Card**.
3. Navigate to where the E-DANTE64-HX upgrade file is stored and click to upload.

There are 4 possible upgrade file types.

Upgrade file type	Approximate upgrade time/notes
App.FWC	2 min. This is the most common file to upgrade and is usually labeled 'Clearcom'.
Boot.FWC	1 min.
DSP.FWC	3 min. Reset card on front panel after upgrade.
FPGA.FWC	16 mins.

While the E-DANTE64 card is being upgraded with EHX firmware, the active light (green) on the front of the device will flash at double its usual speed and the error light (red) will show. The card is ready for use when the error light is off and the status light has returned to a steady 1Hz pulse.

The screenshot shows the EclipseHX software interface. On the left, there is a navigation pane with options like System, Layout, Monitoring, and Go Online (No Merge). The main area is divided into several sections: 'Discovered Matrices' showing a list of matrices with their configurations and status (e.g., 'No Configuration', 'CIRA Pico 2', 'Hardware Eng', 'CIRA Omega 1', 'CIRA Omega 2'); a 'Key' section with color-coded buttons for Trunk, IP Trunk, PiCo Link, E1 Trunk, T1 Trunk, and Fiber Trunk; and a 'Tech Pubs matrix' section with a 'New Configuration' button and a 'Config Manager' button. A callout box labeled '1. Layout tab' points to the 'Layout' button in the navigation pane. Another callout box labeled '2. Right click on matrix. Select Firmware>Update Firmware>Card. Navigate to the upgrade file (.FWC) and click to upload.' points to the 'Tech Pubs matrix' section.

Note: The EHX component of the E-DANTE64-HX card is both **centrally** upgradable (you can upgrade the E-DANTE64-HX through the matrix, using EHX) and **locally** upgradable, using Xilinx software, a PC and a Xilinx download cable. The process is the same as for a Clear-Com MADI card.

For more information, see the *Eclipse HX Upgrade Guide* and refer to the section on MADI.

11.7.2 Upgrade Dante Firmware

Before updating the Dante component of your E-DANTE64-HX card, you must first download the Dante Firmware Update Manager from the Audinate website.

Open the Dante Firmware Update Manager and follow the instructions on the screen.

The Dante firmware upgrade file (usually labeled 'Brooklyn') has a **.dnt** extension.

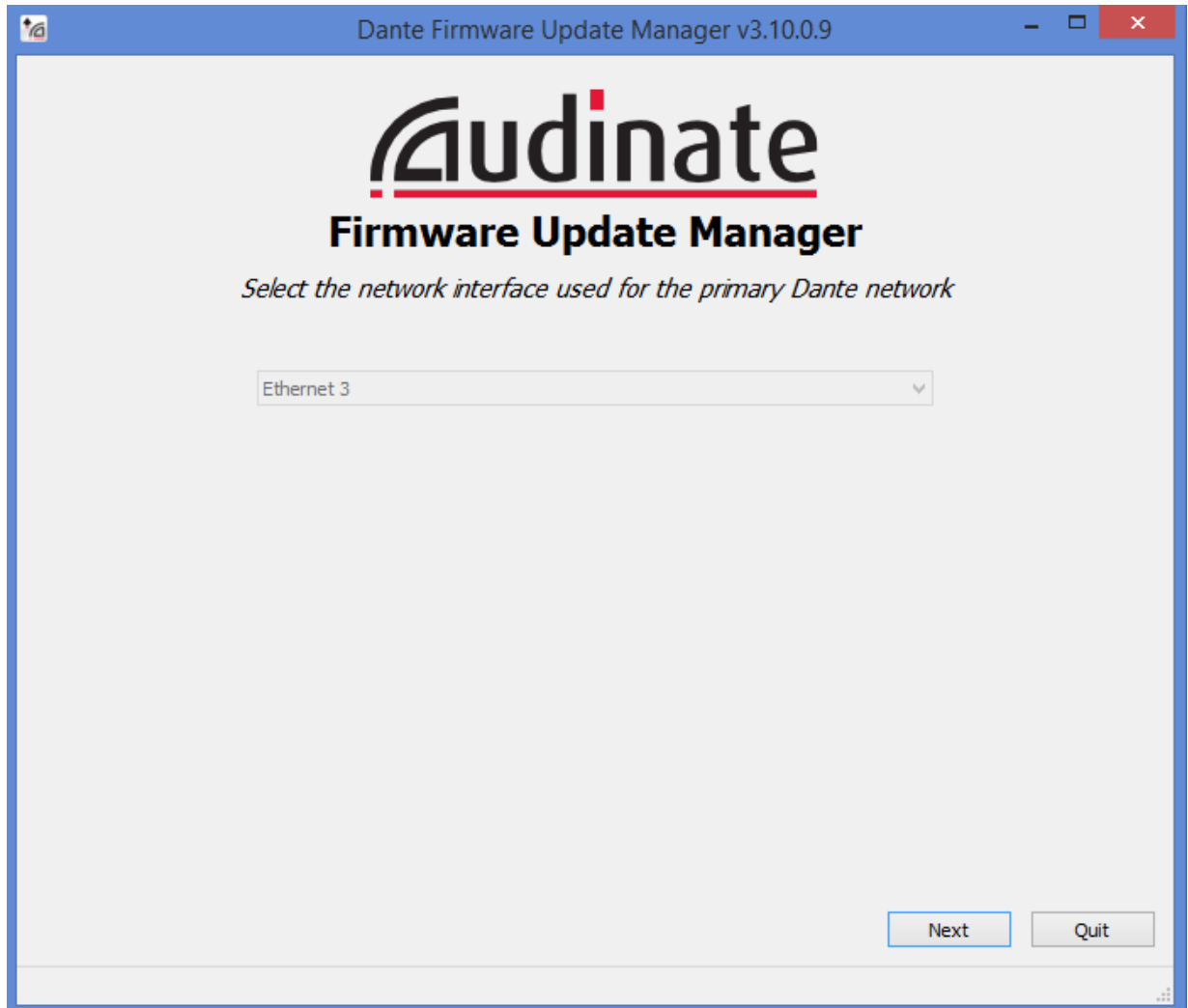

Notes: *Disable any firewalls before upgrading the E-DANTE64-HX combined Brooklyn file via Dante Firmware Update Manager.*

When upgrading firmware for the Dante component, the status light on the front of the E-DANTE64-HX card will not change.

11.8 Troubleshooting: Sample Rate

Dante devices **must** be set to the same sample rate for audio to pass between them. Set sample rate for all devices in the Dante Controller. Right-click on device icon in the **Routing** page to open **Device View>Device Config**.

11.9 Troubleshooting: I Need to Find the E-DANTE64-HX Card's IP Address

In most cases the E-DANTE64-HX card will be discovered by the Dante Controller and be available for configuration in the controller's **Routing** page.

Cards that have been 'misplaced' and are not visible in the routing screen are those that have been configured with a static IP address that falls outside the subnet which the PC hosting the controller is on.

To remedy this you will need to:

- Find the card IP address in the Dante controller
- Make sure both devices, the PC hosting the controller and the E-DANTE64-HX card are on the same subnet
- Access the card and reallocate IP as required.

11.9.1 Find the Device IP Address

If the E-DANTE64-HX card is on a different subnet to the PC, the card will not be visible in the routing screen, but will be available under **Device Info** where it will show with a red highlight.

Click to see device IP address

The screenshot shows the Dante Controller Network View interface. The 'Device Info' tab is active, displaying a table of devices. The device 'AIC128-D-080690' is highlighted in red. A callout box points to the device name.

Device Name	Product Type	Product Version	Device Lock	Primary Address	Primary Link Speed	Secondary Address	Secondary Link Speed
AIC128-D-080690			N/A				
Amp-FOH	IG-88	4.0.3	<input type="checkbox"/>	10.10.60.52	100Mbps	N/A	N/A
Elliot-PC2	Dante Via	1.1.0.4	<input type="checkbox"/>	10.10.60.66	1Gbps	N/A	N/A
FOH-Desk	Nexus-10	1.2.30	N/A	10.10.60.95	1Gbps		Link down
lethe			N/A				
Rahuls-PC			N/A				
Stagebox-1	Mechastreisand	7.6.5	<input type="checkbox"/>	10.10.60.62	1Gbps		Link down
whos-pc-is-this	DvsWin	3.10.0.7	<input type="checkbox"/>	169.254.71.184	1Gbps	N/A	N/A
Windows-PC			N/A				
xiangxingzixiangxingzixiangxing			N/A	10.10.60.89	1Gbps	N/A	N/A

At the bottom of the interface, there are status indicators: P: S: Multicast Bandwidth: 0 bps Event Log: Clock Status Monitor:

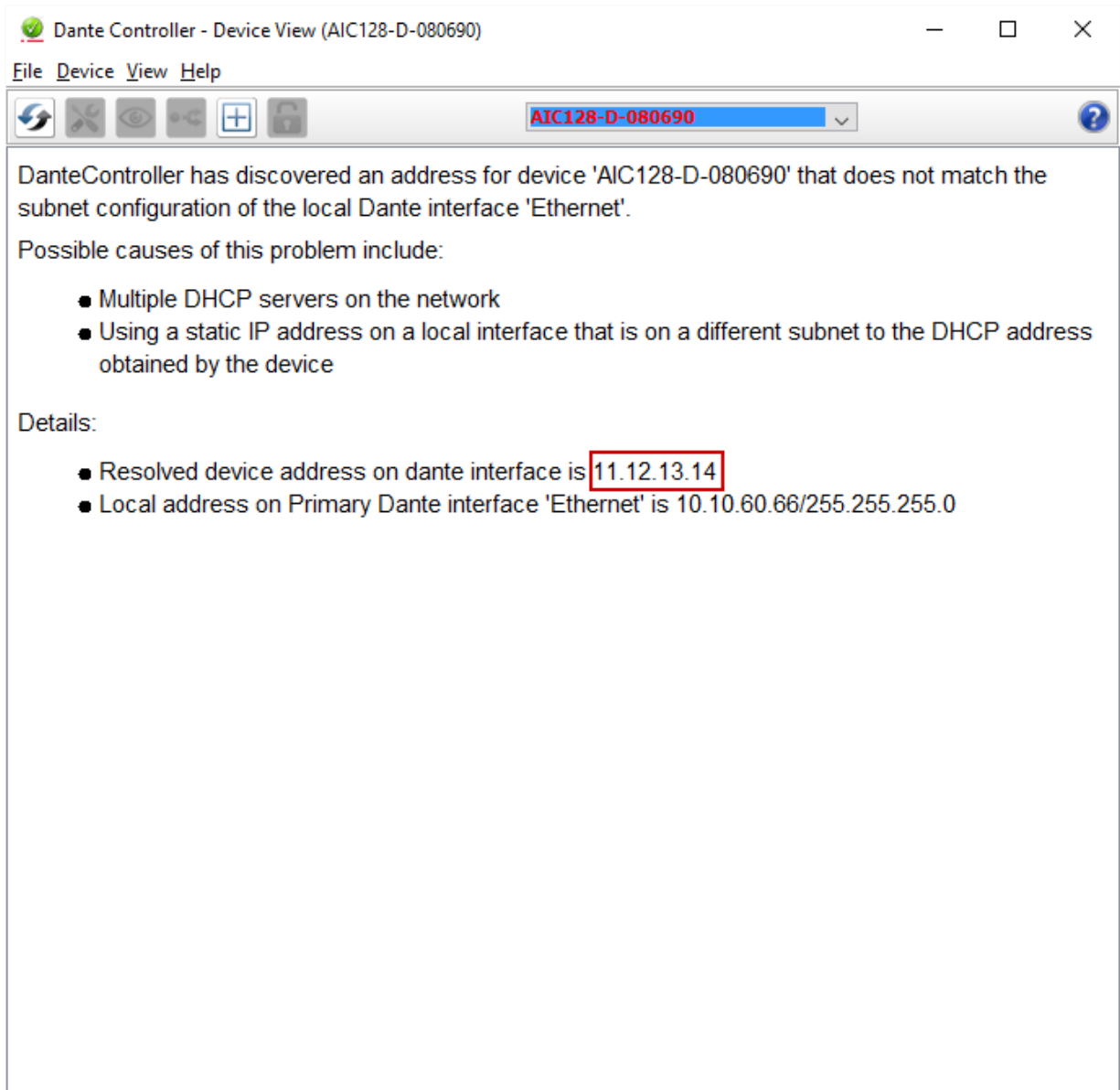

11.9.2 Make Sure Both Devices Are On the Same Subnet

In order to be able to configure the E-DANTE64-HX card as usual, you must make sure that the PC hosting the controller is in the same IP range (subnet) as the card.

Once you have reset the IP address of the PC accordingly, the 'misplaced' E-DANTE64-HX card will be visible in the routing screen for configuration. From this point you can manually reset the IP address of the E-DANTE64-HX card as required.

11.9.3 Reset the IP Address of the Dante Controller

Set the IP address in the Network Config screen of the Dante Controller.

Note: *Dante devices use DHCP by default, and in most cases this is the recommended IP selection method.*

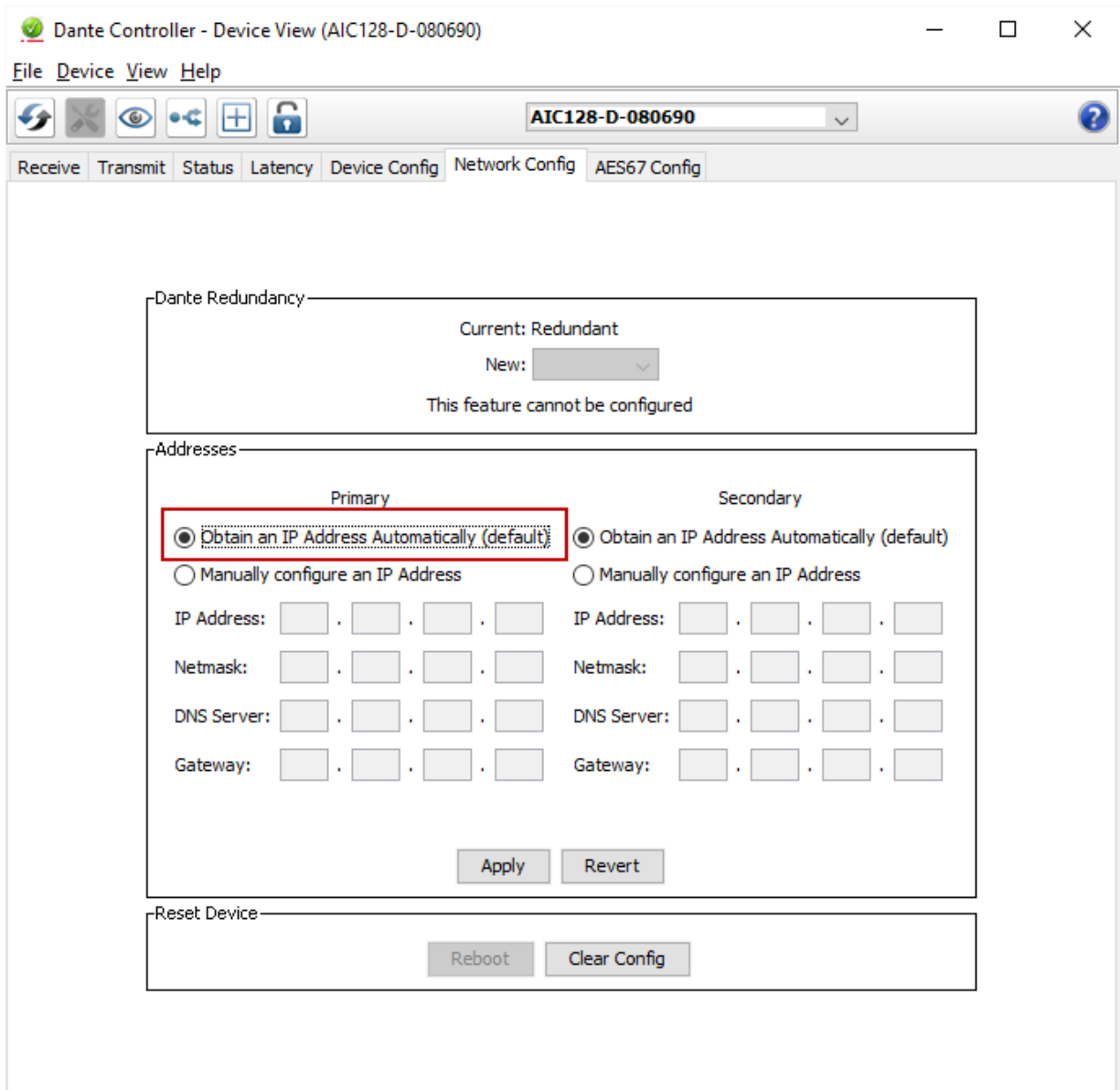

11.9.4 Link-Local

The link-local IP range is a special case (169.254.1.0 – 169.254.254.255).

The Dante Controller will NOT see an E-DANTE64-HX card with a link-local IP address if the PC hosting it is not set to the link-local IP range also. In this case, you need to change the PC's IP address to a value in the link-local range before you can access and configure the card.

For more information see the Audinate website: <https://www.audinate.com/faq/how-can-i-locate-dante-device-static-ip-address-unknown-subnet> (last accessed 16th February 2017).

11.9.5 AES67 Guidelines

When connecting devices to route AES67 audio streams with your E-DANTE 64 card, the following general principles should be noted:

- AES67 uses IEEE1588-2008 Precision Time Protocol (PTP) to ensure synchronization between devices. All networked devices, including your network switch must support this standard.
- You need to disable any Energy Efficient Ethernet (EEE) switches, as these will disrupt the synchronization of audio streams.
- All networked devices need to support multicast routing. The Dante system defaults to multicast when routing AES67 streams.
- Multicast routing uses the Class D range of IP addresses (224.x.x.x – 239.x.x.x). For AES67 streams, chose an IP range that does not conflict with other network traffic. Consult your network administrator if necessary.
- It is recommended that Internet Group Management Protocol (IGMP) snooping is enabled on your network switch. This will avoid the possibility of flooding your network.
- Dante uses Session Announcement Protocol (SAP) to discover devices on a network. If any of your devices do not support SAP, the Dante Controller will not be able to see them. In this case, you need to use a SAP conversion tool, such as the free Ravenna-2-SAP converter available from the Ravenna website, <https://www.ravenna-network.com>

Configuration for devices that do NOT support Session Announcement Protocol (SAP)

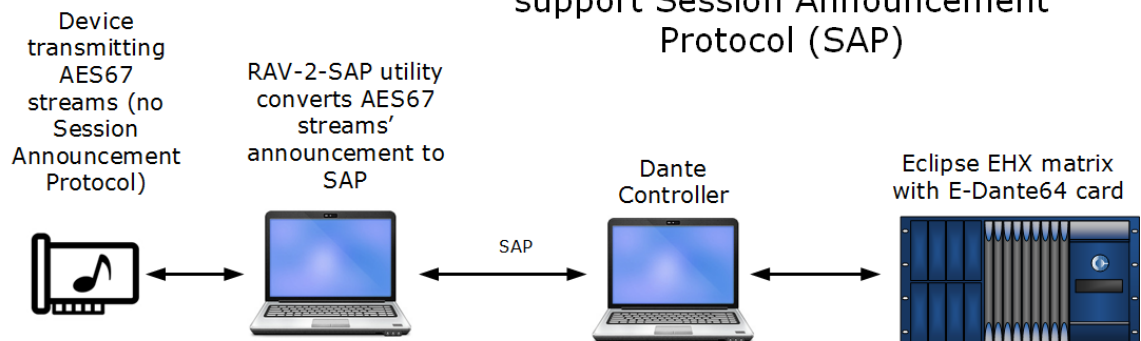

Once Dante can see the audio streams they do not go via the RAV-2-SAP utility.

From the Dante Controller, enable AES67 streams and create flows in the **AES67 Config** page. When this is done a virtual transmitter (blue) can be seen in the **Routing** page and the audio can be routed in the usual way.

12 E-IPA-HX High Capacity IP to Matrix Card

The E-IPA card is a high capacity multi-protocol card:

- IP connections
- E1 connections (when in E1 mode, the card no longer works with IP).

It provides up to 64 connections. In IP mode, these can be made up of a combination of up to 64 IP ports or FreeSpeak II wireless beltpack connections (according to license). In E1 mode you can have up to 10 FSII transceivers, and 50 beltpacks.

In IP mode, the card offers:

- IVC functionality and AES67 connectivity for Clear-Com FreeSpeak II IP Transceivers (IPTs) and V-Series panels.
- It also provides AES67/SMPTE 2110 connectivity 3rd party.

IVC-32 functionality (V-series panels, Directs, LQ, and Agent-IC) runs at the same time as FSII beltpacks.

Note: *You must have a 32 port license on your E-IPA card in order to put it into E1 mode.*

Note: *FSII Splitter daisy-chaining is not available when using E1 with an E-IPA card. The connection between matrix and splitter must be Fiber.*

The E-IPA-HX card requires EHX software 10.0 and above.

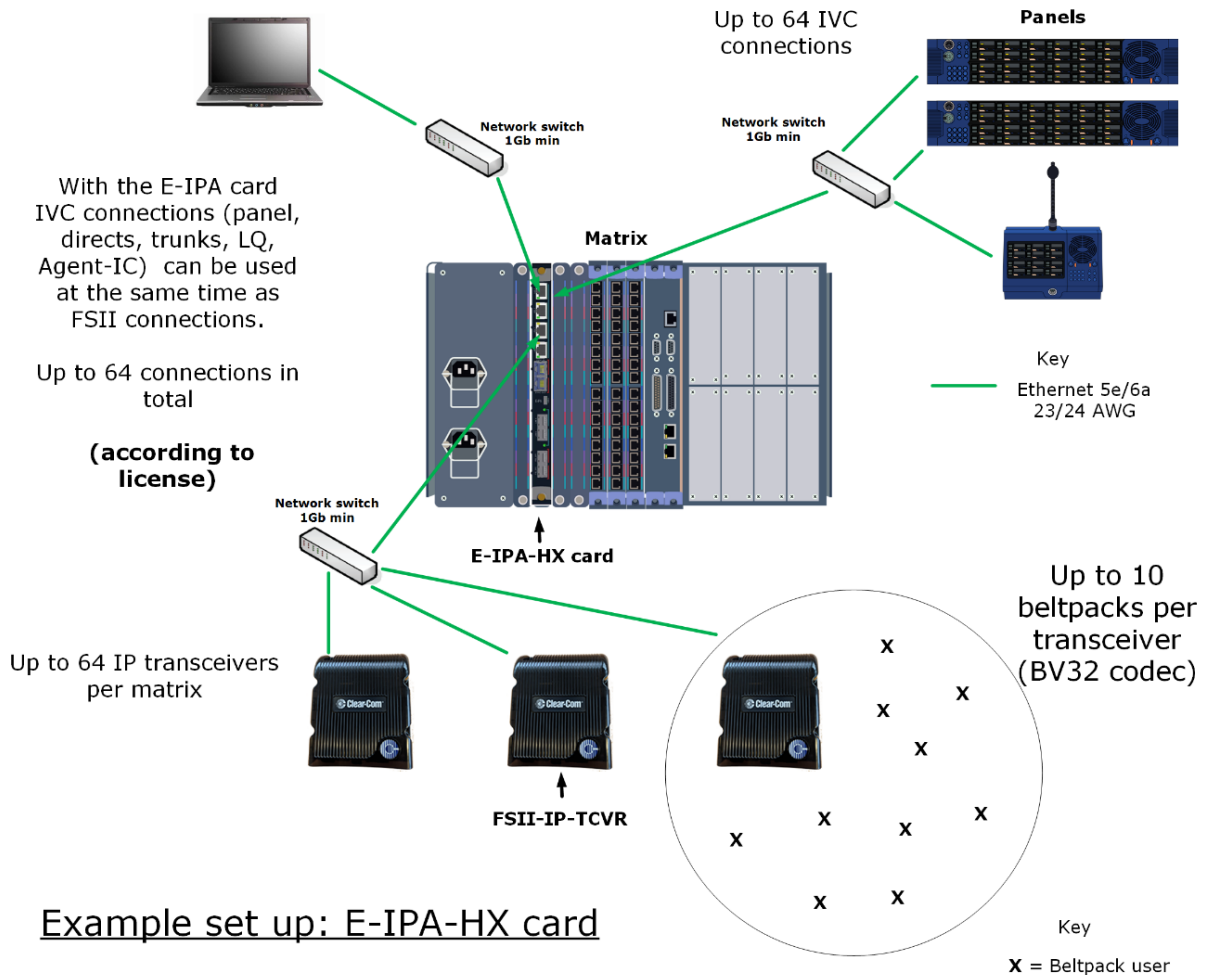

12.1 Adding an E-IPA-HX Card (Automatic Discovery)

The E-IPA-HX card is automatically discovered when:

- You select the **Discover Hardware** option after the Matrix is placed on the **System Layout** from the discovery pane.
- You right-click a matrix on the **System Layout** screen, and then select **Configuration > Create New Configuration > Discover Hardware**.

12.2 Licenses

The card operates on a license basis.

There are two types of license available for an E-IPA card:

- Port licenses (up to 64)
- Feature licenses

For both types of license, you have the option to purchase additional licenses to upgrade a card you already have.

For how to obtain and install licenses see the ***E-IPA Card Licensing Guide***.

Port licenses

Purchase your ready licensed card in increments of 16 ports.

Number of ports	Part number
16 ports	E-IPA-16-HX (1 x 16)
32 ports	E-IPA-32-HX (2 x 16)
48 ports	E-IPA-48-HX (3 x 16)
64 ports	E-IPA-64-HX (4 x 16)

Purchase an upgrade to your current card port capacity by 16 ports

16 additional ports	E-IPA-UG-16-HX
---------------------	----------------

When you install a new card and use the **Detect New Hardware** feature in the EHX software, the software automatically detects the number of ports that are licensed on the card. You can also select the appropriate number of ports in **Card Properties**.

The front lens of your card will always show how many ports you have licensed on that card.

Feature licenses: SMPTE 2110/AoIP channels

Feature licenses must be purchased additionally to the port licenses and are available as shown below.

Feature license:

Number of channels	Factory fitted licenses	Customer self-fit licenses
8	E-IPA-AoIP-8-HX	E-IPA-AoIP-ADD-8-HX
16	E-IPA-AoIP-16-HX	E-IPA-AoIP-ADD-16-HX
32	E-IPA-AoIP-32-HX	E-IPA-AoIP-ADD-32-HX
48	E-IPA-AoIP-48-HX	E-IPA-AoIP-ADD-48-HX
64	E-IPA-AoIP-64-HX	E-IPA-AoIP-ADD-64-HX

Feature licenses: SIP channels

Number of channels	Customer self-fit licenses
8	E-IPA-SIP-Add-8-HX

12.3 Card Capacity

- 64 ports max
- 64 feature licenses max
- 64 AoIP streams max

Note: Streams are not licensed in EHX

Your card port capacity is consumed by these port types:

- V-series panels
- LQ
- LQ SIP
- Agent-IC
- Directs
 - AoIP stream
 - AoIP channel
 - IVC
 - LQ
- Trunks
 - AoIP
 - IVC
 - LQ
- Wireless beltacks

Note: IP transceivers do NOT consume a port (beltacks do).

Your stream capacity is consumed by these connection types:

- Direct AoIP stream (1)
- IP transceiver (1)
- Trunk AoIP (1 – 4 streams, depending on how many channels are grouped with this trunk).

EHX displays how many streams are in use per card. For example, if you have a 16-port card license and this card is configured to connect 8 beltpacks and 8 IrisX(also applicable to V-Series Iris) panels (AoIP), then a maximum of 56 IPTs can be connected. This is because 8 AoIP streams are already being used. If you are nearing the stream capacity of your system, consider switching your IrisX panels into IVC mode to free up some extra streams.

Concert is NOT supported on the E-IPA-HX card.





12.3.1 How many E-IPA Cards in a Clear-Com Matrix?

- Clear-Com Median matrices: up to four E-IPA cards per matrix
- Clear-Com Delta matrix: up to three E-IPA cards per matrix
- Clear-Com Delta Lite matrix: up to one E-IPA card per matrix

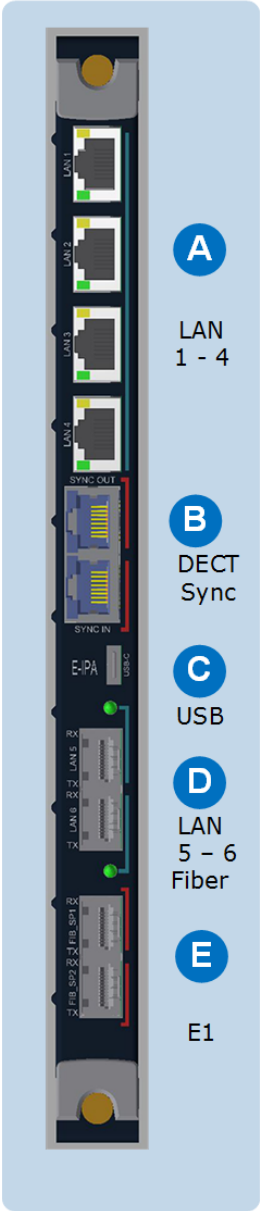
This is an estimate for general guidance. For a more exact calculation, refer to the Eclipse HX System Power Calculator (Excel spreadsheet) that comes with your EHX firmware. You can find this spreadsheet in the **Documents** folder on the firmware DVD or USB.

12.4 E-IPA-HX Rear Connectors









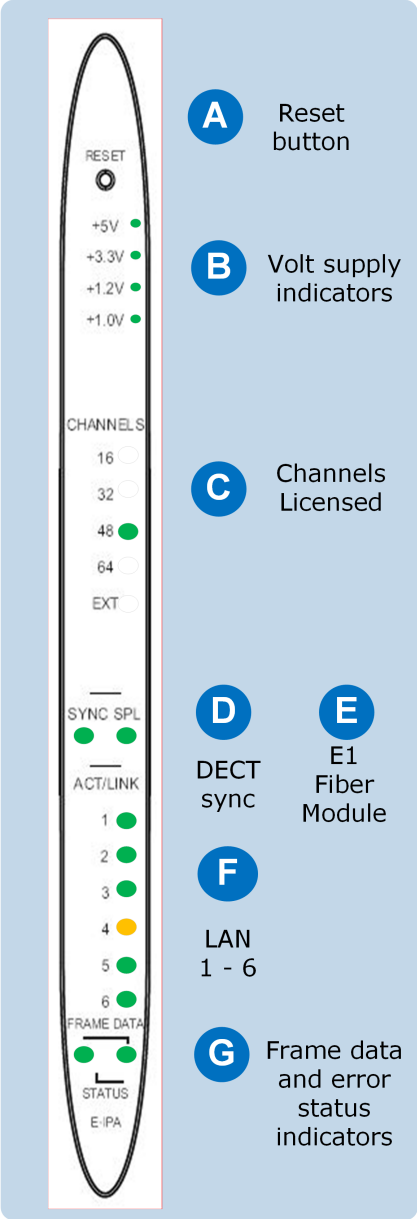

	<p style="text-align: center;">RJ45 LAN ports 1 – 4</p> <p>These can be used for: Clear-Com panels, directs, trunks, LQ, Agent-IC. They can also be used for FSII IP Transceivers. One of the ports can be designated as an ADMIN port and used for maintenance. The functionality of these ports is configured in the EHX software.</p>
	<p>RJ45 DECT sync ports</p> <p>These connectors can be used when you are using two separate DECT systems in the same area. Connecting the systems with the DECT sync connector ensures that all connected clocks are synchronized together. This avoids clashes when many DECT devices are in use in the same RF space.</p> <p>DECT sync can be established between matrices, bases and third party systems.</p> <p>See DECT Sync Pinouts in the FreeSpeak II User Guides.</p>
	<p>USB C</p> <p>USB maintenance port.</p>
	<p>LAN ports 5 and 6. Fiber</p> <p>As with ports 1 – 4, the functionality of these ports is configured in the EHX software.</p> <p>Use this slot to install an SFP/Mini-GBIC.</p>
	<p>E1 Fiber ports Use these ports to connect IP transceivers when the card has been configured to E1 mode.</p> <p>Install fiber modules according to existing network (single or multi-mode fiber):</p> <p>Part numbers:</p> <ul style="list-style-type: none"> • Single mode: 480261Z • Multi-mode: on request

Note: The E-IPA card has six Media Access Control (MAC) addresses. These are printed on the card.

12.5 E-IPA-HX Front Lens Indicators



	<p style="text-align: center;">Reset button</p> <p>This button is recessed to avoid accidental reset. Use a paperclip, or some appropriate item to reset the matrix.</p>
	<p>Volt supply indicators</p> <p>Normally, all these lights are lit, showing that the correct voltage is being supplied to the various card components.</p>
	<p>Channels licensed</p> <p>This indicates how many channels are licensed to the card. EXT is for future use.</p>
	<p>DECT sync</p> <p>This LED lights when a DECT-in sync connection is fitted to the card.</p>
	<p>E1 fiber connection to FSII splitter</p> <p>When lit, this shows a connection to an FSII splitter (for future use).</p>
	<p>LAN ports 1 – 6</p> <p>1 – 4 RJ45 LAN connections 5 – 6 Fiber LAN connections</p> <p>These lights show active links. They flicker and flash to indicate network traffic.</p> <p>An amber LED indicates 100Mbps connection. An LED lit green indicates 1Gbps connection. For FS II, Clear-Com does not recommend using less than 1Gbps in most circumstances, as 100Mbps only supports a small number of channels. A fiber connection is always 1Gbps and is always green.</p>

	<p style="text-align: center;">Reset button</p> <p>This button is recessed to avoid accidental reset. Use a paperclip, or some appropriate item to reset the matrix.</p>
	<p>Frame data</p> <p>The Active (matrix data) LED flashes green at 1Hz to indicate communication between the E-IPA-HX card and the CPU card. This LED flashes twice as fast while a card is being upgraded and firmware is being installed.</p> <p>Status light Error LED</p> <p>Possible error conditions:</p> <ol style="list-style-type: none">1. Solid red light. Hardware fault (major issue). <p>To diagnose other errors, see the EHX software event log.</p>

13 Maintaining the Eclipse HX-Median

The Eclipse HX-Median matrix system connects a complex network of microprocessor controlled devices.

Due to the complexity of the system, field service should be limited to isolating a problem to the specific circuit board that may be causing the problem. Once the circuit board has been identified, it can be either repaired or replaced.

Note: For an overview of the Eclipse HX-Median, see [Overview on page 10](#)

	<p>Servicing instructions are for use by qualified personnel only. To reduce the risk of electric shock, do not perform any servicing other than that described by this guide, unless qualified to do so. Refer all servicing to qualified service personnel.</p>
---	---

13.1 Routine Maintenance Recommendations

13.1.1 Cleaning the Matrix Frame

Because the matrix has moving air in it, the entire matrix should be cleaned at least once a year. To clean the matrix, shut off AC power, remove all cards, and use compressed air to remove any dust buildup in the matrix itself. Clean all cards with a brush to remove dust buildup.

	<p>Care should be taken not to induce a static discharge in the cards. Use of a grounding wrist strap is recommended. If a grounding wrist strap is not available, touch an unpainted metal surface on the matrix chassis periodically to neutralize static electricity.</p>
---	--

13.1.2 Spare Parts

To facilitate quick repair of the system with minimum downtime, Clear-Com recommends keeping the following spare system components in good working condition at all times:

- One CPU card.
- One interface card.
- One Euro Cassette power supply module of the type fitted to the matrix.
- One of each type of intercom panel in the system.
- One of each type of interface in the system.

13.2 Fail-Safe Modes

High reliability is one of the main objectives of the Eclipse HX-Median system design. The following features of the system minimize the effects of a component failure.

13.2.1 Dual Power Supplies

The Eclipse HX-Median matrix includes two Euro Cassette power supply units. One power supply unit can power an entire matrix; the second unit provides a backup in case of an equipment failure.

In addition, the two supplies have separate IEC connectors to AC mains power, and are designed for completely automatic and transparent changeover between supplies in the event of a power failure on one of the AC branches.

	<p>To reduce the risk of electric shock, plug each of the power cords to separate branch circuits with different service ground.</p>
---	--



Disconnect Power Sources

The power supplies contain an over-temperature sensor that is connected to both an audible alarm and a warning light, giving the system operator the necessary forewarning to diagnose and correct any power anomalies while the system remains operational.

If any individual power supply fails, an alarm can be issued to a remote location to alert operators that part of a power supply has failed. The failure of a single supply will issue an alarm, but the Eclipse HX-Median system will continue to operate normally, powered by the second supply.

13.2.2 Hot Patchability

The **front panels** of CPU cards and interface cards (not **rear panels**), and all Euro Cassette power supplies are **hot patchable**— that is, they can be plugged in or removed from the matrix while the power is on, and they will be neither damaged, nor will they cause damage to the system.

In addition, the system smoothly incorporates a newly added card. Sometimes re-inserting a CPU card can reset the matrix. Replace CPU cards during maintenance down times if possible.

13.2.3 Onboard Processors

If one analog port interface malfunctions, the malfunction will normally affect only the panels connected to that analog port interface. The malfunction should not affect any other cards or panels in the system. In all cases, removing a faulty card affects only the devices connected to that card.

13.2.4 Fail-Safe Communication

In the event of a CPU card failure, the second CPU card takes over operation of the system, while the first card is repaired or replaced.

13.3 Troubleshooting

When attempting to identify the cause of the trouble, it is helpful to begin with the two most basic areas which cause malfunctions:

- The flow of electric current from the power supplies to the cards.
- The flow of data between the program software, the circuit cards, and the attached audio devices.

13.3.1 Troubleshooting Power Supply Problems

Electric current in the matrix starts at the power supplies, travels through the matrix's backplane connectors, and then travels to the circuit cards themselves. When power-supply problems occur, those three areas—the power supplies, the backplane connectors, and the circuit cards—should be explored to identify where the trouble is occurring. Solving power-supply problems starts with identifying the specific component causing the problem.

The matrix's backplane connectors are part of the matrix's infrastructure and are not serviceable by field personnel. If it is determined that a problem is in the matrix's backplane connectors, the matrix must be returned for repair. Backplane connector malfunctions are rare, but should be considered as possibilities.

Power supply lights on a component

A lit power-supply light on a component indicates that the matrix's electric current has traveled successfully to that component and is powering the component. For example, if the power-supply lights on the CPU card are lit, the electric current has successfully traveled from the matrix's power supplies to the CPU card.

If a power-supply light is not lit on a component, the electric current has not reached that component for some reason. Knowing where the current has stalled helps to identify the component that needs repair.

For example, if all of the power-supply lights on all cards do not light, the electricity supply may have given out either in the power supplies themselves or in the matrix's backplane connectors.

A faulty connector on the backplane, or a crack in the backplane can cause all of the matrix's power-supply lights to go out because the path on which the electric current is traveling has been blocked.

This is a rare problem, but one to consider as a possibility. Repairing the problem in this case would involve determining whether the problem is in the power supplies or the backplane connectors.

When a problem is identified in the power supplies or the circuit cards, the suspect component can be replaced with a properly functioning component to see if the problem is repaired.

Example power supply issues

Problem: One or more power supply lights are unlit on one interface card.

Before repairing or replacing card, try to determine where the problem is occurring. One or both of the following actions can be tried:

Action 1: Take the bad card out of the matrix, and insert it into a known good slot in the matrix.

If the power supply lights still do not illuminate, the problem is probably in the card itself. Repair or replace the card.

If the power supply lights illuminate, the problem may be in the matrix's backplane connectors, which carry electric current from the power supplies to the cards. The matrix can be returned to Clear-Com for investigation or repair. In the meantime, another matrix can be substituted for the damaged one.

Action 2: Take a known good card, and insert it into the slot.

If the power supply lights illuminate, the problem is probably in the card. Repair or replace the card.

If the power-supply lights do not illuminate, the problem may be in the matrix's backplane connectors, which carry electric current from the power supplies to the cards. The matrix can be returned to Clear-Com for investigation or repair. In the meantime, another matrix can be substituted for the damaged one.

Once the problem has been isolated to the card or the backplane, it is easier to take the next step which is to repair or replace the suspect component.

Problem: The power supply lights do not illuminate on any cards in the matrix.

In this situation, the most probable problem is that the matrix's power supplies are not sending out any electric current, since none of the cards are receiving power. Although less likely, the problem may be in the matrix's backplane connectors.

Action 1: Check the power supplies' alarm lights. If the power alarm lights are indicating a problem with the power supply, swap it out with a new power supply.

If this repairs the problem, the problem was in the power supply.

Action 2: If the problem persists even after the power supply has been replaced, the problem is in the matrix's backplane connectors.

Send the matrix back to Clear-Com for repair or replacement. In the meantime another matrix can be substituted for the damaged one.

Problem: The power supply lights do not illuminate on one of the two CPU cards.

When the system is functioning properly, the power-supply lights on both CPU cards illuminate. If the power-supply lights on a CPU card fail to illuminate, the problem may be with the card itself, or with the backplane connectors that carry the electric current from the power supplies to the cards. The backplane connectors are part of the infrastructure of the matrix and are not serviceable by field personnel.

Action 1: Swap the CPU cards. Put the first card in the second CPU slot and the second card in the first CPU slot. The problem will follow the card or the slot.

If the power supply lights do not illuminate on the bad card (the card with the lights out) when it is inserted in the other CPU slot, the problem is probably in the card.

If the power-supply lights on the bad card illuminate when the card is inserted in the other CPU slot, the problem is probably not in the card itself. The problem may be with the backplane connectors or power supplies.

Action 2: Check the power supplies' alarm lights. If the alarm lights are indicating a problem with the power supply, swap it out with a new power supply.

If this repairs the problem, the problem was in the power supply.

Action 3: If the problem persists even after the power supply has been replaced, the problem is in the backplane. Send the matrix back to Clear-Com for repair or replacement. In the meantime another matrix can be substituted for the damaged one.

Problem: The power supply lights are out on both CPU cards.

The problem may be with power supplies, since both cards appear not to be receiving power. Although less likely, the problem may be in the matrix's **backplane connectors**.

Action 1: Check the power supplies' alarm lights. If the alarm lights are indicating a problem with the power supply, swap it out with a new power supply.

If this repairs the problem, the problem was in the power supply.

Action 2: If the problem persists even after the power supply has been replaced, the problem is in the backplane.

Send the matrix back to Clear-Com for repair or replacement. In the meantime another matrix can be substituted for the damaged one.

13.3.2 Troubleshooting Data Issues

The other type of problem that can occur in the system is when data is not flowing properly between the program software, the circuit cards, and the attached panels and interfaces. A troubleshooting sequence in this situation would be to first check cabling, then reset the card or panel, then reset the entire system.

Analog port card (MVX-A16) Reset button

Resetting the analog port interface causes the configuration information for the interface and its attached devices to reload to the interface from the CPU card's operational memory (located in its microprocessor's RAM), thus clearing up any corruption of data that may have occurred in the analog port interface microprocessor. The interface and all connected panels and interfaces momentarily stop their current activity and restart. The reset button must be pressed for more than two seconds to take effect.

If the entire system is operating except for one analog port interface, or one or more panels connected to the interface, press the reset button for that interface only.

This button is slightly recessed from the front panel to prevent it from being accidentally pressed. A tool such as a bent paper clip is required to press this button.

CPU card Reset button

When the CPU card is reset by pressing its reset button, the card's non-volatile memory reloads all configuration information to the card's microprocessor. Resetting the card clears any corruption of data in the card's microprocessor. The card momentarily stops its current activity and restarts. The same system configuration that was active before the card was reset will be active after the reset.

The reset button is slightly recessed from the front panel to prevent it from being accidentally pressed. A tool such as a bent paper clip is required to press this button.

CPU card Full Reset button

Press and hold the full-reset button and simultaneously press the reset button for the system to perform a cold restart. All cards in the matrix reset regardless of any system preferences in the program software. All audio devices connected to the cards, such as panels and interfaces, reset as well.

When the cards and connected audio devices reset, they momentarily stop their current activity and restart. During this process configuration information is downloaded to the port cards and connected audio devices from the CPU card's microprocessor.

The same system configuration that was active before the card was reset will be active after the reset. The button must be pressed for more than two seconds for the reset to take effect.

Under normal operating conditions it is not necessary to perform a full reset. Technical personnel might perform a full restart if they believe that the CPU card is operating incorrectly as a result of corruption of the microprocessor's internal data or instruction sequence.

Example data issues

Problem: A port light on an analog port interface does not illuminate, although there is a panel attached to that port.

Action 1: Check the panel and the wiring leading to it.

Action 2: Check the Frame Data light. If there is no indication of matrix communication to this interface card while the other interface cards in the matrix are communicating, reset the interface card.

Action 3: Replace the interface cards.

Action 4: Replace the panel.

Problem: Audio sounds low or distorted from a panel.

Action 1: Check the matrix's currently active CPU card's power lights. If any of the lights are not lit, replace the card.

Action 2: Check the analog port input and output gain settings for the port in EHX.

Action 3: Check the panel's listen-level adjustment settings in EHX.

13.4 System Block Diagram

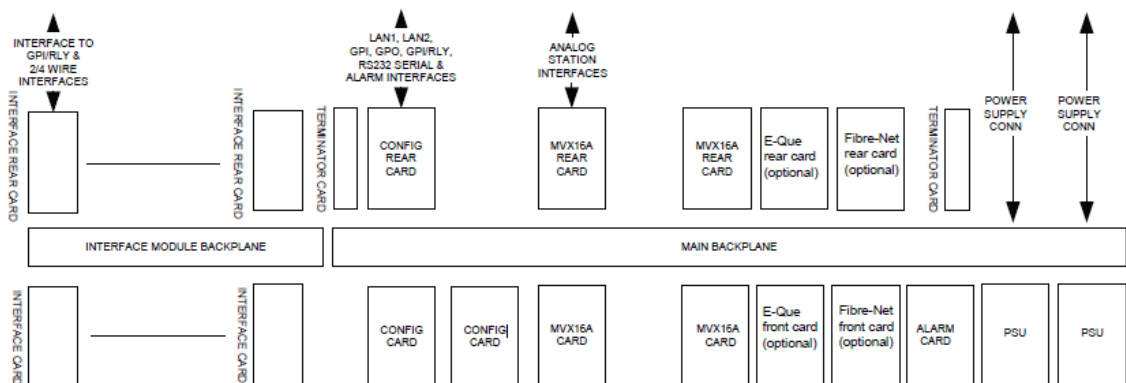

14 Regulatory Compliance

- Applicant Name: Clear-Com LLC
 - Applicant Address: 1301 Marina Village Pky, Suite 105, Alameda CA 94501, USA
 - Manufacturer Name: HM Electronics, Inc.
 - Manufacturer Address: 2848 Whiptail Loop W Carlsbad, CA 92010, USA
 - Country of Origin: USA
-
- Brand: CLEAR-COM
 - Product name: Digital Matrix System
 - Product Regulatory Model Number: Eclipse HX-Median
 - Country of Origin: USA

Caution: Product modification not expressly approved by the party responsible for compliance can void the user's authority to operate the equipment

14.0.1 FCC Class A

This device complies with part 15 of the FCC Rules. Operation is subject to the following two conditions: (1) This device may not cause harmful interference, and (2) this device must accept any interference received, including interference that may cause undesired operation.

Note: *This equipment has been tested and found to comply with the limits for a Class A digital device, pursuant to part 15 of the FCC Rules. These limits are designed to provide reasonable protection against harmful interference when the equipment is operated in a commercial environment. This equipment generates, uses, and can radiate radio frequency energy and, if not installed and used in accordance with the instruction manual, may cause harmful interference to radio communications. Operation of this equipment in a residential area is likely to cause harmful interference in which case the user will be required to correct the interference at his own expense.*

14.0.2 Canada ICES-003

Industry Canada ICES-003 Compliance Label: CAN ICES-3 (A)/NMB-3(A)

This Class A digital apparatus complies with Canadian ICES-003.

Cet appareil numérique de la classe A est conforme à la norme NMB-003 du Canada.

14.0.3 European Union (CE)



Directives:

EMC Directive 2014/30/EU

Low Voltage Directive 2014/35/EU

Restrictions of the use of certain hazardous substances (RoHS) Directives 2011/65/EU and (EU) 2015/863

Standards:

EN55035

EN55032

EN 62368-1

EN 61000-3-2

EN 61000-3-3

EN 63000

14.1 United Kingdom (UKCA Mark)

The UKCA (UK Conformity Assessed) marking is a new UK product marking that will be used for goods being placed on the market in Great Britain (England, Wales and Scotland). The UKCA marking alone cannot be used for goods placed on the Northern Ireland market, which require the CE marking or UK(NI) marking.



Warning:

This is a Class A product. In a domestic environment this product may cause radio interference in which case the user may be required to take adequate measures.

14.1.1 Korea KCC EMC Registration

For Class A Equipment

이 기기는 업무용(A급) 전자파 적합기기로서 판매자 또는 사용자는 이 점을 주의하시길 바라며, 가정 외의 지역에서 사용하는 것을 목적으로

Waste Electrical and Electronic Equipment (WEEE)

Customs Union EAEU



The European Union (EU) WEEE Directive (2012/19/EU) places an obligation on producers (manufacturers, distributors and/or retailers) to take-back electronic products at the end of their useful life. The WEEE Directive covers most Clear-Com products being sold into the EU as of August 13, 2005. Manufacturers, distributors and retailers are obliged to finance the costs of recovery from municipal collection points, reuse, and recycling of specified percentages per the WEEE requirements.

Instructions for Disposal of WEEE by Users in the European Union

The symbol shown below is on the product or on its packaging which indicates that this product was put on the market after August 13, 2005 and must not be disposed of with other waste. Instead, it is the user's responsibility to dispose of the user's waste equipment by handing it over to a designated collection point for the recycling of WEEE. The separate collection and recycling of waste equipment at the time of disposal will help to conserve natural resources and ensure that it is recycled in a manner that protects human health and the environment. For more information about where you can drop off your waste equipment for recycling, contact your local authority, your household waste disposal service or the seller from whom you purchased the product.

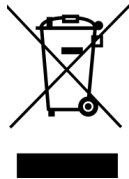

15 Specifications

Note: 0 dBu is referenced to 0.775 volts RMS.

15.1 Matrix Frame Capabilities

Category	Number / Comments
Maximum Interface Cards	7
Ports per MVX Port Card	16
Maximum MVX Port Cards	7
Maximum CPU Cards	2 (included)
Maximum E-FIB Cards	2
Maximum E-IPA, E-Que or IVC-32 or LMC-64 Cards	4 (in total)
Maximum Power Supply Units	2 (included)
Maximum RJ-45 Ports per Matrix	112
Maximum Timeslots	512

15.2 Mechanical

Category	Measures / comments
Height	10.6 inches (267 mm or 6 RU)
Width	19 inches (482 mm)
Depth	16 inches (410 mm)
Front Card Depth	300 mm
Weight	20 to 35 kg

15.3 Environmental

Category	Measures / comments
Operating Temperature	0° C to +40° C, ambient
Storage Temperature	-55° C to +70° C
Humidity, Maximum	90% non-condensing

15.4 Matrix Frame Performance

Category	Measures / Comments
Sample Rate	48 kHz
Resolution	24 bit
Frequency Response @ 48 kHz sampling	30 Hz – 22 kHz ± 3 dBu
Crosstalk (adjacent channel)	<-70 dBu
Nominal Level	0 dBu
Matrix headroom	+18 dBu
Distortion	<0.05 %, @ 0 dBu, 300 Hz to 10 kHz; <0.1 %, @ 0 dBu, 100 Hz to 20 kHz
Off Noise	<-70 dBu (20 Hz - 22kHz)
On Noise	<-65 dBu (20 Hz - 22 kHz)
Key Response, Intra-System	<40 ms for audio route

15.5 E-MADI64 Interface Front Card

Category	Measures / comments
Height	6RU
Depth	300 mm
Operating Temperature	0° C to +40° C
Storage Temperature	-55° C to +70° C
Humidity	40 - 90% non-condensing
Power	+3.3V

15.6 E-MADI64 Interface Rear Card

Category	Measures / comments
Height	6RU
Depth	58mm (max)
Operating Temperature	0° C to +40° C
Storage Temperature	-55° C to +70° C
Humidity	40 - 90% non-condensing
Power	+3.3V

15.7 E-MADI64 Fiber Cable

Category	Measures / comments
Fiber cable	Multimode 62.5/125µm
Coaxial cable	75ohm

15.8 E-MADI64 Fiber Transceiver

Category	Measures / comments
Type	Multimode SFP Transceiver
Wavelength	1310nm
Connector	Duplex LC
Standard Max Node Length	2km (other distances (achieved using the optional single mode fiber module) are available to special order.)

Note: The standard multimode fiber module is a **Class 1 LED Product**. The optional single mode fiber module is a **Class 1 Laser Product**.

15.9 E-MADI64 Clock Sources

Clock type	Clock source
Word Clock	44.1KHz
	48KHz
	96KHz
SD Video	NTSC
	PAL

Clock type	Clock source
HD Tri-Level Sync	720P60
	720P59.94
	720P50
	720P30
	720P27.97
	720P25
	720P24
	720P23.98
	1080P60
	1080P59.94
	1080P50
	1080P30
	1080P29.97
	1080P25
	1080P24
	1080P23.98
	1080I30
	1080I29.97
	1080I25
	1080I24
1080I23.98	

15.10 Fiber Interface Front Card

Category	Measures / comments
Height	6RU
Depth	300 mm
Operating Temperature	0° C to +40° C
Storage Temperature	-55° C to +70° C
Humidity	40 - 90% non-condensing
Power	+3.3V

15.11 Fiber Interface Rear Card

Category	Measures / comments
Height	6RU
Depth	58mm (max)
Operating Temperature	0° C to +40° C
Storage Temperature	-55° C to +70° C
Humidity	40 - 90% non-condensing
Power	+3.3V

15.12 Fiber Cable

Category	Measures / comments
Cable type	Single Mode 9/125μ

15.13 Fiber Transceiver

Category	Measures / comments
Type	SR1 Short Range SFP Transceiver Minimum Power Budget
Wavelength	1310nm
Connector	Duplex LC
Standard Max Node Length	10km (other distances available to special order.)

15.14 E-QUE Interface Front Card

Category	Measures / comments
Height	6RU
Depth	300 mm
Operating Temperature	0° C to +40° C
Storage Temperature	-55° C to +70° C
Humidity	40 - 90% non-condensing
Power (combined cards)	+3.3V 3.5A +5V 0.7A +12V 0.05A

15.15 E-QUE Interface Rear Card

Category	Measures / comments
Height	6RU
Depth	58 mm (max)
Operating Temperature	0° C to +40° C
Storage Temperature	-55° C to +70° C
Humidity	40 - 90% non-condensing

15.16 IVC-32 Interface Front Card

Category	Measures / comments
Height	6RU
Depth	300 mm
Operating Temperature	0° C to +40° C
Storage Temperature	-55° C to +70° C
Humidity	40 - 90% non-condensing
Power (combined cards)	+3.3V 3.5A +5V 0.7A +12V 0.05A

15.17 IVC-32 Interface Rear Card

Category	Measures / comments
Height	6RU
Depth	58 mm (max)
Operating Temperature	0° C to +40° C
Storage Temperature	-55° C to +70° C
Humidity	40 - 90% non-condensing

15.18 LMC-64 interface front card

Category	Measures / comments
Height	6RU
Depth	300 mm
Operating Temperature	0° C to +40° C
Storage Temperature	-55° C to +70° C
Humidity	40 - 90% non-condensing
Power (combined cards)	+3.3V 3.5A +5V 0.7A +12V 0.05A

15.19 LMC-64 Interface Rear Card

Category	Measures / comments
Height	6RU
Depth	58 mm (max)
Operating Temperature	0° C to +40° C
Storage Temperature	-55° C to +70° C
Humidity	40 - 90% non-condensing

15.20 E-DANTE64-HX Interface Front Card

Category	Measures / comments
Height	6RU
Depth	300 mm
Operating Temperature	0° C to +40° C
Storage Temperature	-55° C to +70° C
Humidity	40 - 90% non-condensing
Power (combined cards)	+3.3V 2.2A

15.21 E-DANTE64-HX Interface Rear Card

Category	Measures / comments
Height	6RU
Depth	300 mm
Operating Temperature	0° C to +40° C
Storage Temperature	-55° C to +70° C
Humidity	40 - 90% non-condensing
Power (combined cards)	+3.3V 2.2A

15.22 E-DANTE64-HX LAN Connectors

Category	Measures / comments
RJ45	RJ45 ports are 100/1000 MB
Fibre	To be fitted with an SFP (Small Form-factor Pluggable) Mini-GBIC (Gigabit Interface Converter), available from Clear-Com. See table below.

15.23 E-DANTE64-HX SFP Modules

Category	Measures / comments
SFP-MMFO-1G-SX	Multi-mode 1GBps SX Fiber module
SFP-SMFO-1G-LX	Single-mode 1 GBps LX Fiber module

Note: Select transceivers to match your required cable type and network infrastructure. As a general rule, the SFP-MMFO-1G-SX module can be used for shorter distances, while the SFP-SMFO-1G-LX module will provide a longer range (depending on existing cabling).

15.24 E-DANTE64-HX Sample Rates and Available Channels

Category	Measures / comments
Channels	Up to 64. Select from 16, 32 and 64
Sample rates	44.1, 48 and 96 kHz. Using 96 kHz limits the channels that can be used to 32.

15.25 E-IPA-HX Card

Category	Measures / comments
Height	6RU
Depth	300 mm
Operating Temperature	0° C to +40° C
Storage Temperature	-30° C to +70° C
Humidity	20 - 90% non-condensing
Power	+3.3V 4.75A +5V 0.77A +12V 0.18A

15.26 Analog Port Card (MVX-A16) (Cards Mark 1. & Mark 2.)

Category	Measures / comments
Height	6 RU
Depth	300 mm
Audio Interface	16, bi-directional
Input Format	Balanced
Output Format	Balanced
Ground Isolation	None; expected at User Panel/Station
Analog port card outputs	
Level	0 dBu nominal/18 dBu max.
Impedance	100 Ohms balanced
Frequency Response	30 Hz–22 kHz \pm 3 dB
Distortion	<0.05 %, @ 0 dBu, 300 Hz to 10 kHz; <0.1 %, @ 0 dBu, 100 Hz to 20 kHz
Analog port card inputs	
Level	0 dBv nominal/18 dBu max.
Impedance: card Mark 1.	600 Ohms balanced
Impedance: card Mark 2.	>10K Ohms balanced
Frequency Response	30 Hz–22 kHz \pm 3 dB
Distortion	<0.05 %, @ 0 dBu, 300 Hz to 10 kHz; <0.1 %, @ 0 dBu, 100 Hz to 20 kHz

15.27 Data Interface: 16 Bi-directional

Category	Measures / comments
Input Format	RS-422 @ 2400 to 19200 kb/s
Output Format	RS-422 @ 2400 to 19200 kb/s
Input Termination	100 ohm \pm 10%
Output Termination	None; expected at User Panel
Isolation	None; expected at User Panel

15.28 Backplane Connector: FCI/BERG Metral

Category	Measures / comments
Port Connector	RJ-45 to Clear-Com standard pinout
Transmission Distance	3000 ft. (1000 m) maximum

15.29 Power supply Unit

Category	Measures / comments
Format	Euro Cassette
Quantity	2 per matrix
Mounting	Front
Backplane Connectors	Positronics
AC Power Input	IEC (1 per PSU)
Input Voltage	AC 100 V to 240 V, 50/60 Hz
Power Consumption	300 W Maximum
Status Indicators	LEDs viewable from front of rack

Notice about specifications

While Clear-Com makes every attempt to maintain the accuracy of the information contained in its product manuals, this information is subject to change without notice.

Performance specifications included in this user guide are design-center specifications and are included for customer guidance only and to facilitate system installation.

Actual operating performance may vary.

16 Limited Warranty

Clear-Com warrants that at the time of purchase, the equipment supplied complies with any specification in the order confirmation when used under normal conditions and is free from defects in workmanship and materials during the warranty period.

During the warranty period Clear-Com, or any service company authorized by Clear-Com, will in a commercially reasonable time remedy defects in materials, design, and workmanship free of charge by repairing, or should Clear-Com in its discretion deem it necessary, replacing the product in accordance with this limited warranty. In no event will Clear-Com be responsible for incidental, consequential, or special loss or damage, however caused.

16.1 Warranty Period

The product may consist of several parts each covered by a different warranty period. The warranty periods are:

- Cables, accessories, components, and consumable items have a limited warranty of 90 days.
- Headsets, handsets, microphones, and spare parts have a limited warranty of one year.
- UHF wireless IFB products have a limited warranty of one year.
- UHF wireless intercom systems have a limited warranty of three years.
- All other Clear-Com and Drake brand systems and products, including beltpacks, have a limited warranty of two years.

The warranty starts at the time of the product's original purchase. The warranty start date for contracts which include installation and commissioning will commence from the earlier of date of the Site Acceptance Test or three months from purchase.

16.2 Technical Support

To ensure complete and timely support to its customers, Clear-Com's User Support Center is staffed by qualified technical personnel. Telephone and email technical support is offered worldwide by the User Support Center.

The User Support Center is available to Clear-Com's customers during the full course of their warranty period. Telephone support during the warranty period will be offered at no charge between 09:00 and 17:00 according to the customer's local time zone.

In addition, for customers who purchase an Extended Warranty or Service Contract, 24-hour customer support is offered immediately upon purchase of such agreement. For more information, contact your authorized dealer, distributor, or sales representative.

Instructions for reaching Clear-Com's User Support Centers are given below.

Americas and Asia-Pacific Headquarters California, United States

Tel: +1.510.337.6600

Email: CustomerServicesUS@clearcom.com

Europe, Middle East, and Africa Headquarters Cambridge, United Kingdom

Tel: +44 1223 815000

Email: SalesSupportEMEA@clearcom.com

Canada Office Quebec, Canada

Tel: +1 (450) 653-9669

China Office Beijing Representative Office Beijing, P.R.China

Tel: +8610 65811360 / 65815577

Once the standard warranty period has expired, the User Support Center will continue to provide telephone support if you have purchased an Extended Warranty or Service Contract. In these cases, you will have access to telephone support 24 hours per day, 7 days per week.

16.3 Warranty Repairs and Returns

Before returning equipment for repair, contact a User Support Center to obtain a Return Material Authorization (RMA). Clear-Com representatives will give you instructions and addresses for returning your equipment. You must ship the equipment at your expense, and the support center will return the equipment at Clear-Com's expense.

For out-of-box failures, use the following contact information:

Americas and Asia-Pacific Headquarters California, United States

Tel: +1.510.337.6600

Email: CustomerServicesUS@clearcom.com

Europe, Middle East, and Africa Headquarters Cambridge, United Kingdom

Tel: +44 1223 815000

Email: SalesSupportEMEA@clearcom.com

Canada Office Quebec, Canada

Tel: +1 (450) 653-9669

China Office Beijing Representative Office Beijing, P.R.China

Tel: +8610 65811360 / 65815577

Clear-Com has the right to inspect the equipment and/or installation or relevant packaging.

16.4 Non-Warranty Repairs and Returns

For items not under warranty, you must obtain an RMA by contacting the User Support Center. Clear-Com representatives will give you instructions and addresses for returning your equipment.

You must pay all charges to have the equipment shipped to the support center and returned to you, in addition to the costs of the repair.

16.5 Extended Warranty

If you purchase an Extended Warranty, you are also given access free of charge to the User Support Center 24 hours a day, 7 days a week.

You can purchase an extended warranty at any time during the first two years of ownership of the product. The purchase of an extended warranty extends to five years the warranty of any product offered with a standard two-year warranty. The total warranty period will not extend beyond five years. Any purchase of an extended warranty provides 24 x 7 customer support in addition to the warranty immediately upon purchase of the warranty extension.

Note *Clear-Com does not offer warranty extensions on UHF wireless intercom systems, or on any product with a 1-year or 90-day warranty.*

16.6 Service Contract

Clear-Com also offers service contracts that provide 24 x 7 telephone support, advance replacements, training, proactive maintenance, on-site visits, and no charge for repair or replacement of equipment. For more information, contact your authorized dealer, distributor, or sales representative.

16.7 Liability

THE FOREGOING WARRANTY IS CLEAR-COM'S SOLE AND EXCLUSIVE WARRANTY. THE IMPLIED WARRANTY OF MERCHANTABILITY AND FITNESS FOR A PARTICULAR PURPOSE AND ANY OTHER REQUIRED IMPLIED WARRANTY SHALL EXPIRE AT THE END OF THE WARRANTY PERIOD. THERE ARE NO OTHER WARRANTIES (INCLUDING WITHOUT LIMITATION WARRANTIES FOR CONSUMABLES AND OTHER SUPPLIES) OF ANY NATURE WHATSOEVER, WHETHER ARISING IN CONTRACT, TORT, NEGLIGENCE OF ANY DEGREE, STRICT LIABILITY OR OTHERWISE, WITH RESPECT TO THE PRODUCTS OR ANY PART THEREOF DELIVERED HEREUNDER, OR FOR ANY DAMAGES AND/OR LOSSES (INCLUDING LOSS OF USE, REVENUE, AND/OR PROFITS). SOME STATES DO NOT ALLOW THE EXCLUSION OR LIMITATION OF INCIDENTAL OR CONSEQUENTIAL DAMAGES OR THE LIMITATION ON HOW LONG AN IMPLIED WARRANTY LASTS, SO THE ABOVE LIMITATIONS MAY NOT APPLY TO YOU. IN ANY EVENT, TO THE MAXIMUM EXTENT PERMITTED UNDER APPLICABLE LAW, CLEAR-COM'S LIABILITY TO CUSTOMER HEREUNDER SHALL NOT UNDER ANY CIRCUMSTANCES EXCEED THE COST OF REPAIRING OR REPLACING ANY PART(S) FOUND TO BE DEFECTIVE WITHIN THE WARRANTY PERIOD AS AFORESAID.

This warranty does not cover any damage to a product resulting from cause other than part defect and malfunction. The Clear-Com warranty does not cover any defect, malfunction, or failure caused beyond the control of Clear-Com, including unreasonable or negligent operation, abuse, accident, failure to follow instructions in the manual, defective or improperly associated equipment, attempts at modification and repair not approved by Clear-Com, and shipping damage. Products with their serial numbers removed or defaced are not covered by this warranty.

This warranty does not include defects arising from installation (when not performed by Clear-Com), lightning, power outages and fluctuations, air conditioning failure, improper integration with non-approved components, defects or failures of customer furnished components resulting in damage to Clear-Com provided product.

This limited warranty is not transferable and cannot be enforced by anyone other than the original consumer purchaser.

This warranty gives you specific legal rights and you may have other rights which vary from country to country.