

User Guide

V-Series IrisX Panel User Guide



Part Number: PUB-00277 Revision A

Date: October 29, 2024

Document Reference

V-Series IrisX Panels User Guide

Part Number: PUB-00277 Revision A

Legal Disclaimers

Copyright © 2024 HME Clear-Com Ltd.

All rights reserved.

Clear-Com and the Clear-Com logo are trademarks or registered trademarks of HM Electronics, Inc.

The software described in this document is furnished under a license agreement and may be used only in accordance with the terms of the agreement.

The product described in this document is distributed under licenses restricting its use, copying, distribution, and decompilation/reverse engineering. No part of this document may be reproduced in any form by any means without prior written authorization of Clear-Com, an HME Company.

Clear-Com Offices are located in California, USA; Cambridge, UK; Dubai, UAE; Montreal, Canada; and Beijing, China. Specific addresses and contact information can be found on Clear-Com's corporate website:

www.clearcom.com

Clear-Com Contacts

Americas and Asia-Pacific Headquarters

California, United States

Tel: +1 510 337 6600

Email: CustomerServicesUS@clearcom.com

Europe, Middle East, and Africa Headquarters

Cambridge, United Kingdom

Tel: +44 1223 815000

Email: CustomerServicesEMEA@clearcom.com

China Office

Beijing Representative Office

Beijing, P.R.China

Tel: +8610 65811360/65815577

Email: SalessupportChina@clearcom.com

Table of contents

1 Important Safety Instructions	7
Safety symbols	8
2 Introduction	9
2.1 IrisX panels covered by this guide	9
2.2 Supported fonts in IrisX panels	10
3 Interconnectivity overview	12
4 Front panel lights and controls	13
4.1 Keysets	13
4.2 IrisX lever panel (32 key)	14
4.3 IrisX lever (12 key)	15
4.4 IrisX lever panel (expansion)	16
4.5 IrisX pushbutton panel (12 key)	16
4.6 IrisX pushbutton panel (expansion)	17
4.7 IrisX rotary panel (24 key)	17
4.8 IrisX rotary panel (12 key)	18
4.9 IrisX rotary panel (expansion)	19
5 Installing IrisX panels	20
5.1 Placing panels	20
5.2 Connecting IrisX panels	20
5.3 IP connection to matrix	32
5.4 Redundant Network Connections	39
5.5 Front panel connectors	46
5.6 Placing expansion panels	52
5.7 Panel parameters in EHX	53
6 Using the Front Panel Controls	57
6.1 Key display window	57
6.2 Mic On	61
6.3 Shift Page	61
6.4 Headset Select	63

6.5 Menu	63
6.6 LS Main levels (volume) control	64
6.7 Auxiliary levels (volume) control	64
6.8 Listen Again	64
6.9 Up / Down buttons on lever key and pushbutton panels	65
6.10 Alternative text key	65
6.11 Rotary control on rotary panels	66
6.12 Dial pad (2RU panels)	66
6.13 Push-To-Talk (PTT) operation	67
6.14 Status LEDs (Tallies)	68
6.15 Communication errors	68
6.16 Lever key panels	68
VI-PNLB-32L function key options	70
6.17 Pushbutton panels	73
6.18 Rotary panels	74
7 Connecting the IrisX panel to a matrix	79
7.1 AoIP interconnectivity	79
7.2 IVC connectivity	83
7.3 Setting a static IP address	84
7.4 Device discovery	85
7.5 Network requirements	87
8 Role Based Sessions Introduction	89
8.1 Example workflows	89
8.2 Using Role based Intercom Sessions	91
8.3 Security and priority, role based sessions	92
9 Front panel color displays, IrisX panel	94
9.1 Default TFT colors	94
10 Using the Menu System	98
10.1 Navigating the menu system	98
10.2 Fast Key Assign	99
10.3 Scrolling assignment	103
10.4 Top level menu	103

10.5 SYS INFO (System Information) menu	105
10.6 LOCAL PREF (Local Preferences) menu	117
10.7 SYS CONFIG (System Configuration) menu	126
10.8 DIAGNOSTIC menu	146
10.9 CALL menu	152
10.10 DIAL menu	154
10.11 LOCAL EXCL (Local Exclusive) menu	156
10.12 LOCAL PAGE (Local Page override) menu	157
10.13 ASSNMT PNL (Assignment Panel) menu	158
10.14 SUPERVISE menu	164
10.15 SHIFT menu	168
10.16 Menu map	170
10.17 Accessing the IP configuration menus	171
10.18 IP SETUP menu	171
10.19 NET SETUP menu	180
10.20 CONFIRM CLEAR menu	191
10.21 IP menu map	192
11 Maintaining V-Series Panels	193
11.1 Accessing the Local Maintenance Menu (LMM)	193
11.2 Navigating the LLM menu	194
11.3 Use of displays	195
11.4 Commands	196
12 Upgrading the IrisX panel	209
12.1 Upgrade the panel using the EHX software	209
12.2 Upgrade the panel by USB	209
13 Compliance	211
13.1 V-Series IrisX Panels – User Guide Compliance Section	211
13.2 USA FCC EMC Class A	211
13.3 Canada ICES-003 EMC Class A	212
13.4 European Union (CE)	212
13.5 United Kingdom (UKCA Mark)	212

13.6 Directives	213
13.7 Standards:	213
13.8 Korea KCC EMC Registration	213
14 Specifications	214
14.1 Front panel controls and connectors	214
14.2 Main panel rear connectors	214
14.3 Expansion panel rear connectors	214
14.4 Panel microphone input	215
14.5 Headset microphone input	215
14.6 Auxiliary loudspeaker output	215
14.7 Audio input/output (MVX-Analogue)	215
14.8 AC mains power supply (external)	216
14.9 Temperature	216
14.10 Humidity	216
14.11 Dimensions (1RU panels)	216
14.12 Dimensions (2RU panels)	217
14.13 Dimensions (Expansion panels)	218
15 Appendix: IrisX panel dip switches and D25 pinouts	219
15.1 SW4 = Headset autodetect.	219
15.2 DB25 Male analog expansion connector(J9 on rear panel)	219
15.3 DB25 Female expansion GPIO (J11 on rear panel)	220
16 Glossary	221

1 Important Safety Instructions

1. Read these instructions.
2. Keep these instructions.
3. Heed all warnings.
4. Follow all instructions.
5. Do not use this apparatus near water.
6. Clean only with dry cloth.
7. Do not block any ventilation openings. Install in accordance with the manufacturer's instructions.
8. Do not install near any heat sources such as radiators, heat registers, stoves, or other apparatus (including amplifiers) that produce heat.
9. Do not defeat the safety purpose of the polarized or grounding-type plug. A polarized plug has two blades and a third grounding prong. The wide blade or the third prong are provided for your safety. If the provided plug does not fit into your outlet, consult an electrician for replacement of the obsolete outlet.
10. Protect the power cord from being walked on or pinched particularly at plugs, convenience receptacles, and the point where they exit from the apparatus.
11. Only use attachments/accessories specified by the manufacturer.
12. Use only with the cart, stand, tripod, bracket, or table specified by the manufacturer, or sold with the apparatus. When a cart is used, use caution when moving the cart/apparatus combination to avoid injury from tip-over.
13. Unplug this apparatus during lightning storms or when unused for long periods of time.
14. Refer all servicing to qualified service personnel. Servicing is required when the apparatus has been damaged in any way, such as power-cord supply or plug is damaged, liquid has been spilled or objects have fallen into the apparatus, the apparatus has been exposed to rain or moisture, does not operate normally, or has been dropped.
15. Warning: To reduce the risk of fire or electric shock, do not expose this product to rain or moisture.

Safety symbols

Familiarize yourself with the safety symbols below. These symbols are displayed on the apparatus and warn you of the potential danger of electric shock if the system is used improperly. They also refer you to important operating and maintenance instructions in the product user manual.

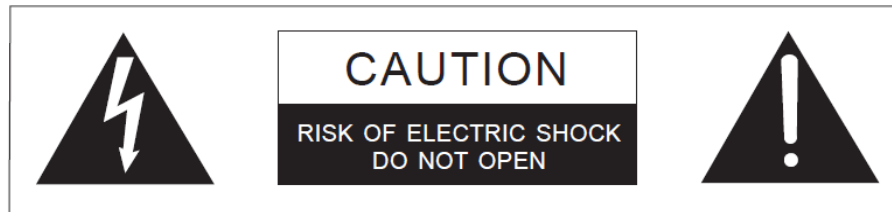

This symbol alerts you to the presence of uninsulated dangerous voltage within the product's enclosure that might be of sufficient magnitude to constitute a risk of electric shock. Do not open the product's case.



This symbol informs you that important operating and maintenance instructions are included in the literature accompanying this product.

Safety symbols

1.0.1 Mains power cord

V-Series IrisX panels are supplied with a 60 watt sleeve-locking power connector.

Note: *When connecting the sleeve-locking power cable, be sure to push until the connector locks into the device.*

2 Introduction

This User Guide describes how to install, use and maintain V-Series™ IrisX panels from HME Clear-Com®

IrisX panels include a wide range of advanced features for ease of use and superior audio performance:

- Enhanced keyset displays.
- Keys with 10-character color TFT displays allow you to easily and quickly monitor the panel (EHX 11.0 and above).
- AES67 audio over IP (AoIP) for low-latency, high-quality audio (EHX 11.0 and above).
- Up to three channels of audio: intercom channel with the option to route up to two extra audio channels.
- Firmware upgrade by front panel USB connection.

IrisX panels are available in 1 and 2 RU (Rack Unit) and are available in:

- Lever key format with 32 or 12 keys.
- Pushbutton format with 12 or 24 keys.
- Rotary format with 12 or 24 keys.

Each IrisX panel can connect up to eight expansion panels.

V-Series IrisX panels and expansion panels are not compatible with older V-Series and V-Series Iris panels and expansion panels.

The expansion panel will not work in either case.

2.1 IrisX panels covered by this guide

The IrisX family of panels comprises the following product numbers:

Format	Product number	Description
Lever	VI-PNLB-32L-XX	19" rack mount 1RU 32 lever key panel with enhanced displays.
	VI-PNLB-12L-XX	19" rack mount 1RU 12 lever key panel with enhanced displays.
	VI-EXPB-16L	19" rack mount 1 RU 16 lever key expansion panel with enhanced displays.

Format	Product number	Description
Pushbutton	VI-PNLB-24P-XX	19" rack mount 1RU 24 pushbutton panel.
	VI-PNLB-12P-XX	19" rack mount 2RU 12 pushbutton panel.
	VI-EXPB-12P	19" rack mount 1RU 12 pushbutton expansion panel.
Rotary	VI-PNLB-24R-XX	19" rack mount 1RU 24 rotary control panel.
	VI-PNLB-12R-XX	19" rack mount 2RU 12 rotary control panel.
	VI-EXPB-12R	19" rack mount 1RU 12 rotary control expansion panel.

2.2 Supported fonts in IrisX panels

Font	Description / comments
Basic Latin	<p>The backslash is a Yen character. This is a size-maximized font (no descenders, lower-case characters are not relative in size to upper-case characters).</p> <p>This covers Unicode 32 to 127 (decimal), 0x20 to 0x7F (hex). The V-Series panel display will support ten characters.</p>
Cyrillic	<p>This is a normal, relatively-sized font. Covers Unicode 1024 to 1279 (decimal), 0x400 to 0x4FF (hex) with some missing characters.</p> <p>The V-Series panel display will support ten characters.</p>
Hiragana	<p>This covers the codepoint range 12352 to 12447 (decimal), 0x3040 to 0x309F (hex).</p> <p>The V-Series panel display will support five characters.</p>
Full-width Katakana	<p>The V-Series panel display will support five characters, as this is a normal width font.</p> <p>This covers the codepoint range 12448 to 12543 (decimal), 0x30A0 to 0x30FF (hex) with some missing characters.</p>
Kanji	<p>Displays 17,000 out of the 21,000 characters. This covers the codepoint range 19968 to 40895 (decimal), 0x4E00 to 0x9FBF (hex).</p> <p>The V-Series panel display will support five characters.</p>

Font	Description / comments
Hangul	The range is 44032 to 55215 (decimal), 0xAC00 to 0xD7AF (hex). The V-Series panel display will support five characters.
Half-width Katakana	The codepoint range is 65376 to 65440 (decimal), 0xFF60 to 0xFFA0 (hex). The V-Series IrisX panel display will support ten characters.
Arabic	The character range supported on the V-Series IrisX panel is the Basic Arabic character set 0x0600 to 0x06FF.

Supported fonts

3 Interconnectivity overview

There are three different connection methods for the IrisX Panel. AoIP and IVC are both connections over IP.

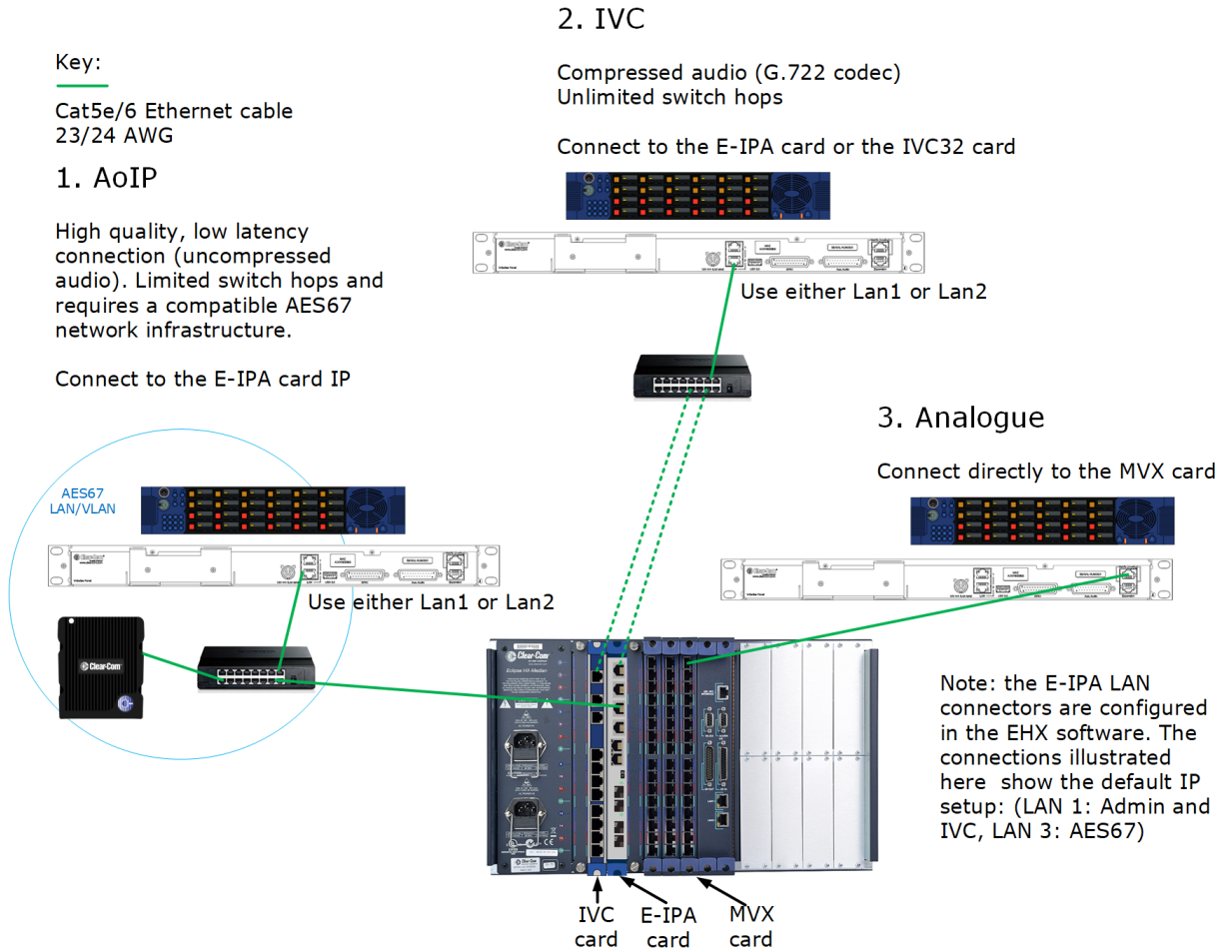

Interconnectivity overview for IrisX panel connections

IrisX panels have dual MAC addresses . If connected to a switch with security enabled to allow only one MAC address then this will stop the IrisX panel working correctly. Disable security settings or modify the operation to allow for 2 MAC addresses on the switch port.

4 Front panel lights and controls

The IrisX front panels contain controls, displays and LEDs that enable you to control and monitor the panel.

4.1 Keysets

Each V-Series IrisX panel has 12, 24 or 32 keysets. The keysets enable you to control and view the status of audio associated with the keyset.

For example, you can activate audio, adjust audio volume levels and view the color TFTs to easily identify what kind of audio is present.

An example of a keyset (for a pushbutton panel) is shown below.

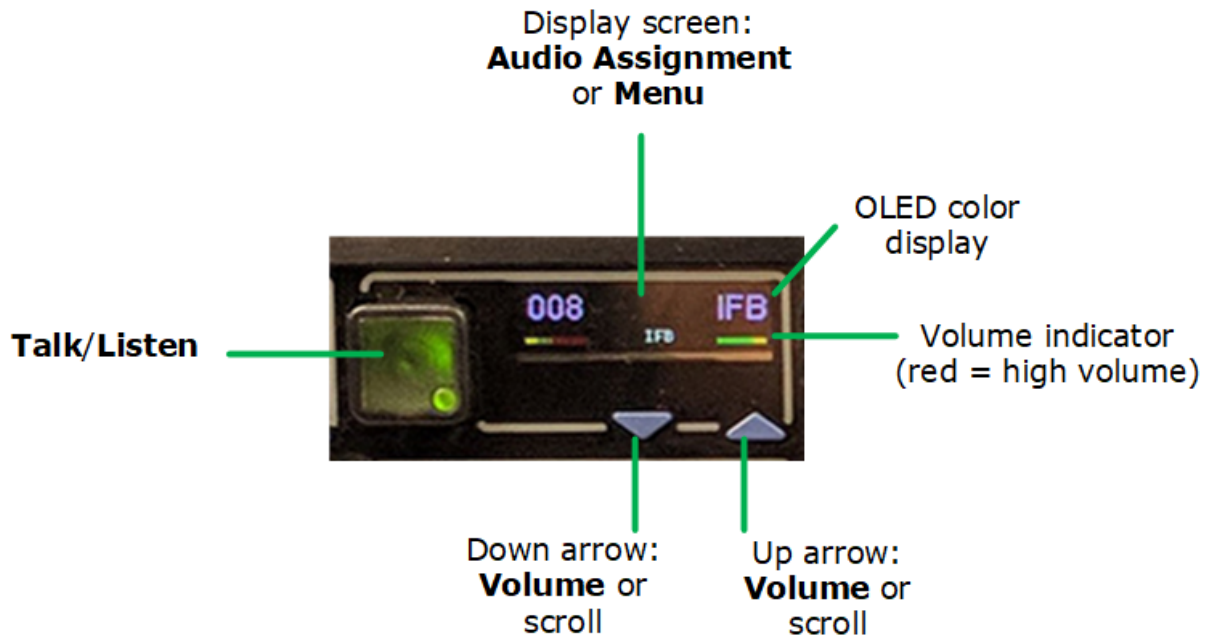

Keysets overview

4.2 IrisX lever panel (32 key)

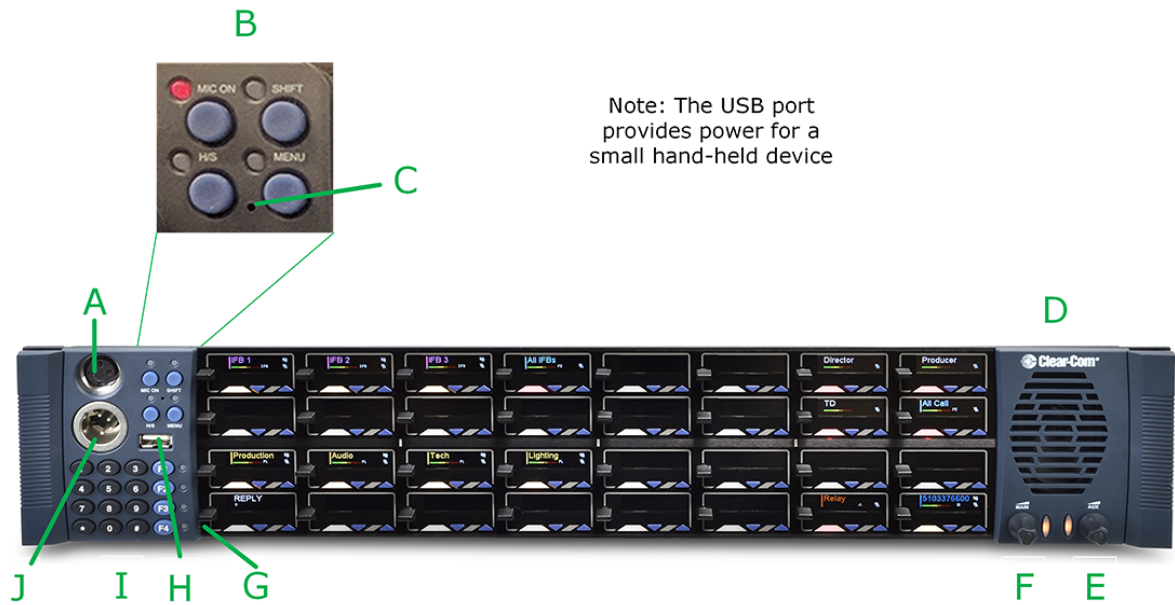

32-key IrisX lever panel

Item	Description
A	Microphone socket
B	Microphone ON push button with LED indicator Shift Page SELECT button with LED indicator Headset SELECT button with LED indicator MENU SELECT push button with LED indicator
C	Pin reset
D	Loudspeaker
E	Auxiliary volume control indicator LED. Rotate for volume control. Quick push of volume control for Listen Again function. Push and hold to display listen labels in the keyset display screens.
F	Main volume control with indicator LED. Rotate for volume control. Push volume control to cut loudspeaker.
G	Reply key
H	USB connector
I	Dial keypad
J	Headset socket

32-key IrisX lever panel controls and connectors

4.3 IrisX lever (12 key)

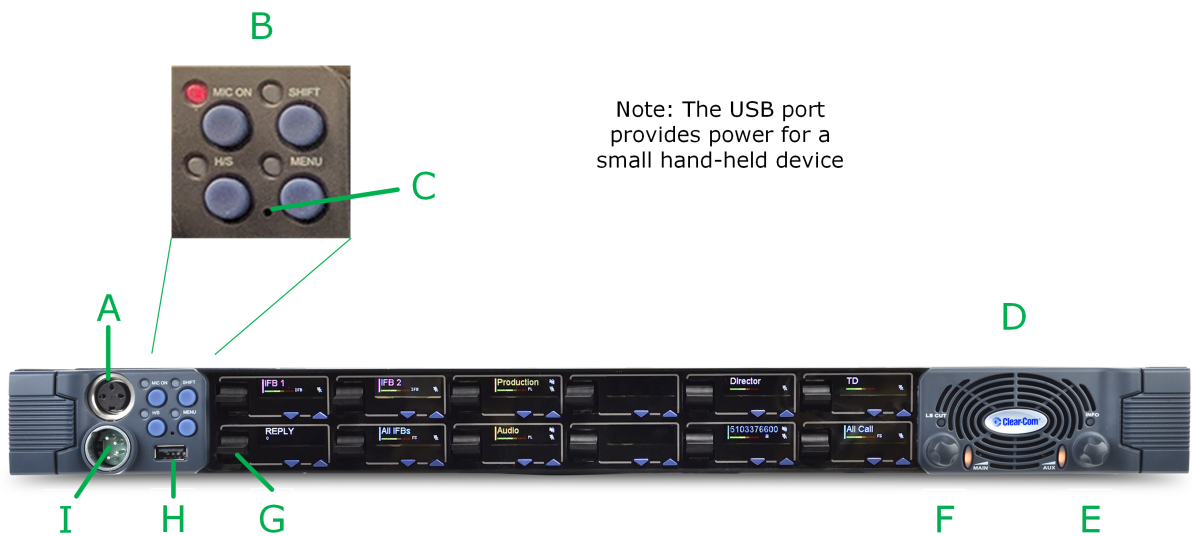

Note: The USB port provides power for a small hand-held device

12-key IrisX lever panel

Item	Description
A	Microphone socket
B	Microphone ON push button with LED indicator Shift Page SELECT button with LED indicator Headset SELECT button with LED indicator MENU SELECT push button with LED indicator
C	Pin reset
D	Loudspeaker
E	Auxiliary volume control indicator LED. Rotate for volume control. Quick push of volume control for Listen Again function. Push and hold to display listen labels in the keyset display screens.
F	Main volume control with indicator LED. Rotate for volume control. Push volume control to cut loudspeaker.
G	Reply key
H	USB connector
I	Headset socket

12-key IrisX lever panel controls and connectors

4.4 IrisX lever panel (expansion)



IrisX expansion lever panel

4.5 IrisX pushbutton panel (12 key)



12-key IrisX pushbutton panel

Item	Description
A	Microphone socket
B	Microphone ON push button with LED indicator Shift Page SELECT button with LED indicator Headset SELECT button with LED indicator MENU SELECT push button with LED indicator
C	Pin reset
D	Loudspeaker
E	Auxiliary volume control indicator LED. Rotate for volume control. Quick push of volume control for Listen Again function. Push and hold to display listen labels in the keyset display screens.
F	Main volume control with indicator LED. Rotate for volume control. Push volume control to cut loudspeaker.
G	Reply key
H	USB connector
I	Headset connector

12-key IrisX pushbutton panel

4.6 IrisX pushbutton panel (expansion)



IrisX expansion pushbutton panel

4.7 IrisX rotary panel (24 key)

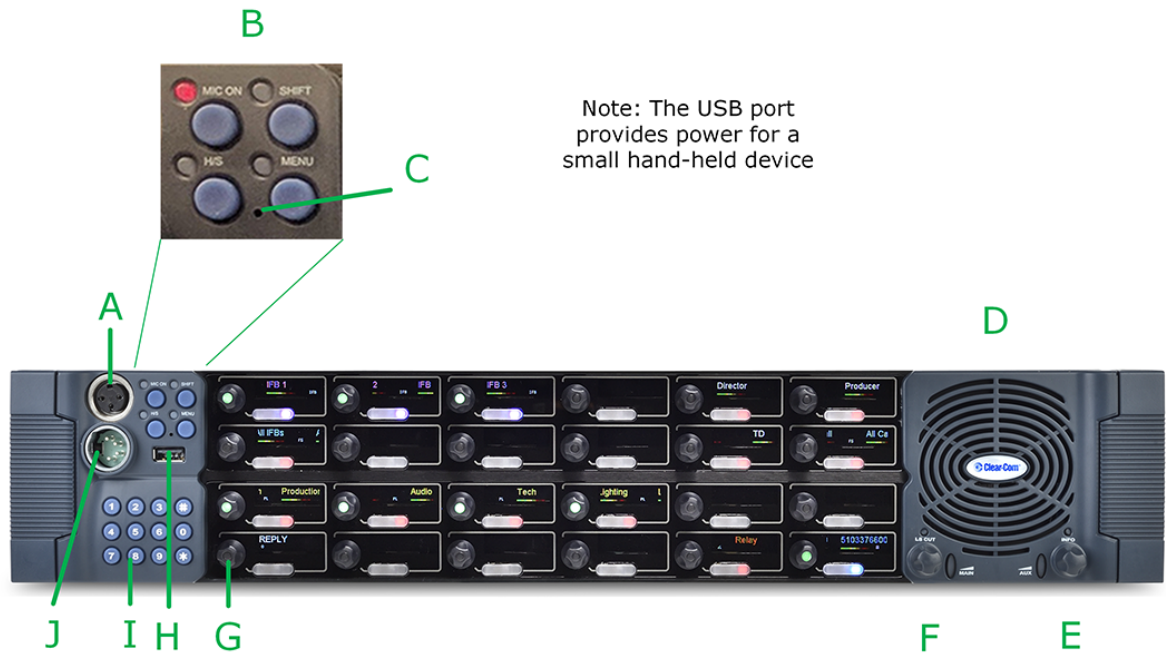

24-key IrisX rotary panel

Item	Description
A	Microphone socket
B	Microphone ON push button with LED indicator Shift Page SELECT button with LED indicator Headset SELECT button with LED indicator MENU SELECT push button with LED indicator
C	Pin reset
D	Loudspeaker

Item	Description
E	Auxiliary volume control indicator LED. Rotate for volume control. Quick push of volume control for Listen Again function. Push and hold to display listen labels in the keyset display screens.
F	Main volume control with indicator LED. Rotate for volume control. Push volume control to cut loudspeaker.
G	Reply key
H	USB connector
I	Dial keypad
J	Headset socket

24-key IrisX rotary panel controls and connectors

4.8 IrisX rotary panel (12 key)

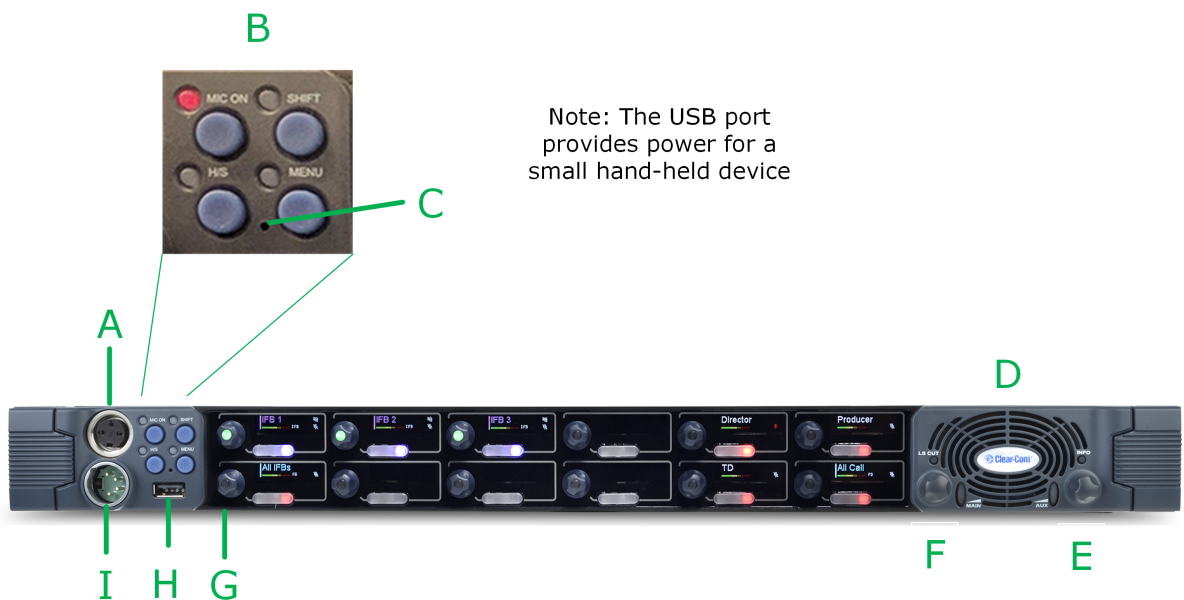

12-key IrisX rotary panel

Item	Description
A	Microphone socket
B	Microphone ON push button with LED indicator Shift Page SELECT button with LED indicator Headset SELECT button with LED indicator MENU SELECT push button with LED indicator
C	Pin reset
D	Loudspeaker
E	Auxiliary volume control indicator LED. Rotate for volume control. Quick push of volume control for Listen Again function. Push and hold to display listen labels in the keyset display screens.
F	Main volume control with indicator LED. Rotate for volume control. Push volume control to cut loudspeaker.
G	Reply key
H	USB connector
I	Headset socket

12-key IrisX rotary panel controls and connectors

4.9 IrisX rotary panel (expansion)



IrisX expansion rotary panel

5 Installing IrisX panels

This chapter describes how to install V-Series panels, including expansion panels. It also describes how to install the optional two additional IP channels that are available.

5.1 Placing panels

When placing panels, take the following points into account:

- Locate all panels at comfortable heights for operation and leave at least 2 inches (51 mm) of clearance behind the rear of the panel's chassis to allow for cable connectors.
- Expansion panels are usually installed next to or near the main panel. Leave at least 2 inches (51 mm) of clearance behind the rear of each expansion panel to allow for cable connectors.
- Connect expansion panels using straight through 8-way shielded CAT5 cable with RJ45 connectors.

Expansion panels can be connected to the main panel in a daisy chain using cables not more than 16 ft (5 m) long between each panel. The cable length of any daisy chain of panels must not exceed 24 ft (7.5 m) in total.

5.2 Connecting IrisX panels

The IrisX panel has three different connection modes. It can be connected to;

- A Clear-Com MVX interface card (a 4-wire/analog connection)
- A Clear-Com IVC-32 interface card or E-IPA interface card (an IP connection using Clear-Com proprietary technology and the G7.22 codec)
- A Clear-Com E-IPA interface card (an IP connection using AES67 low latency streaming audio)

5.2.1 Wiring IrisX panels

Eclipse / Eclipse HX uses shielded CAT5 cable between the panel and the matrix, and between panels and expansion panels using the industry standard RJ-45 connector.

To connect to external devices, use the GPIO connector with the DB-25F connector, and the auxiliary audio connector with the DB-25M connector.

When using an AES67 connection between a Clear-Com AoIP device (the IP transceiver or the IrisX panel) and a matrix, you must use CAT6e cable at 23/24 AWG in order to achieve the Ethernet standard connection length of up to 100m .

The following sections describe:

- Connecting the panel to the matrix.-
- Connections between panels and local devices.
- Connections between panels and expansion panels.

In the V-Series rear panel diagrams in this section, the Matrix Connector (RJ-45) corresponds to the EXT0 connection that is used when panels have additional IP channels. See [IP connection to matrix on page 32](#).

For detailed wiring information concerning Eclipse HX connections, see the Eclipse HX Installation Guide.

5.2.2 IrisX panel rear connectors

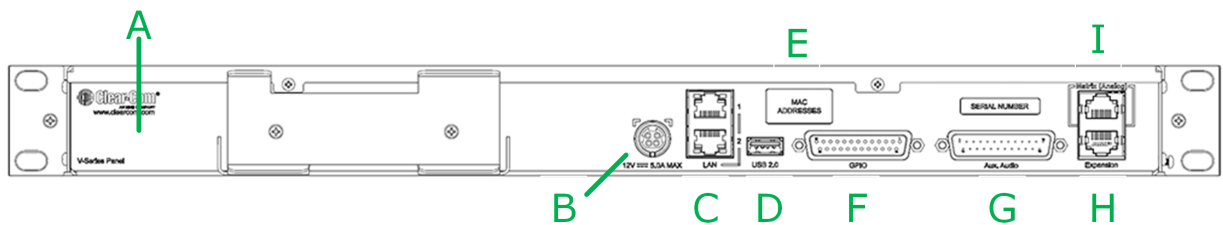

IrisX rear panel connectors

Item	Description of connector
A	Grounding screw
B	Sleeve locking power connector (12V, 60W). When connecting the sleeve-locking power connector, be sure to push until the sleeve locks into the device.
C	LAN 1 and LAN 2 (RJ45). Use either connector (not both) and do not connect more than one IP port to your network at the same time. This may lead to a broadcast storm and could seriously degrade the performance of your network. *
D	Micro USB connector, used for upgrades.
E	mDNS and MAC address labels (2). It is helpful to make a note of the mDNS number as this can be used to reach the device IP address if for any reason you cannot reach the panel on your network.
F	GPIO connector (DB25F)

Item	Description of connector
G	Auxiliary audio connector (DB25M)
H	Expansion panel connector (RJ45)
I	Analog matrix connector (RJ45)

For more information on how the rear LAN connectors work see [IrisX panel rear LAN connectors on page 28](#)

Note: * From EHX v.13.0 and V-Series IrisX v. 6.51 upwards, V-Series IrisX LAN ports conduct link status monitoring. Due to this, daisy-chaining of panels is NOT supported from these versions. See [Link Status Monitoring in this manual](#).

5.2.3 IrisX expansion rear connectors

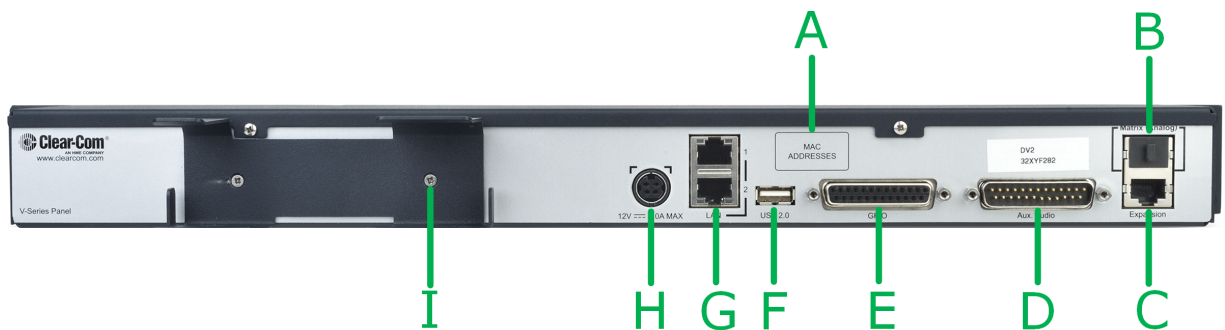

Item	Description of connector
A	mDNS and MAC address labels (2). It is helpful to make a note of the mDNS number as this can be used to reach the device IP address if for any reason you cannot reach the panel on your network.
B	Analog matrix connector (RJ45)
C	Expansion panel connector (RJ45)
D	Auxiliary audio connector (DB25M)
E	GPIO connector (DB25F)
F	Micro USB connector, used for upgrades.

Item	Description of connector
G	LAN 1 and LAN 2 (RJ45). Use either connector (not both) and do not connect more than one IP port to your network at the same time. This may lead to a broadcast storm and could seriously degrade the performance of your network.
H	Sleeve locking power connector (12V, 60W). When connecting the sleeve-locking power connector, be sure to push until the sleeve locks into the device.
I	Grounding screw

5.2.4 Power connector wiring

The power supply is a 4 pin socket which is connected to an external 12V power supply. The pinout for the connector is shown below.

IrisX power connector

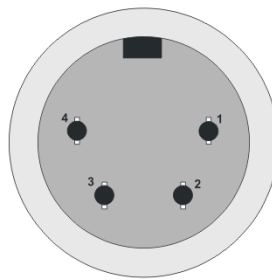

IrisX power connector pinout

Pin	Description
1	Not connected
2	12VDC
3	Not connected
4	0V

5.2.5 Panel-to-matrix card baud rate

The RS-422 serial data communication between a panel and other devices operates at 19.2 k baud by default.

5.2.6 Analog matrix to panel wiring

The analogue audio and RS-422 data communication between the IrisX panel and the matrix uses a 4-pair wiring scheme between the matrix and panels. The panels connect to a port on the matrix MVX-A16 card.

Four-pair analog wiring is wired with shielded CAT5 RJ-45 cable:

- Pair 1 transmits analog audio from the matrix port to the panel.
- Pair 2 transmits RS-422 data from the panel back to the matrix card port.
- Pair 3 transmits analog audio from the panel to the matrix card port.
- Pair 4 transmits RS-422 data from the matrix port back to the panel.

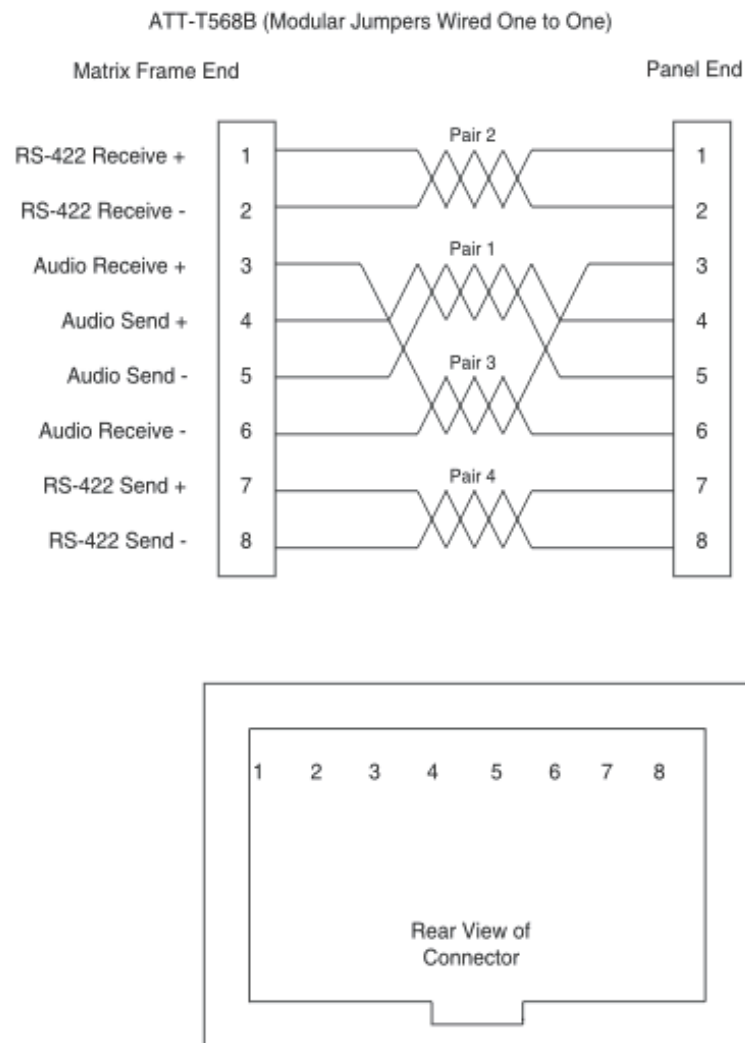

Analog matrix to panel wiring diagram

5.2.7 Matrix panel GPIO connector wiring

The Panel GPIO connectors have two programmable relay outputs (GPOs) to connect to third-party devices, and four opto-inputs to connect to third-party devices.

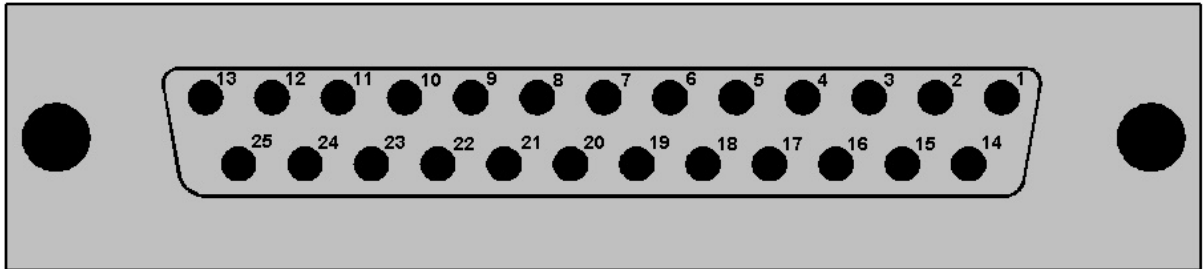

Matrix to panel GPIO connector

Pin	Description	Pin	Description
1	Panel Mute relay output Normally Closed	14	Panel Mute output relay Common
2	Panel Mute relay output Normally Open	15	Panel Aux output relay Normally Closed
3	Panel Aux output relay Common	16	Panel Aux output relay Normally Open
4	Not connected	17	Not connected
5	Not connected	18	Not connected
6	Not connected	19	Not connected
7	Not connected	20	5V
8	0V	21	5V
9	0V	22	Opto-isolated input A1
10	Opto-isolated input B1	23	Opto-isolated input A2
11	Opto-isolated input B2	24	Opto-isolated input A3
12	Opto-isolated input B3	25	Opto-isolated input A4
13	Opto-isolated input B4	-	-

Matrix to panel GPIIP connector pinouts

Note: *The Relay 1 and 2 outputs on the GPIO connector are referred to in EHX Controls as Panel mute relays and Panel AUX relays respectively.*

5.2.8 Programmable Relay contacts

Each panel includes two relays which are:

- Controlled by the matrix.
- Independent of the local panel function.

These relays can be assigned to any label(s) in the system, which will activate whenever a talk or listen is set to that label(s).

If you simply wish to trigger a relay, assign the relay to a control label. For more information, see your EHX documentation.

The relay can activate an external device, such as an applause light in a studio, a cue light, or a security door lock. Any programmable relay in the system can be activated from any panel in the system, including a direct-inward-access caller.

[Matrix panel GPIO connector wiring on page 25](#) shows the wiring of the relay contacts to the GPIO connector.

Both normally open and normally closed contacts are provided. They are rated at 1 Amp at 24 V DC. This relay is not designed for switching mains AC line voltage. To switch an external device running on mains AC line voltage, use an external relay (or other switching mechanism) activated by this relay.

5.2.9 Opto-isolated inputs

Each main panel provides four opto-isolated inputs using the GPIO interface.

Each input consists of a pair of pins on the GPIO with an operating range of 4V to 30V DC or AC. These inputs can be used for user programmable functions set up by EHX to execute other actions within the system such as switching a microphone on or off.

Inputs 1 and 2 (pins A1/B1 and A2/B2) are available for assignment in EHX in **Advanced Settings > Logic Inputs**, while input 3 (pins A3/B3) is preassigned in EHX to trigger the Reply Key function.

Input 4 (pins A4/B4) is not currently used.

The inputs are operated by applying a voltage between 4V and 30V DC or AC across the pins so that a current flows through the circuit and is detected by the opto-coupler.

The voltage may be derived from the panel itself using the 5V and 0V pins on the GPIO or it may be from an external source. An example is a circuit using a footswitch to activate the panel microphone using logic input 1.

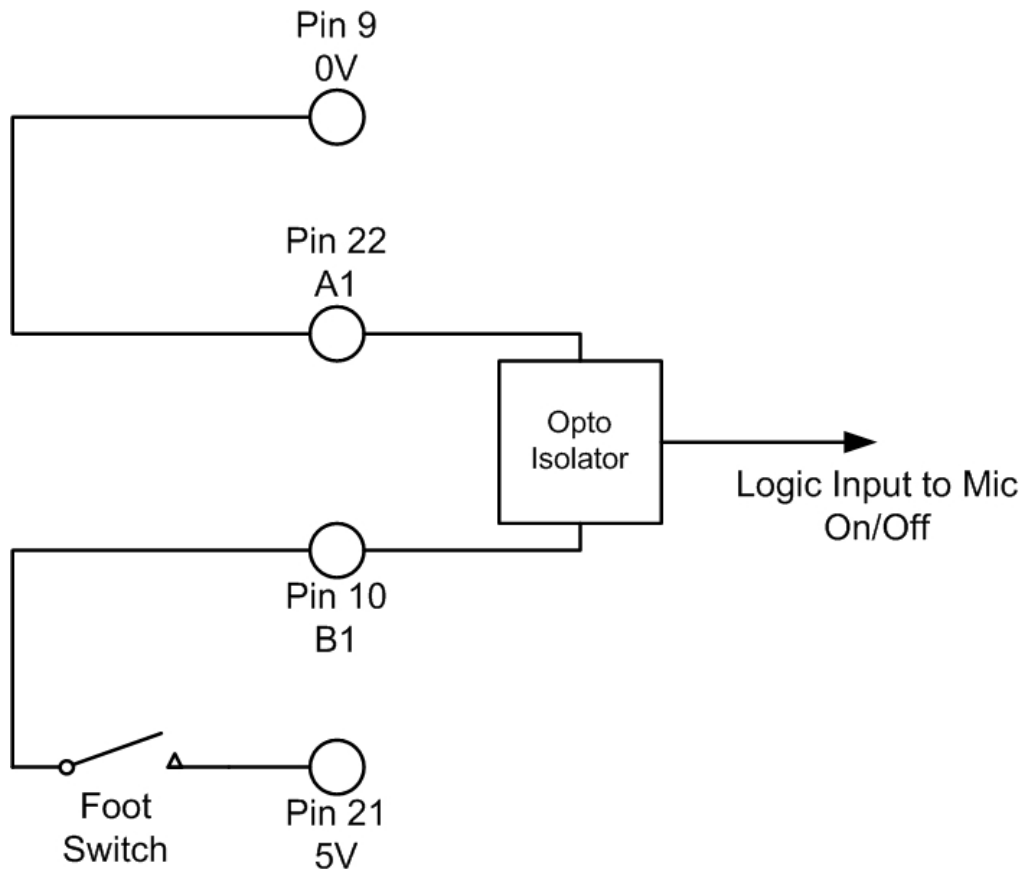

Opto-isolated inputs

In the above example, pressing the footswitch applies 5V DC from the panel between B1 and A1. This enables the detection of a logic input.

If logic input 1 has been configured in EHX to activate the Mic On/Off function the footswitch could be used to control the panel microphone.

5.2.10 Auxiliary audio connector

The auxiliary audio connector allows additional audio inputs and outputs to be connected to the panel.

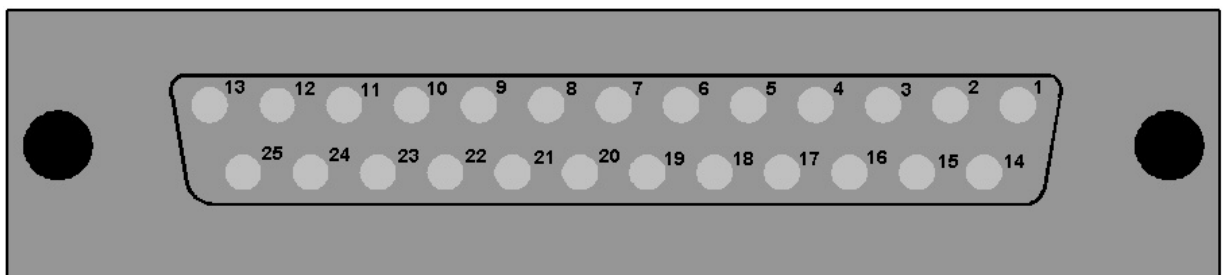

Auxiliary audio connector

Pin	Description	Pin	Description
1	Headset 2 MIC +ve	14	Headset 2 MIC -ve
2	Headset 2 Left Ear	15	Headset 2 Left Ear Ground
3	Headset 2 Right Ear	16	Headset 2 Right Ear Ground
4	Headset 2 PTT 1	17	Headset 2 PTT 2
5	0V	18	0V
6	0V	19	0V
7	External Output 2 +ve	20	External Output 2 -ve
8	External Output 1 +ve	21	External Output 1 -ve
9	Hot MIC Output +ve	22	Hot MIC Output -ve
10	Auxiliary Loudspeaker Output +ve	23	Auxiliary Loudspeaker Output -ve
11	External Input 2 +ve	24	External Input 2 -ve
12	External Input 1 +ve	25	External Input 1 -ve
13	0V	-	-

Auxiliary audio connector pinout

Note: *When wiring headset 2 to use the auxiliary audio connector, Clear-Com recommends using good quality headphone cable to avoid pickup of electronic noise by the microphone connection.*

Wire the Headset 2 PTTs (pins 4 and 17) so that PTT connects the pin to ground.

The auxiliary loudspeaker output is at line levels, and auxiliary loudspeakers cannot be connected directly. Auxiliary loudspeakers must be driven through a suitable audio amplifier. The line output levels are given in the product specifications.

5.2.11 IrisX panel rear LAN connectors

The LAN connector is an industry standard RJ45 socket that enables you to connect the panel to either a network or the Ethernet port of a PC. This port can support connection of panel to matrix with one, two or three audio channels.

PIN	FUNCTION
1	Transmit data +
2	Transmit data –
3	Receive data +
4	Unused
5	Unused
6	Receive data –
7	Unused
8	Unused

LAN Port
Ethernet RJ-45 Connector

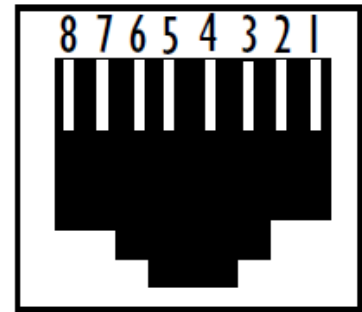

LAN connector pinout

Both Ethernet ports on the IrisX panel are two ports on the internal Ethernet switch. Treat these as you would two ports of any Ethernet switch. That means:

- You can connect either one to your network and all the AoIP and Admin traffic will go through.
- Ethernet traffic is switched from one port to the other, meaning you can daisy-chain equipment.*
- The IrisX panel does not currently support splitting Admin/IVC and AoIP/AES67. This means that the panel can only connect in either IVC mode or AOIP mode.
- You cannot connect both ports to the same network or daisy-chain to a full loop. If you do, your network might go down.
- The IrisX panel does not currently support redundant IP addresses. Therefore even if you connect each port to a different network, you will need to manually change IP addresses to switch from one to the other.

Note: ** From EHX v.13.0 and V-Series IrisX v. 6.51 upwards, V-Series IrisX LAN ports conduct link status monitoring. Due to this, daisy-chaining of panels is NOT supported from these versions. See Link Status Monitoring in this manual.*

Note: *The LAN ports on the Clear-Com IP transceiver have the same set up and follow the same rules as the LAN ports on the IrisX panel, except that the IP transceivers do not support link status monitoring. Daisy chaining is possible, bearing in mind that PTP on the IP transceivers can become unstable as devices are added to the chain. .*

5.2.12 V-Series IrisX Panel - LAN Port Link Status Monitoring

EHX v. 13 and above

In addition to the network redundancy feature (NWR), an IrisX panel will conduct regular link status monitoring on its LAN ports.

The link status of a port tells us whether the port is able to communicate bi-directionally, meaning it can both send and receive data. A link down would indicate that the ethernet cable is unplugged on either end, or otherwise defective. Link status monitoring is conducted by the network switch.

This monitoring happens continually, regardless of whether NWR is enabled on the matrix or the IrisX panel. The panel monitors the link status of LAN 1 and LAN 2 and if either LAN is detected as link status down, transmission will switch to the other port. NWR, if it is enabled, is paused temporarily until both LAN ports' link status is up.

The switch from inactive to active port typically occurs within one second (two seconds max).

Note: *Only one LAN port is active at any time.*

Active network status and history can be viewed in the EHX **Monitoring** screen.

Note: *If the panel is rebooted and only one network connection is detected (only one LAN has link status up), NWR will be disabled on the panel. When the panel connects to the matrix, if NWR is detected in the EHX configuration, NWR will be re-enabled on the panel.*

Clear-Com's proprietary NWR (network redundancy) feature is not the same as ST2022-7. Iris panels do not support ST2022-7

5.2.13 Expansion panel output

V-Series main panels have an industry standard RJ45 socket allowing up to eight V Series expansion panels to be daisy chained from it.

The VI-PNLB-32L panels can only support four VI-EXPB-16L panels.

Master Panel

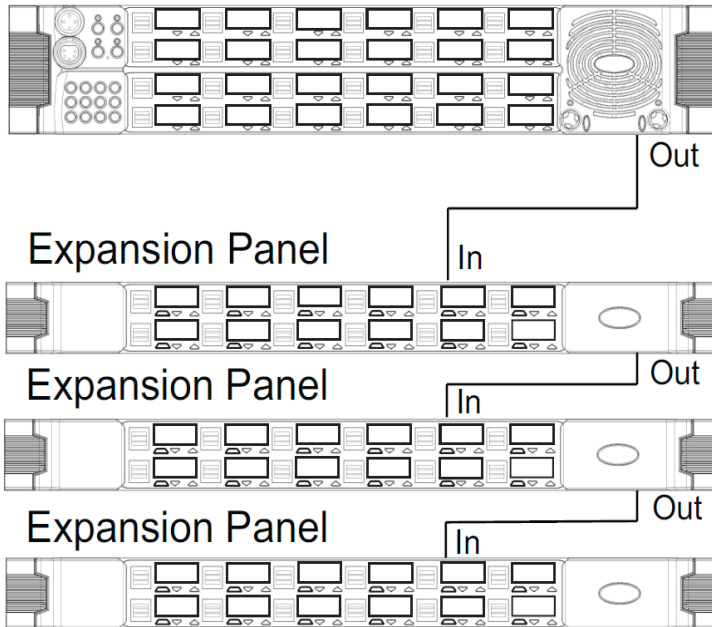

Expansion panel connection

The pinout for the expansion panel cable RJ45 connector is given below.

PIN	FUNCTION
1	Expansion panel detect
2	Expansion panel detect
3	0V
4	Chain length detect
5	Expansion address assign
6	Unused
7	0V
8	Expansion reset

Expansion Port
Ethernet RJ-45 Connector

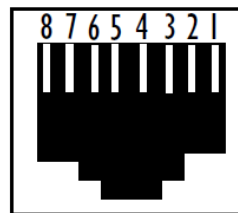

Expansion panel pinout

The CAT5 cables used to connect V Series main panels to expansion panels and expansion panels to further expansion panels are wired as straight through and the same signals are present along the daisy chain.

Each cable connecting a V Series main panel to an expansion panel or an expansion panel to another expansion panel must not exceed 5 meters in length, and the total length of all daisy-chained expansion panels must not exceed 7.5 metres in length.

Note: *If power is removed from an expansion panel within a chain that panel and all expansion panels after it in the chain will no longer work.*

Note: *For connections to Expansion Panels, a ferrite core must be added to the socket end of CAT5 cable. A suitable ferrite core is Fair-rite part: 0431164951.*

5.3 IP connection to matrix

All V-Series panels have a built-in Ethernet/IP interface which can support multiple independent audio channels to an HX Omega, HX Median or HX Delta via an IVC-32 or E-IPA-HX matrix card. When you add a V-Series panel in the EHX Configuration Software, you are prompted to choose the number of additional IP channels that you require, see [Adding one extra IP channel on page 33](#). According to your choice, the EHX software automatically provides the V-Series audio mixer with default settings to make configuration as simple and fast as possible. The default mixer settings reflect the typical user scenarios, but you can also manually adjust the mixer settings in the EHX software to customize your system, or for more advanced requirements. See [Advanced multi IP channel configurations on page 39](#).

This section describes how to implement more than one audio channel via the Ethernet/IP connection. The extra audio channels are typically used to connect to:

- A CCI-22 Interface Module for matrix to 2-wire partyline connections.
- A FOR-22 Interface Module for connecting the matrix to a 2-way radio.
- Headsets. These can be binaural, with or without Push To Talk (PTT).

There are also more advanced options including matrix inputs and mixer control.

There are three connectors on the rear panel of the V-Series panel that can be routed to the matrix via the IP channels. These are labelled:

- Control – this is a DB25 female connector
- Aux Audio – this is a DB25 male connector
- Matrix (Analogue) – this is an RJ-45 connector

Internally, these are represented as EXT0, EXT1 and EXT2. If there is more than one IP channel, EXT0 appears at the Matrix (Analogue) connector at the rear of the panel. When two extra IP channels are added, EXT1 and EXT2 are on the cable assembly used to implement the added IP channels. If there is only one IP channel, EXT1 and EXT2 appear at the Control and Aux. Audio connectors on the rear of panel.

The following sections describe the workflow for typical scenarios where one or two extra IP channels are required. There is also a section describing more advanced configurations. See also, the Eclipse HX Configuration Software Manual.

5.3.1 Adding one extra IP channel

This is typically used if you want to configure the extra IP channel to connect to a 4-wire interface, or to an analogue or digital partyline. To add on extra IP channel:

1. From the EHX software, navigate to Cards and Ports > IVC-32 > Port Function and add the V-Series Panel. The following screen appears:

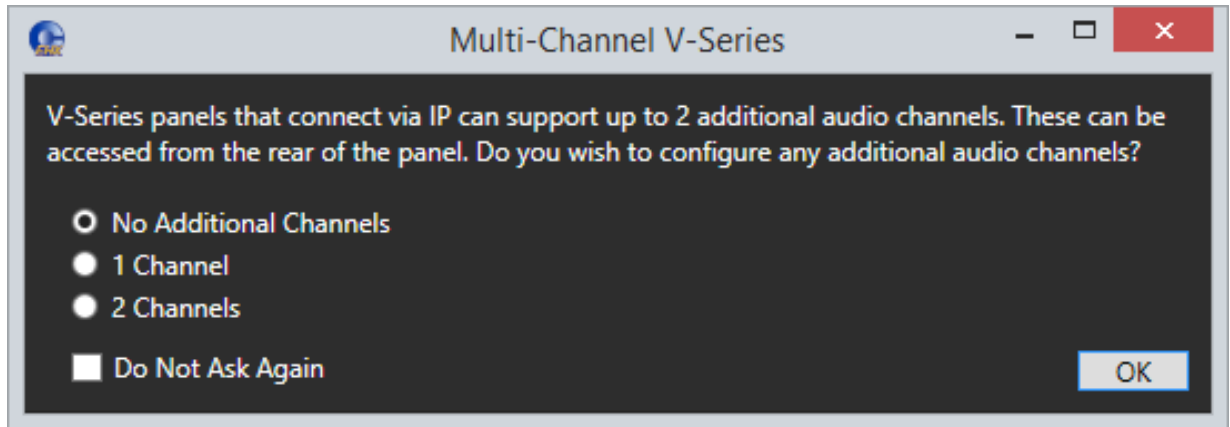

2. Select 1 Channel. A port labeled Hosted Direct appears under the V-Series Panel.
3. The Audio Mixer settings automatically set the default layout for one extra IP channel.

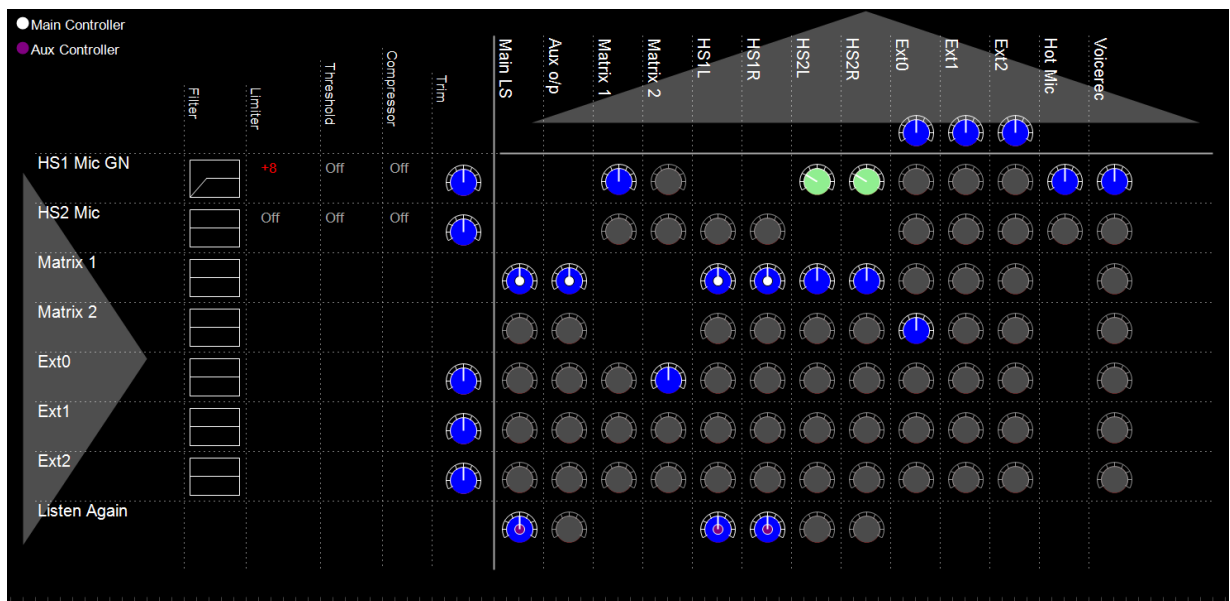

Matrix 2 is the added Hosted Direct channel. The default single IP channel mixer setting has matrix 2 audio routed to and from Ext 0. For more information about the Audio Mixer, see the Eclipse HX Configuration Software User Guide.

Note: *EXT 0 on the panel uses the analog RJ45 port on a matrix.*

Note:

If required, you can change the default settings. See [Advanced multi IP channel configurations on page 39](#)

4. Connect the V-Series Panel EXT0 connector to the FOR-22, CCI-22 or HelixNet unit using an RJ-45 crossover cable. The pinouts are shown below.

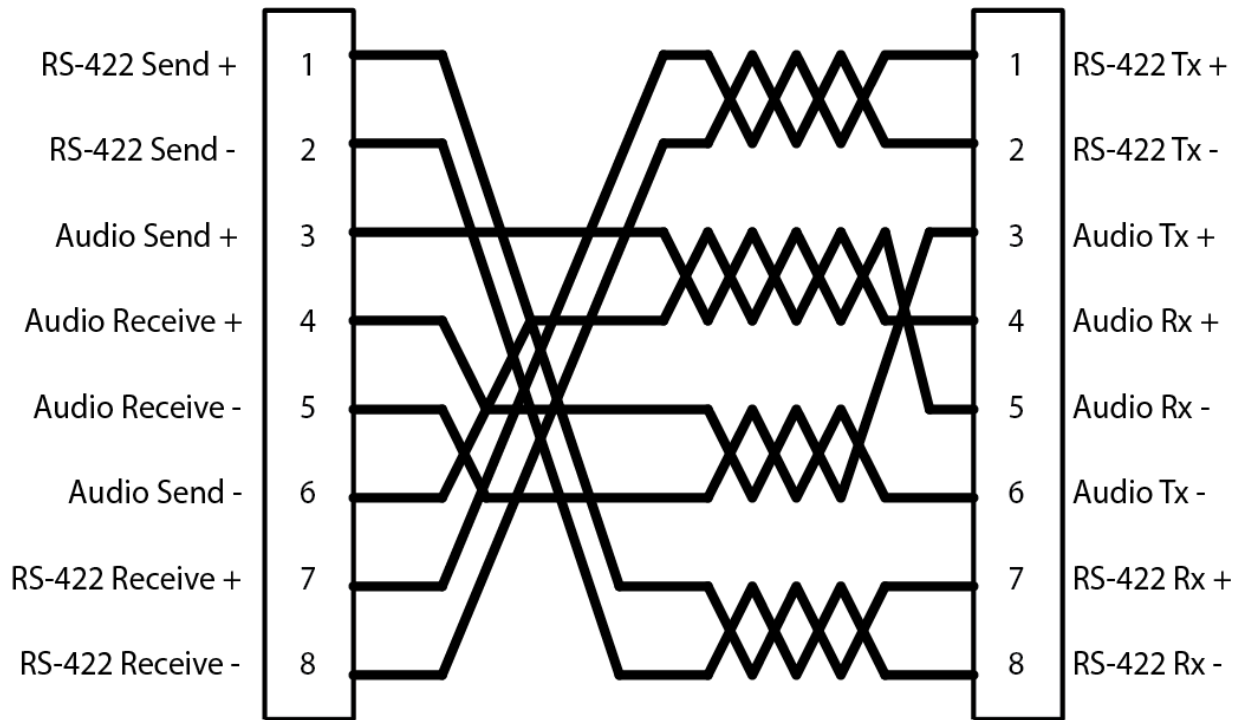

EXT0 connector RJ-45 crossover cable pinouts

LAN1 and LAN2 Ethernet RJ-45 Connectors

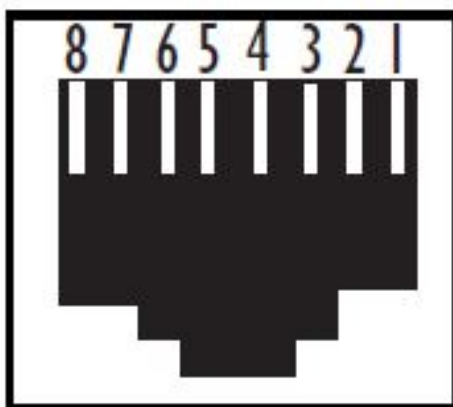

RJ-45 connector

By default, the extra IP channel is configured as Direct, which is used for a 4-wire connection. You can change this to make it suitable for a different application.

5. In the EHX software, navigate to Cards and Ports, and select the added IP port.
6. From the right-hand side of the window, select Basic Options.
7. From the Module Application list box, select from
 - Partyline – to connect to an analogue partyline using the CCI-22 Interface Module.
 - Two-Way Radio – to connect to a third-party two-way radio system by using the FOR 22 Interface Module.
 - Direct – to connect to a 4-wire interface.
 - HelixNet – to connect to the digital HelixNet partyline.

A partyline, two-way radio or HelixNet interface connected to EXT 0 in this way provides the same functionality as the same interface connected directly to an MVX port, for example call signaling Tx and Rx in the case of the Partyline port application setting.

5.3.2 Adding two extra IP channels

This is typically used if you want to configure two extra IP channels to connect to a 4-wire interface, or to an analogue or digital partyline.

This configuration requires a cable assembly. Clear-Com support can assist in the sourcing of this and similar cables.

To add two extra IP channels:

1. From the EHX software, navigate to Cards and Ports > IVC-32 > Port Function and add the V-Series Panel. The following screen appears:

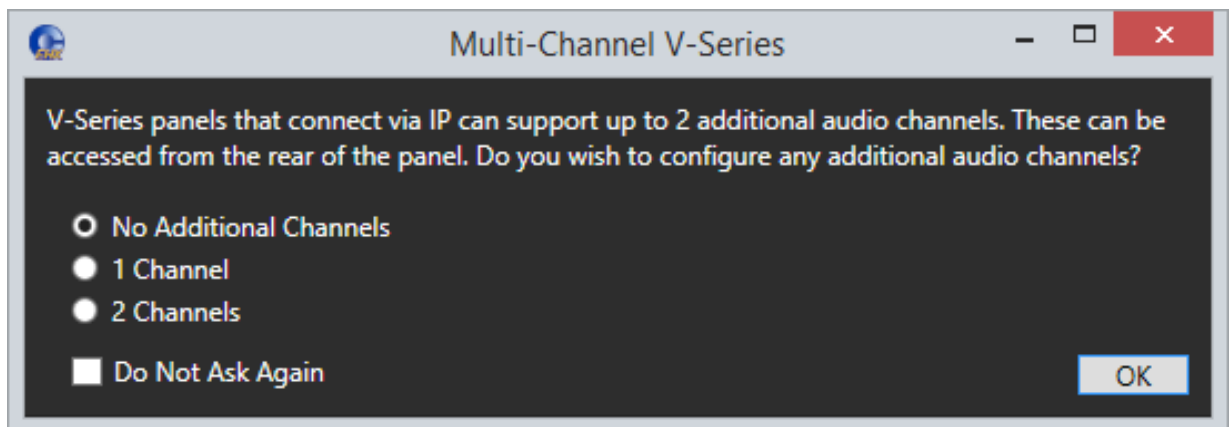

2. Select 2 Channels. Two ports labeled Hosted Direct appear under the V-Series Panel.
3. The Audio Mixer settings automatically set the default layout for one extra IP channel.

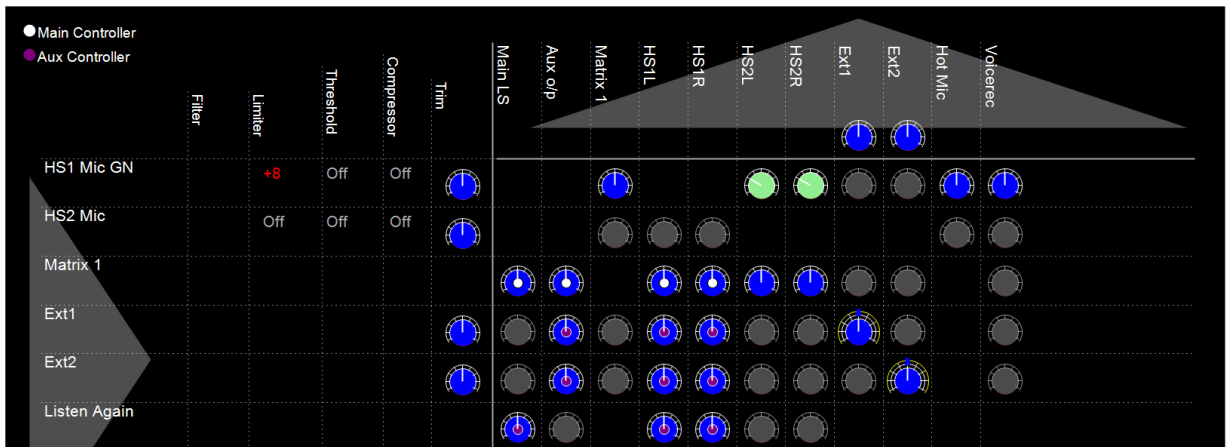

Matrix 2 and Matrix 3 are the additional IP connections to the E-IPA or IVC-32. The default mixer settings when two additional channels are selected are to route Ext 0 to/from Matrix 2 and Ext 1 to/from Matrix 3. This routing can be changed using the Audio Mixer. For more information about the Audio Mixer, see the Eclipse HX Configuration Software User Guide.

Note: If required, you can change the default settings. See [Advanced multi IP channel configurations on page 39](#).

4. Connect the V-Series Panel Matrix EXT0 port to the one of the endpoint devices using an RJ-45 crossover cable. The pinouts are shown in the section above.
5. Connect the third-party cable harness as follows:
 - Male DB-25 connector to Control on V-Series panel
 - Female DB-25 connector to Aux.Audio on V-Series panel.
 - The pinouts for this connector are shown on the next page.

By default, the extra IP channels are configured as Direct, which is used for a 4-wire connection. You can change this to make it suitable for a different application.

1. In the EHX software, Navigate to Cards and Ports, and select the added IP port.
2. From the right-hand side of the window, select Basic Options.
3. From the Module Application list box, select from
 - Partyline – to connect to an analogue partyline by using the CCI-22 Interface Module.

- Two-Way Radio – to connect to a third-party two-way radio system by using the FOR 22 Interface Module.
- Direct – to connect to a 4-wire interface.
- HelixNet – to connect to the digital HelixNet partyline.

By default, the extra IP channel is configured as Direct, which is used for a 4-wire connection. You can change this to make it suitable for a different application.

A partyline, two-way radio or HelixNet interface connected to EXT 0 in this way provides the same functionality as the same interface connected directly to an MVX port, for example; call signaling, Tx and Rx, in the case of the Partyline port application setting.

With this default mixer setting FOR-22 or CCI-22 can be connected to EXT0 and EXT1. This setting supports both Call signaling and/or PTT signaling to the external device.

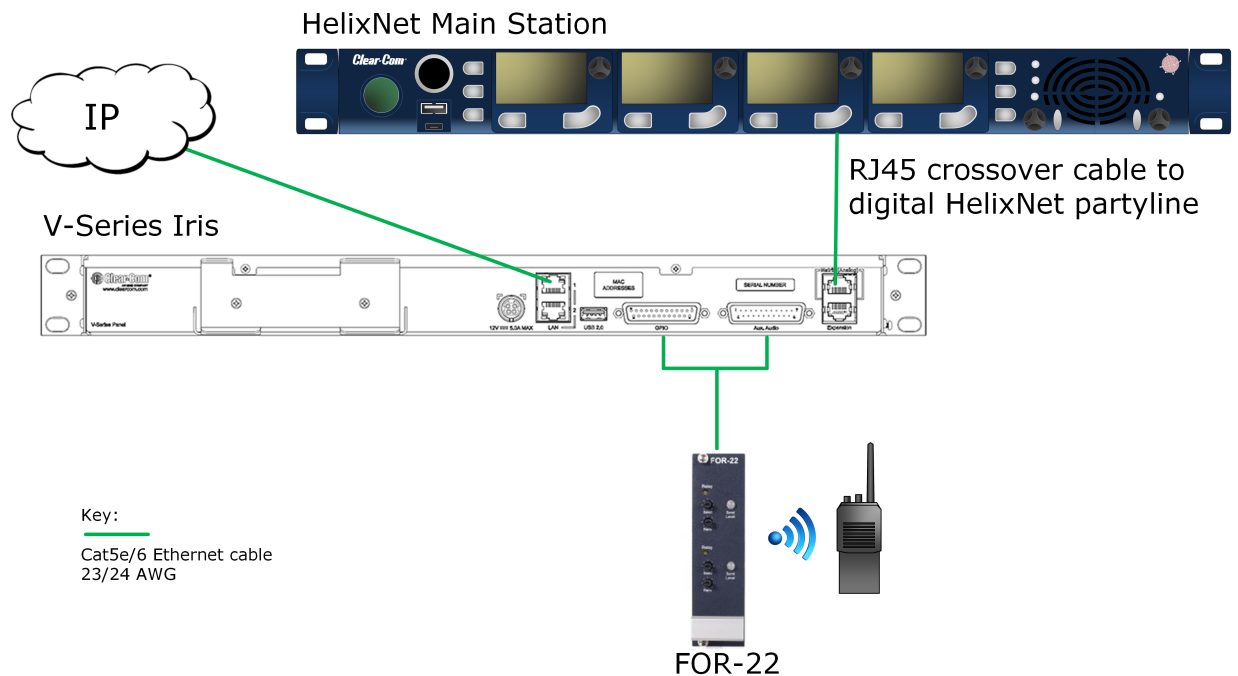

Example of cabling for a system using auxiliary audio

5.3.3 FOR-22 and CCI Connections

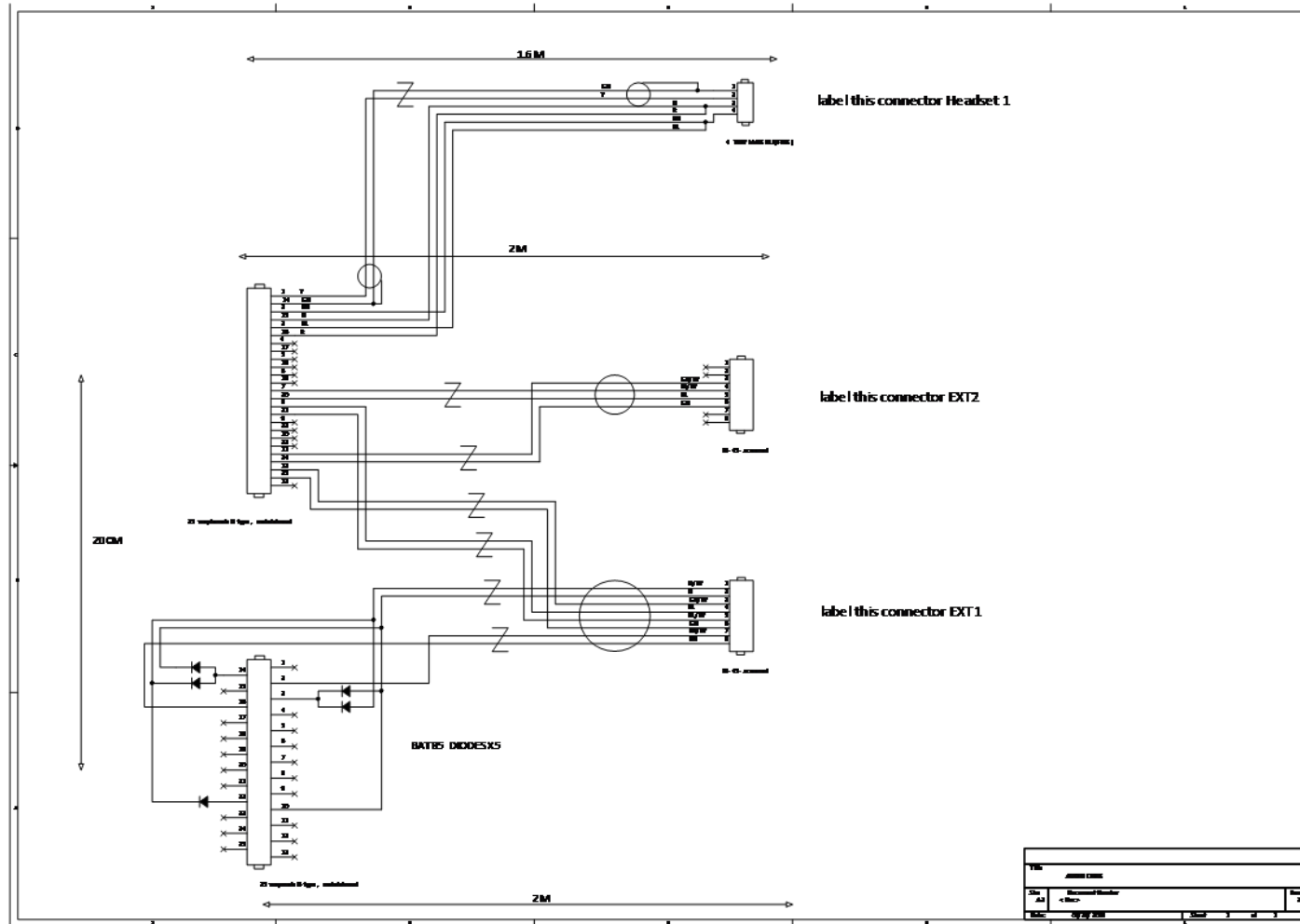

FOR-22 and CCI-22 connections for EXT0 and EXT1

5.3.4 Binaural audio

If you configure the panel for binaural audio, the following default mixer settings appear in the panel Audio Mixer. This mode is useful for situations when you require separate audio channels in the left and right headphone inputs.

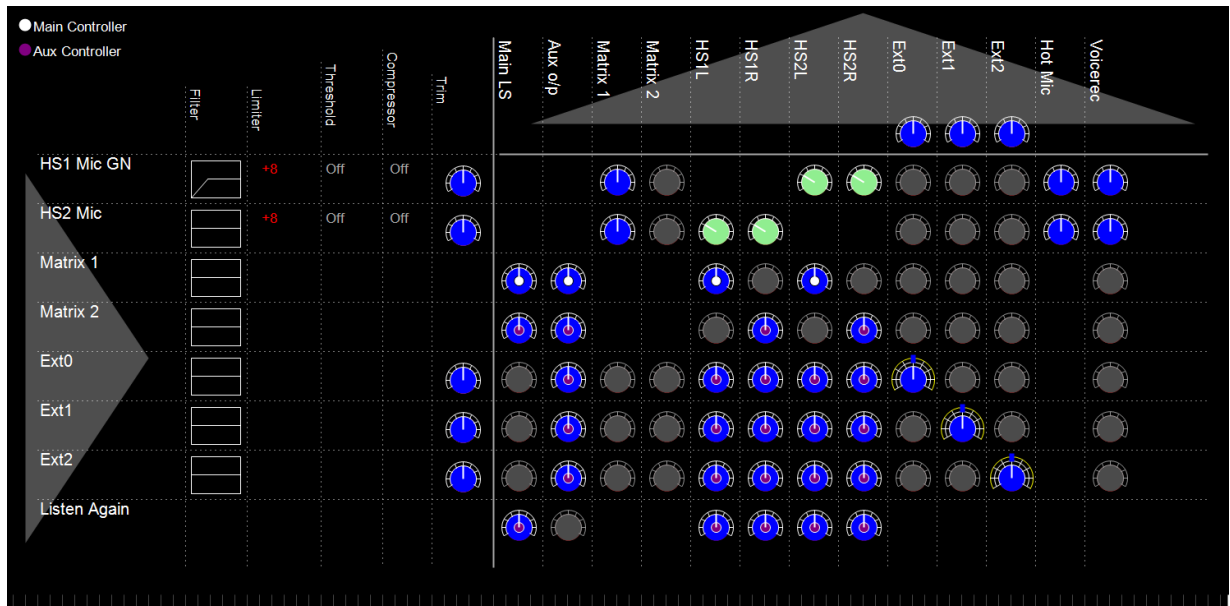

5.3.5 Advanced multi IP channel configurations

The additional one and two IP channel configurations automatically activate default settings in the Audio Mixer when they are selected in the EHX software. You can change these default settings to create a custom configuration. For example, you can change the default routing in the Audio Mixer.

When port applications other than direct are selected for the hosted ports panel, GPIOs will be automatically allocated by the software to provide the requested functionality, for example call signal in the case of partyline. These GPIOs will continue to be available in the EHX GPI and GPO screens and the logic of the parallel usage will be OR'd.

For more information about using the Audio Mixer, see the EHX Configuration Software User Guide.

5.4 Redundant Network Connections

EHX v.13.0 and upwards.

Note: Before implementing a redundant network, you must purchase a redundant network feature license (E-IPA-RDT-NET-HX) for each E-IPA card you intend to use in the network. See **E-IPA Card > Licenses**, in the EHX Software Configuration User Guide.

In EHX it is possible to configure a redundant network connection. This allows you to enable a switch to a backup LAN port in the event of a network failure. In order to gain the most from this feature your network must be designed for redundancy, for example, a network using a Spanning Tree Protocol.

Each Clear-Com device that supports this feature can be configured to ping up to two IP addresses to test the network. To avoid single point-of-failure it is advisable to configure both test IP addresses, (the feature will work with one). If there is no response to the test pings (both IP addresses) for a time configurable in EHX, the device will switch to the backup LAN connection.

A redundant network connection can be set up for the following IP endpoints and interface cards:

- V-Series IrisX panels
- E-IPA-HX card (AoIP and IVC-32 connections)

Failover Timeout

A switch to the backup LAN occurs after a configurable time for which there is no response to the test pings. This configurable time is termed the **Failover Timeout**.

In order to balance failure response time and stability (preventing systems entering endless switch over loops), the network redundancy feature has a fixed 60 second suppression period. This means that after a switch over or a system reset the system cannot switch LAN connection for 60 seconds.

5.4.1 Example network set up:

Eclipse HX Network Redundancy (LAN/WAN)

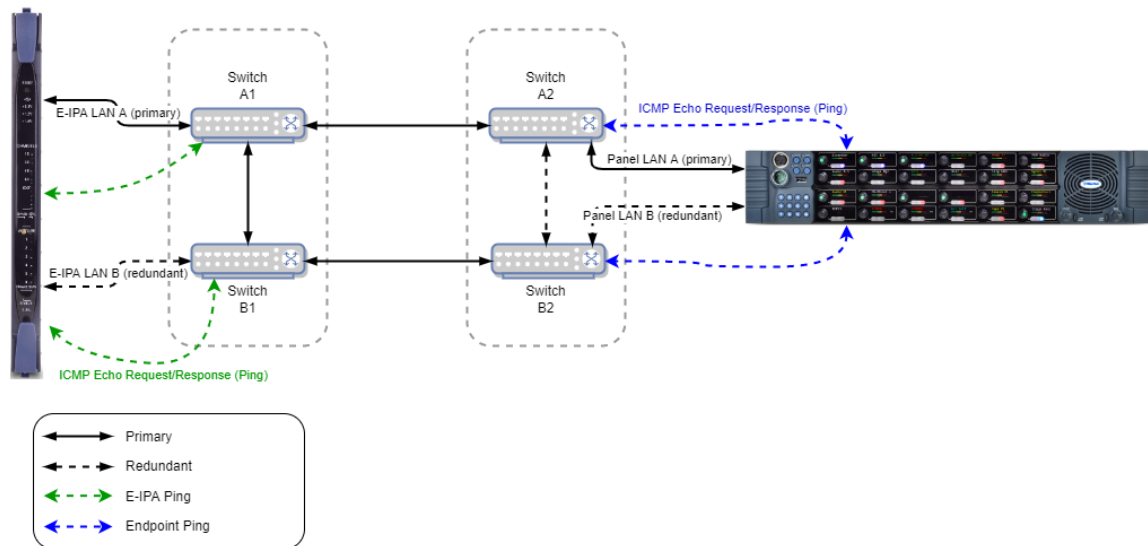

5.4.2 Configure Redundant Network Connections

Overview. To configure a redundant connection you will:

- Enable the redundant network option in device properties
- Select a LAN connector for the redundant network (E-IPA only)
- Configure two reliable ping destinations
- Configure the failover timeout
 - E-IPA card: between 5 and 300 seconds
 - IrisX panel: between 10 and 300 seconds
- Apply map to matrix

Note:

The IrisX panel will monitor link status on each LAN port, as well as monitoring the ping destinations.

Configure a redundant network connection: E-IPA card

Navigate to **Matrix > Hardware > Cards and Ports > E-IPA card** > right click on the E-IPA card and select **Card Properties**. Set the **Network Redundancy Options**:

1. Set the **Test IP Address** and **2nd Test IP Address**.
2. Select the **Alt Rear Connection** (the LAN port that will carry the redundant network)

3. Set the **Failover Timeout** (5 - 300 seconds).
4. Apply map to matrix.

E-IPA-HX Card Properties

Use IVC settings for Admin connection

E-IPA-HX Port License:

Redundancy Mode: No redundant card available

View card license: [Open in browser](#)

Admin and IVC | AoIP | Protocol Settings | C < >

Rear Connection:

DHCP Enabled:

IP Address:

Subnet Mask:

Default Gateway:

Multicast Start Addr:

Network Redundancy Options

Test IP Address:

2nd Test IP Address:

Alt. Rear Connection:

Failover Timeout (s):

Please note, changing Card Properties will cause an E-IPA card reboot following the next 'Apply Changes'. (E-IPA reboot can take up to 3 minutes).

The AoIP network interface must use static IP addresses when AoIP ports are allocated.

Please refer to the Clear-Com Network Recommendations document which contains important information about configuring your IP Network infrastructure for use with Eclipse-HX.

Configure a redundant network connection: V-Series IrisX panel

Navigate to **Matrix > Hardware > Cards and Ports > select panel > Panel Properties > IP Port Options** and set the following:

1. Click the to enable the **Redundancy Enabled** checkbox.
2. Set the **Test IP Address** and **2nd Test IP Address**.
3. Set the **Failover Timeout** (10 - 300 seconds).
4. Apply map to matrix.

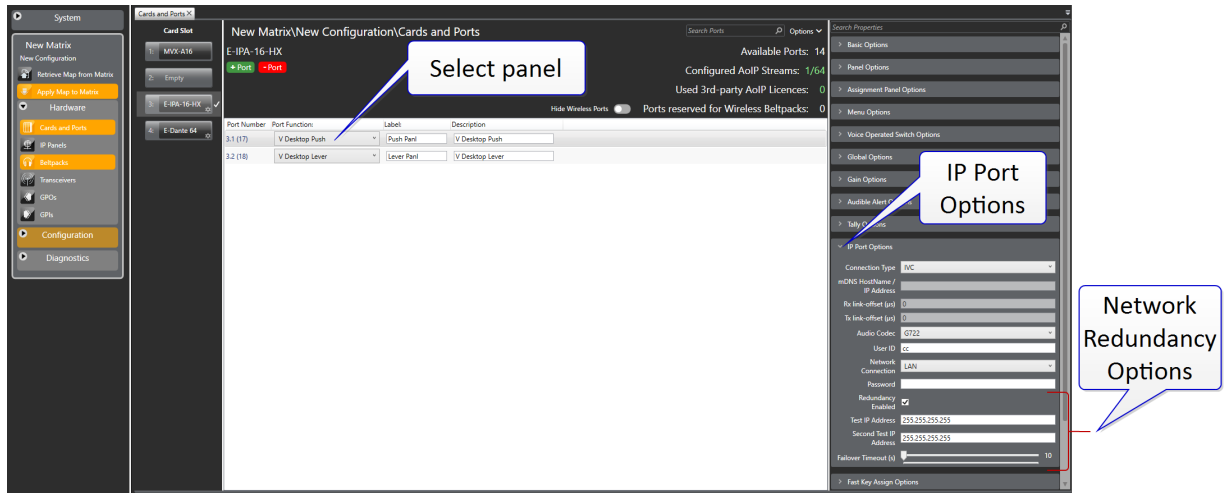

Configure a redundant network connection: IP transceiver (FreeSpeak II, FreeSpeak Edge)

Navigate to **Matrix > Hardware > Transceivers > select transceiver > Properties > IP Port Options** and set the following:

1. Click the to enable the **Redundancy Enabled** checkbox.
2. Set the **Test IP Address**.
3. Set the **Failover Timeout** (5 - 300 seconds).
4. Apply map to matrix.

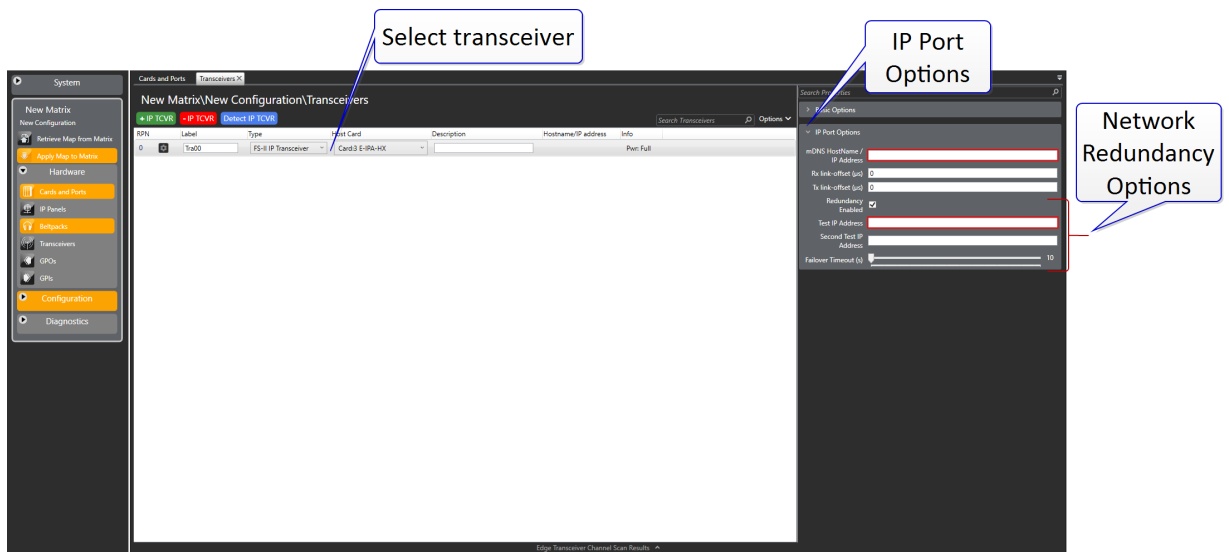

5.4.3 Monitoring Network Redundancy

Navigate to **System > Monitoring** [detail view]. In the monitoring screen, select the required device. Current LAN connections, network redundancy (**NWR**) switchovers and history can be viewed in the right hand section of the screen. **History** shows events that have occurred since the device was last booted up. A device reboot will clear the history.

The screenshot displays the 'Monitoring' interface for a V-Series 1RU Level: IVP. The main area shows a grid of network cards and their status. A callout box labeled 'Select panel' points to the '161: V-Series 1RU Level: IVP' card, which is highlighted in green. To the right, a detailed view for this card shows 'Additional Details' with 'LAN Port: NWR switches: 2' and 'Main' selected. Below this is a 'History' table showing network events.

2 network switches have occurred and the main LAN is currently active

At 2:47 pm the network switched to the backup LAN

At 2:55 pm the network switched back to the main LAN

Time	Status	Event
21/09/2022 01:23:49 PM	Unknown	NC Connection
21/09/2022 01:25:33 PM	Down	VoIP Status
21/09/2022 01:31:54 PM	Unknown	NC Connection
21/09/2022 02:34:55 PM	Up	VoIP Status
21/09/2022 03:34:07 PM	LAN Main	NWR Status
21/09/2022 03:34:07 PM	Good	NC Connection
21/09/2022 03:25:27 PM	LAN Main	NWR Status
21/09/2022 03:25:27 PM	Good	NC Connection
21/09/2022 02:46:10 PM	Down	VoIP Status
21/09/2022 02:46:10 PM	Unknown	VoIP Status
21/09/2022 02:47:27 PM	Up	VoIP Status
21/09/2022 02:47:27 PM	LAN Backup	NWR Status
21/09/2022 02:47:27 PM	Good	NC Connection
21/09/2022 02:47:27 PM	LAN Backup	NWR Status
21/09/2022 02:47:27 PM	Down	VoIP Status
21/09/2022 02:47:27 PM	Absent	NC Connection
21/09/2022 02:54:36 PM	Up	VoIP Status
21/09/2022 02:54:36 PM	LAN Main	NWR Status
21/09/2022 02:54:36 PM	Good	NC Connection
21/09/2022 02:54:36 PM	Down	VoIP Status
21/09/2022 02:54:36 PM	Absent	NC Connection
21/09/2022 02:54:36 PM	LAN Main	NWR Status
21/09/2022 02:54:36 PM	Good	NC Connection
21/09/2022 02:54:36 PM	Down	VoIP Status
21/09/2022 02:54:36 PM	Absent	NC Connection
21/09/2022 02:54:36 PM	LAN Main	NWR Status
21/09/2022 02:54:36 PM	Good	NC Connection
21/09/2022 02:54:36 PM	Down	VoIP Status
21/09/2022 02:54:36 PM	Absent	NC Connection
21/09/2022 02:54:36 PM	LAN Main	NWR Status
21/09/2022 02:54:36 PM	Good	NC Connection

5.4.4 V-Series IrisX Panel - LAN Port Link Status Monitoring

EHX v. 13, V-Series IrisX panel v. 6.51 and above

In addition to the network redundancy feature (NWR), an IrisX panel will conduct regular link status monitoring on its LAN ports.

The link status of a port tells us whether the port is able to communicate bi-directionally, meaning it can both send and receive data. A link down would indicate that the ethernet cable is unplugged on either end, or otherwise defective. Link status monitoring is conducted by the network switch.

This monitoring happens continually, regardless of whether NWR is enabled on the matrix or the IrisX panel. The panel monitors the link status of LAN 1 and LAN 2 and if either LAN is detected as link status down, transmission will switch to the other port. NWR, if it is enabled, is paused temporarily until both LAN ports' link status is up.

The switch from inactive to active port typically occurs within one second (two seconds max).

Note: *Only one LAN port is active at any time. Therefore, it is not possible to daisy-chain panels when using EHX v.13 and above.*

Active network status and history can be viewed in the EHX **Monitoring** screen.

Note: *If the panel is rebooted and only one network connection is detected (only one LAN has link status up), NWR will be disabled on the panel. When the panel connects to the matrix, if NWR is detected in the EHX configuration, NWR will be re-enabled on the panel.*

5.4.5 V-Series IrisX Panel - IP Port Lockdown

EHX v. 13 and above

This is a security feature that allows you to lock down all IP ports on panels that are not essential for audio transmission. IP port lockdown can be enabled in EHX system **Preferences**. Once enabled, all the panels connected to a matrix have inessential IP ports blocked. A single panel can be unlocked from it's front panel menu, but as long as IP security is enabled in system preferences, the ports will be blocked again when the panel is rebooted and reconnects to the matrix.

The following ports are blocked when this feature is enabled:

- UDP 5000: IP (IVC) panel discovery
- UDP 67: DHCP
- UDP 68: DHCP
- UDP 5353: mDNS
- TCP 80: CCM
- TCP 8080: alternative http port
- TCP 443: CCM https
- TCP 873: usually resync.

Enable Panel IP Port Lockdown

1. In EHX, navigate to: **Matrix > Configuration > Preferences > IP Panels > IP Security** and click the checkbox to enable this feature.
2. **Apply Map to Matrix.**

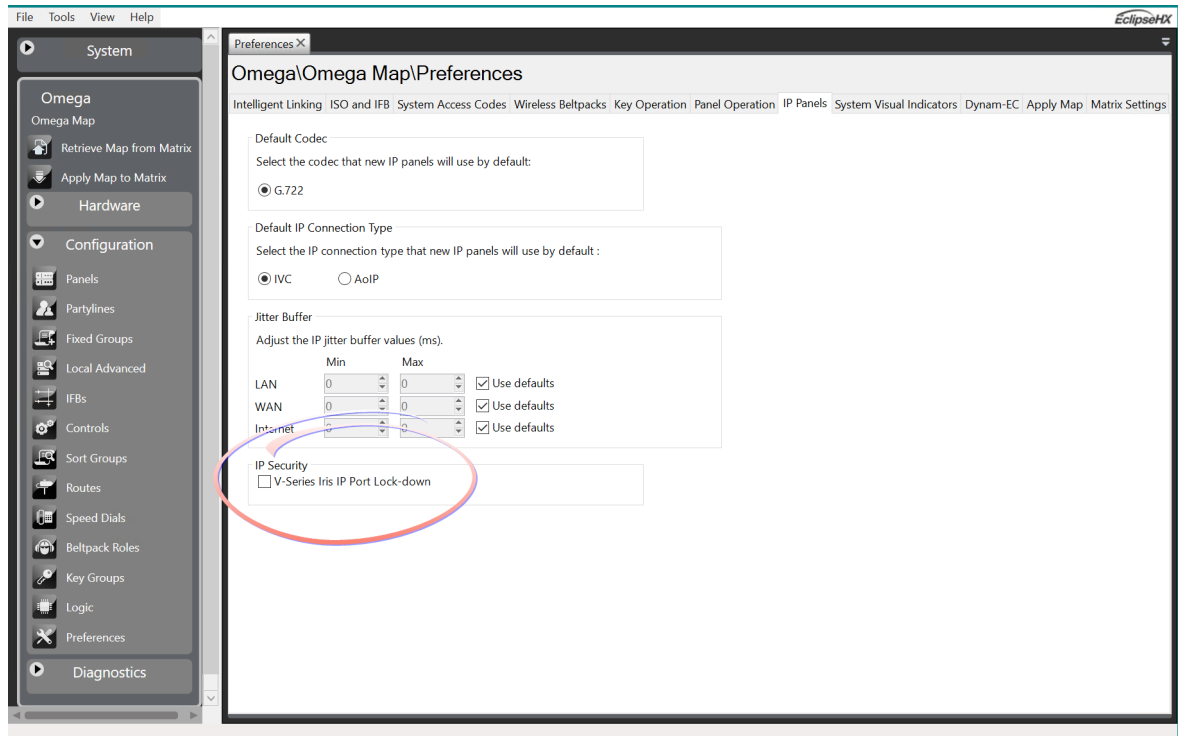

All panels that are connected (or will be connected) to the matrix have inessential ports blocked.

Unlock Panel IP Ports

There are two ways to unlock this feature:

- In EHX, navigate to **Matrix > Configuration > Preferences > IP Panels > IP Security**. Click the checkbox to clear the checkmark and disable this feature. **Apply Map to Matrix**. All panels connected to the matrix are now unlocked.
- From the panel go to **Menu > IP SetUp > Clear**. This unlocks IP ports for this panel. When the panel is reset, it will reconnect to the matrix and IP security will be enabled again (assuming the security feature is still enabled in system preferences).

5.5 Front panel connectors

The V-Series main panels have a microphone connection and a headset connection on the front.

The microphone connection is always a three pin socket while the headset connector may be an XLR-4M, XLR-5F or XLR-7M connector.

The pinouts for the connectors are given below.

5.5.1 Microphone connector

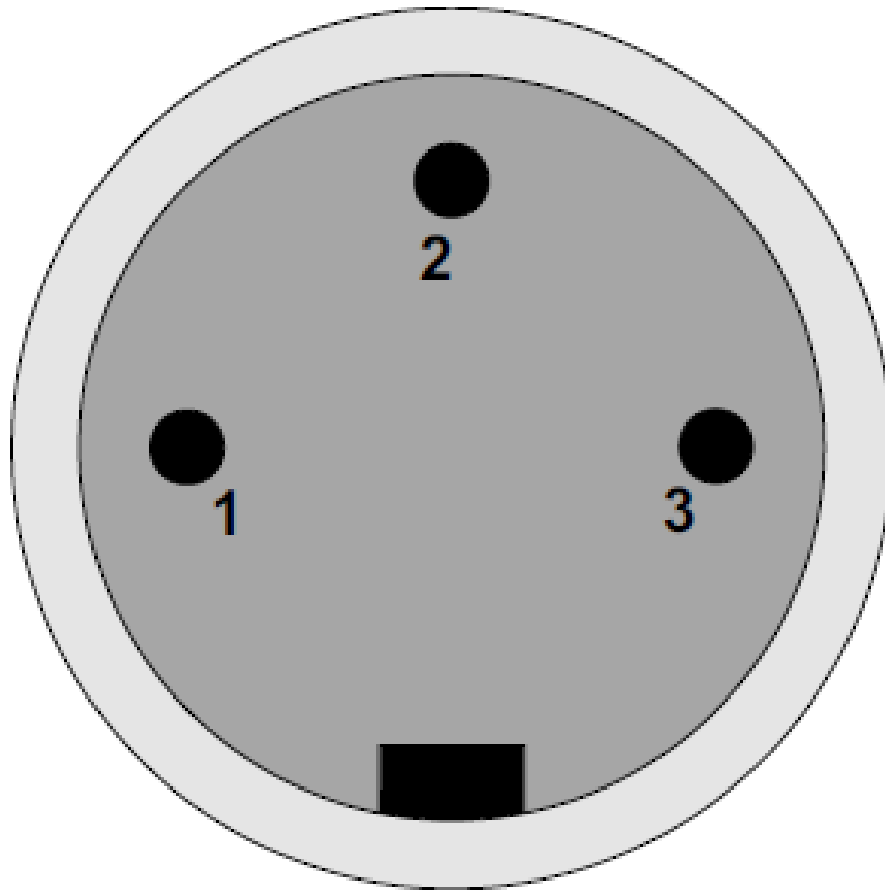

Microphone connector

Pin	Description / comments
1	Screen
2	Microphone input +
3	Microphone input -

Microphone connector pinouts

Note: Configuration of the wrong type of microphone or headset will degrade or nullify the audio from the panel or worse still, damage the microphone or headset.

5.5.2 Headset connectors

The headset connector may be one of three types: XLR-4M, XLR-5F or XLR-7M.

The pinouts for each type are shown below.

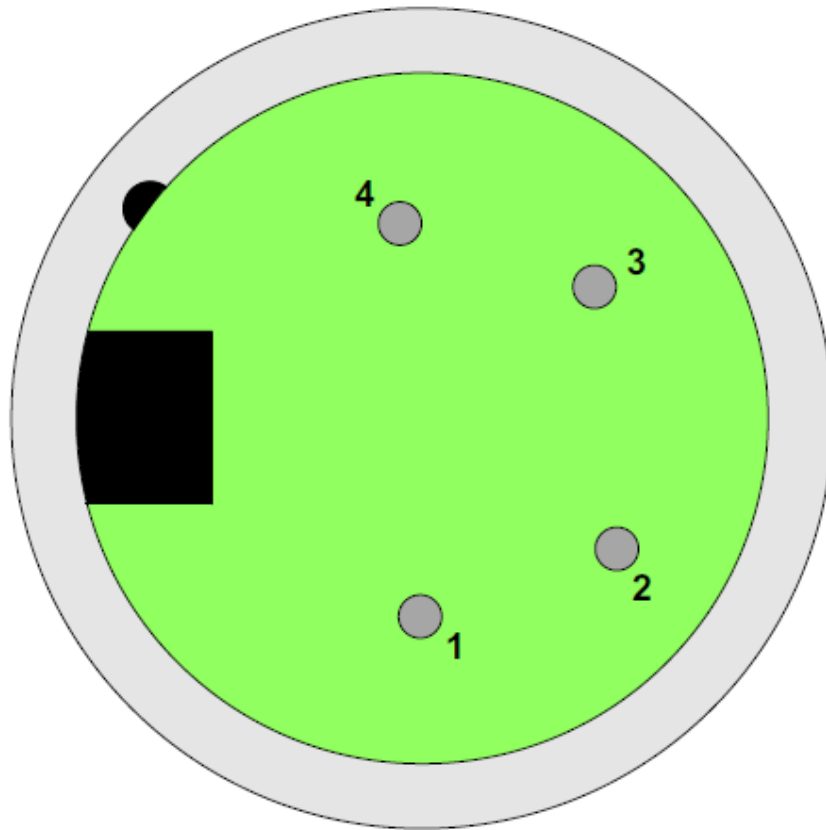

XLR-4M microphone connector

Pin	Description
1	Microphone Screen
2	Microphone Input
3	Headphone Return
4	Headphone Output

XLR-4M headset connector pinout

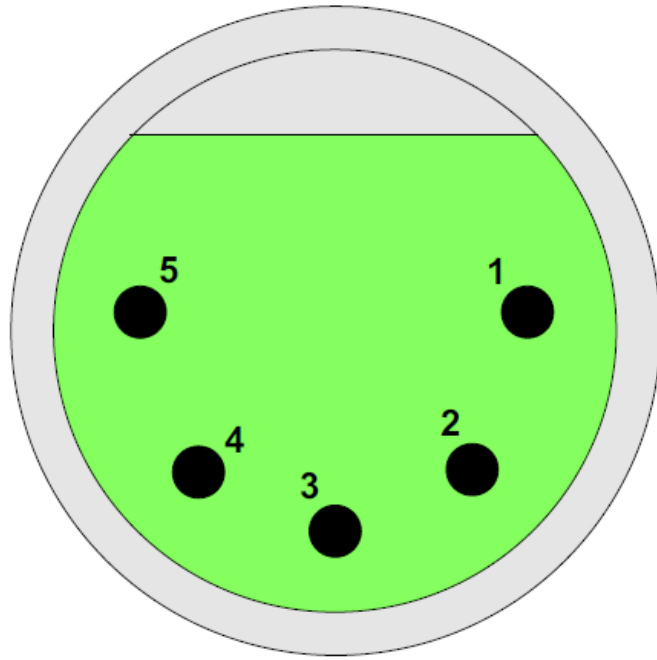

XLR-5F microphone connector

Pin	Description
1	Microphone Screen
2	Microphone Input
3	Headphone Return
4	Left Headphone Output
5	Right Headphone Output

XLR-5F headset connector pinout

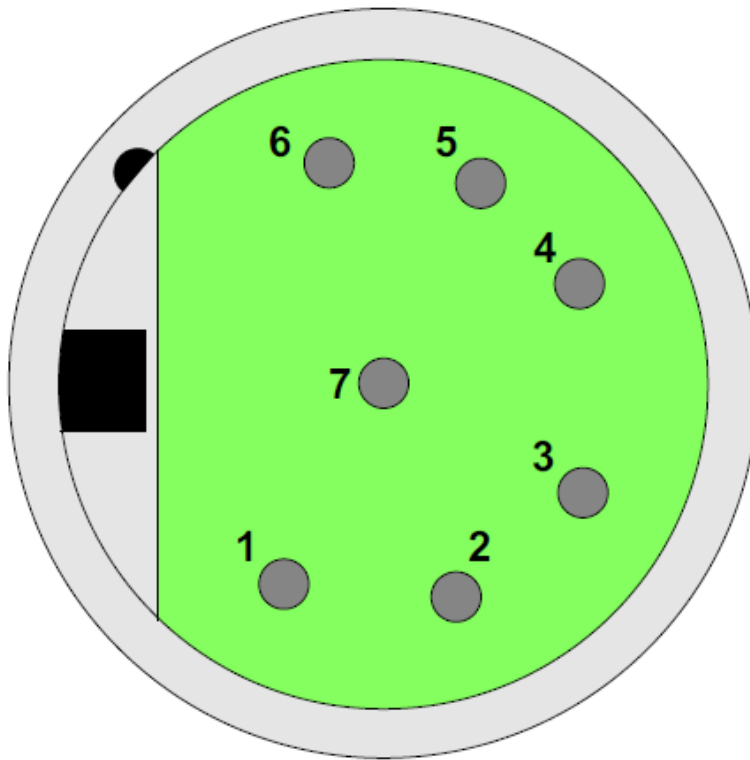

XLR-7M microphone connector

Pin	Description
1	Microphone -ve
2	Microphone +ve
3	Ground
4	Left Headphone Output
5	Right Headphone Output
6	PTT1
7	PTT2

XLR-7M headset connector pinout

The V-Series panels have two GPI inputs called logic 1 and logic 2. They can be used for PTT actions or wired to foot-switches for example.

The logic 1 can be physically accessed via the rear DB25 socket labelled GPIO connector OR the XLR 7 front headset socket. Both inputs are wired in parallel

The logic 2 can be physically accessed via the rear DB25 socket labelled GPIO connector OR the XLR 7 front headset socket. Both inputs are wired in parallel

They are configured in the EHX software as follows:

- 1) Select **Hardware > Cards and Ports**.
- 2) Select the required port.
- 3) Select **Logic Input Options**.

The screenshot shows the 'Logic Input Options' configuration window. It contains the following settings:

Logic Input	Function	Action Destination	Action Type
Logic Input 1	No Function		None
Logic Input 2	No Function		None
Logic Input 3	Reply Key		
Logic Input 4	Exit Supervisor Mode		

Configuration of the wrong type of microphone or headset will degrade or nullify the audio from the panel or worse still, damage the microphone or headset.

The PTT1 and PTT2 functions on an XLR-7 headset or a second headset connected via the auxiliary audio connector are connected to the logic 1 and logic 2 inputs in the EHX Configuration software (Cards and Ports).

Headset 1 PTT 1 or headset 2 PTT 1 active will have the same effect as Logic 1 active.

Headset 1 PTT 2 or headset 2 PTT 2 active will have the same effect as Logic 2 active.

PTT is activated by grounding the PTT line.

5.6 Placing expansion panels

You can install the following optional, accessory key panels:

- The VI-EXPB-12P Pushbutton Expansion Panel adds 12 pushbutton talk/listen selectors to a panel.
- The VI-EXPB-12R Rotary Expansion Panel adds 12 rotary talk/listen selectors to a panel.
- The VI-EXPB-16L Lever Key Expansion Panel adds 16 lever key talk/listen selectors to a panel.

The installation procedure is identical for these panels.

Expansion panel types (lever key, pushbutton or rotary) may not be mixed in a daisy chain of such panels and must be connected to a main panel of the same type.

The VI-EXPB-16L expansion panel can only be used with the VI-EXPB-32L panel.

Only one rack unit (1RU) of a standard Electronics Industry Association equipment rack is required for each expansion panel. The panels' compact size makes them ideal for use in TV control rooms, edit suites, mobile OB vans, and any other location where many talk/listen keys are necessary but space it at a premium.

All panels provide 12 or 16 additional selectors with displays.

5.6.1 Mounting

All accessory panels are mounted in a standard 19-inch wide (48.3 cm) standard Electronics Industry Association rack, requiring one unit of rack space each. Leave at least 2 in. (51 mm) of clearance behind the rear of the chassis to allow for cable connectors.

5.6.2 Power

Each expansion panel is powered by an external power supply which may be mounted on the back of the panel using the mounting clip provided. To connect the power supply to an expansion panel, route the transformer's output lead to the power connector on the back of the panel. This is a 4 pin connector.

5.6.3 Panel connection

A cable is supplied with each panel to connect it to a main panel or to additional expansion panels. The cable is a 6-ft. long (1.8 m) CAT5 cable with RJ45 connectors at each end. If custom length cables are to be made, they should be made with cable with 22 to 24 AWG wire. The pins should be wired one-to-one between the RJ45 connectors. The maximum distance between the panel and the last expansion panel should be 25 ft. (7.6 m).

To connect an expansion panel to a main panel:

1. Plug one end of the CAT5 cable into the RJ45 expansion socket on the back of the main panel.
2. Plug the other end of the CAT5 cable into the input connector on the back of the expansion panel.

To connect an additional accessory panel:

1. Plug the CAT5 cable into the output connector of the last expansion panel in the chain.
2. Plug the other end of the CAT5 cable into the input connector of the new expansion panel. More panels can be added by using this daisy-chaining method.

The numbering of expansion selectors follows the order of the daisy chaining.

5.6.4 Panel configuration

After physically placing the expansion panels and connecting them to a main panel, the expansion panels must be programmed in EHX

For more information, see your EHX documentation.

5.7 Panel parameters in EHX

The following panel parameters are adjustable by selecting options in EHX:

- Panel Headset Microphone Gain
- Headset 2 Microphone Gain
- Panel Microphone Gain
- Input Level (Volume)
- Output Level (Volume)
- Aux Level (Volume) Off Limit
- Main Level (Volume) Off Limit
- Speaker Dim
- Page Volume Level
- Headset Detect
- Loudspeaker Cut

All these parameters are set to factory defaults. Most panels should operate at these default setting. However, some applications may required adjustment.

5.7.1 Headset sidetone

Sidetone is the sound of the user's voice in his headset.

For information about adjusting sidetone, see your EHX documentation.

5.7.2 Headset autodetect

V-Series panels can autodetect headsets 1 and 2 and automatically enable them. Headset auto detect can be set to enabled or disabled via a DIP switch (SW4) on the main board. As headset insertion can cause a noise on the panel some users may wish to disable automatic headset detect and use the front panel button instead to enable and disable the headsets.

To access the DIP switch the top cover must be removed from the panel.

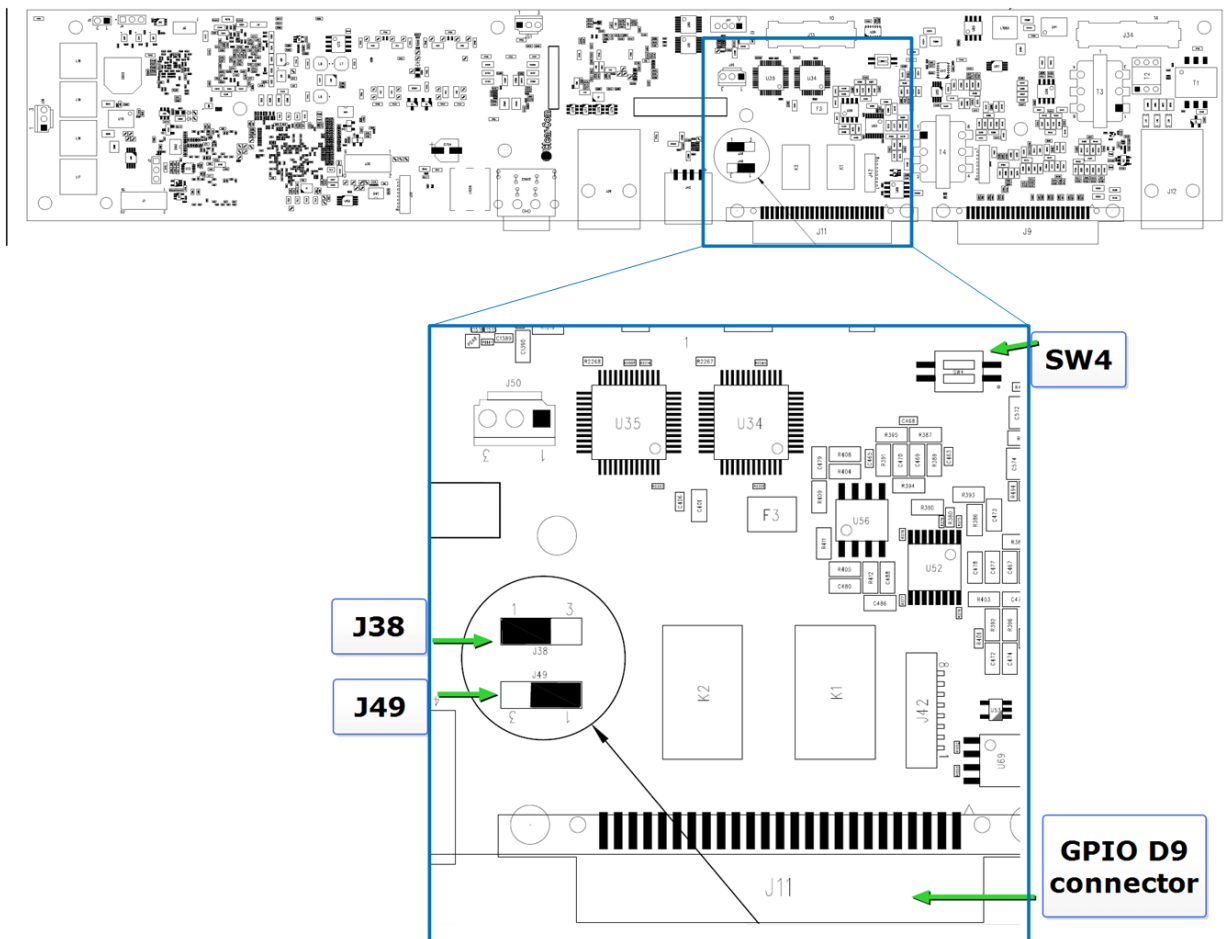

Headset autodetect DIP switch (SW4)

Headset 1 autodetect is controlled by switch 1 on SW2 and headset 2 autodetect is controlled by switch 2 on SW4.

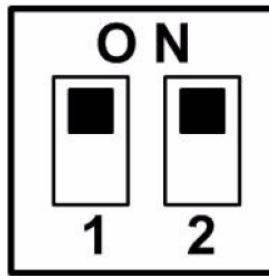

Headset autodetect DIP switch settings

To enable headset auto detect for a headset set the appropriate switch to ON (towards the front of the panel).

To disable headset auto detect set the appropriate switch to OFF (towards the rear of the panel).

Note: To see details of dip switches J38 and J49 please see [Appendix: IrisX panel dip switches and D25 pinouts on page 219](#)

5.7.3 Panel microphone gain

The preamplifier gain of the panel microphone can be adjusted over a range of +20 to +70 dB; the panel microphone gain's default setting is 50 dB. However, if two panels are talking to each other at the same time with the panel microphone gain set to maximum, feedback may occur even if the speaker dim is set to maximum in EHX.

In this case, it will be necessary to turn the panel microphone gain down. Similarly, in some noisy environments it may be necessary to turn the panel microphone gain down and have the operator talk more closely into the microphone.

For information on adjusting panel microphone gain, see your EHX documentation.

5.7.4 Speaker dim

When a panel microphone and a speaker are used together, feedback is possible.

To reduce this possibility, the panel software will dim (turn down) the speaker level by some predetermined amount when both the microphone and speaker are enabled. The speaker dim can be adjusted from 0 to 15 dB (its default setting is 6 dB).

For information on adjusting speaker dim settings, see your EHX documentation.

5.7.5 Page Override

When Page Override is assigned to a label, the audio level at the destination panel(s) is predetermined.

This function enables you to talk to someone even if their panel volume control is off (if the destination speaker was off, it will turn on).

The panel speaker output will operate at the predetermined level regardless of the volume control setting, unless this control is set higher than the predetermined level.

The page volume level can be adjusted from 0 to 10 in steps of 1 with 0 being off and 10 being full volume. The page volume level's default setting is 5.

For information about enabling Page Override, see your EHX documentation.

6 Using the Front Panel Controls

This chapter describes the functionality of the V-Series front panel controls in detail, including the small functional differences between lever key panels, pushbutton panels and rotary control panels.

For a brief description of all the V-Series panels covered by this guide, including product numbers, see [IrisX panels covered by this guide on page 9](#)

6.1 Key display window

The key display window is located next to the selection pushbutton, lever key or rotary control.

You can access assigned labels either by pushing the selection control (pushbutton and rotary panels) or toggling (lever key panels). Each key display window can be assigned as many as nine labels, one each from the main page and the eight shift pages. A label may either:

- Represent a talk or listen path to a panel, interface card or module, Fixed Group, or partyline.
- Activate a programmable control function.

The key display window can display up to ten Latin or Katakana characters, or five Kanji characters, together with status indicators for the key. These status indicators are:

- Currently selected page.
- Latched talk indicator.
- Latched listen indicator.
- Panel monitoring indicator.
- Microphone indicator.
- Incoming VOX indicator.
- Antenna active indicator.
- Destination type indicator (for example, a partyline, IFB, or Fixed Group).
- Remote panel connection.

6.1.1 Navigating the key display window

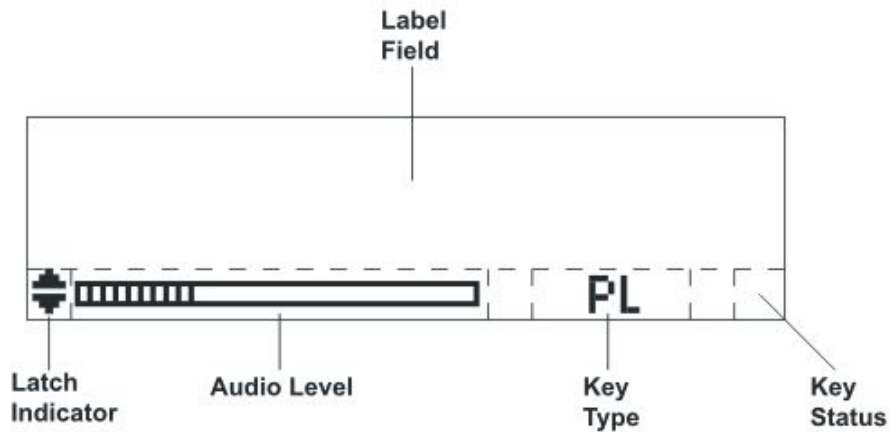

Feature	Description / comments
Label Field	10 character field for the key label.
Latch Indicator	Indicates the talk/listen status of the key. A down arrow indicates that the key is a latched talk key, an up arrow indicates a latched listen key. Both arrows together indicate a latched talk and listen key. If no arrows are displayed the key is not latched.
Audio Level	A bar graph indicating the audio level set on that route.
Key Type	Indicates the type of route or action the panel key is connected to: <ul style="list-style-type: none"> • PL = Party Line • IFB = Interruptible Foldback • FG = Fixed Group (includes stacked keys)
Key Status	Displays an icon indicating the status of this key.

-  — Incoming VOX
-  — Antenna (2 Way Radio)
-  — Telephone
-  — Remote Panel Connected
-  — Ctrl Relay
-  — Speed Dial

6.1.2 Key display window controls

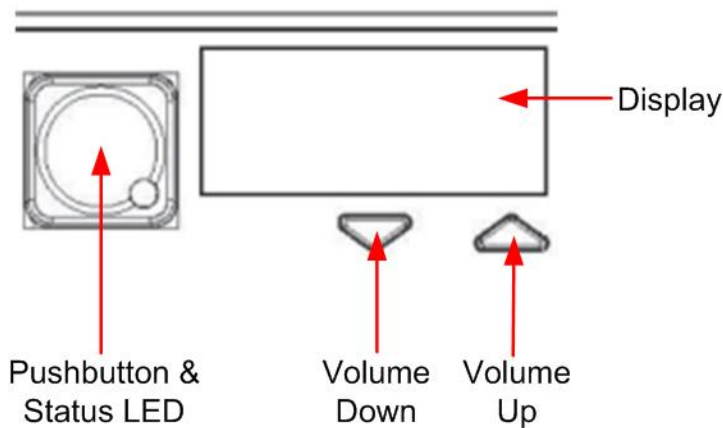
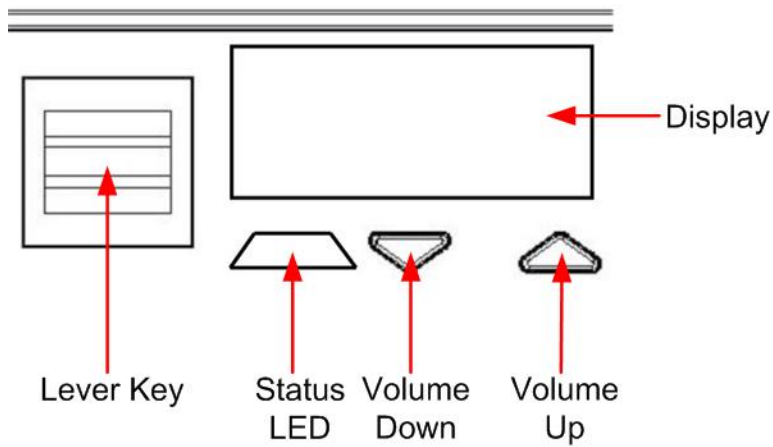

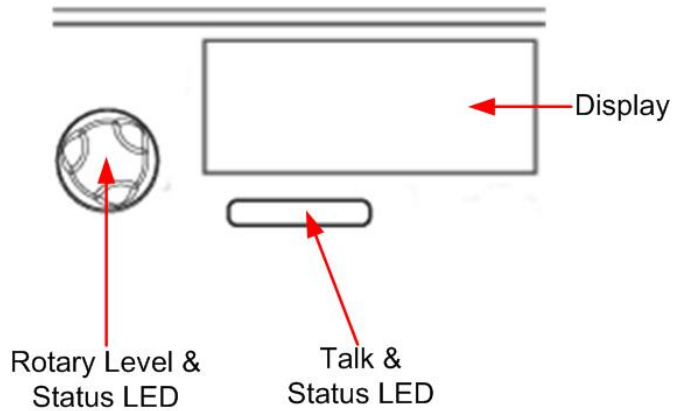

6.1.3 Navigating the Reply key display window

By default, the Reply key is placed in the lower left corner of the panel. You can move this to any other position from panel programming in the EHX software.

Note: *From the EHX Software, you can enable dual Reply keys. The second Reply key appears by default directly to the right of the first Reply key. If this position is already in use, you can either overwrite it or select another position on the panel. For more information, see the EHX Software User Guide.*

Note: *You can only reply to the last two calls. Calls are not stacked when using Dual reply keys.*

The following points apply to dual Reply keys:

- If neither Reply key has incoming calls, the first Reply key is always populated first.
- If both Reply keys have incoming calls, another incoming call replaces the older of the two original incoming calls.
- If a Reply is latched, it will not be replaced by another incoming call.
- If both Reply keys are latched, further incoming calls will be heard but will not appear on the Reply keys.

Only available on V-Series panels.

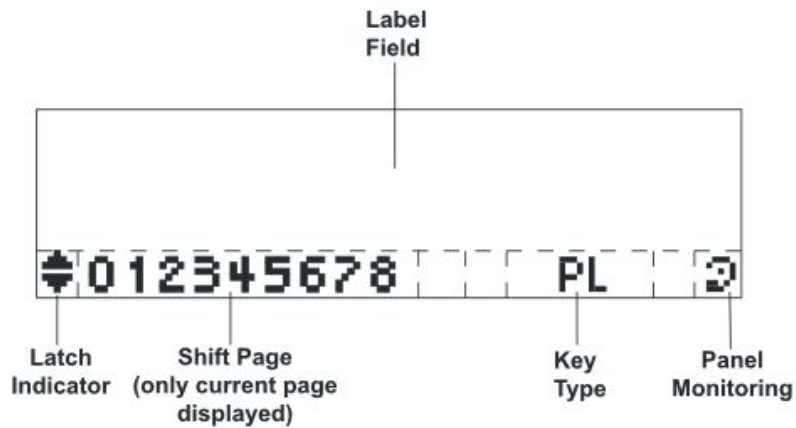

Feature	Description / comments
Label Field	10 character field for the Reply / caller label.
Latch Indicator	Indicates the latch status of the key. As the Reply key is non-latching these indicators are not displayed.
Shift Page	The number of the current shift page. Only the current page number is displayed, with the digit in the position shown in the illustration.
Key Type	Indicates the type of route or action the Reply key is connected to. When replying to an incoming call from a partyline, Fixed Group or IFB the caller port is displayed rather than the partyline, Fixed Group or IFB. The reply key only connects to the caller.
Panel Monitoring	Displays an ear icon if the panel is being monitored.

6.2 Mic On

The Mic On/Off button turns the currently selected microphone (gooseneck microphone or headset microphone) on or off.

When the microphone is On, the red LED will come on to indicate that the microphone is active. If a panel key is used to establish a talk connection the panel microphone is automatically enabled and the indicator light is lit.

When the connection is terminated the microphone is automatically disabled.

6.3 Shift Page

By momentarily pressing and releasing the Shift Page button, you can toggle between the main page and the currently selected shift page.

When you press and hold the Shift Page button for more than 500ms, the panel is placed in Shift Page mode. The Shift Page menu is shown on the display and the red indicator LED is lit.

From the EHX Software, you can also enable the shift button to cycle through consecutive shift pages.

The software now supports named shift pages. This allows the user to give any shift page a 1 - 10 character name to better identify the use of the page. See EHX user guide for information on the naming of shift pages.

From the EHX Software, you can select two shift page options:

- Selectable Shift Page
- Cyclic Shift Pages

To find these options in the EHX Software, navigate to:

Configuration > Preferences > Panel & Key Operation

The V-Series Specific Settings area is located at the bottom of the Panel & Key Operation window.

When using supervisor mode, the supervising panel will show the local shift page names when in the Shift menu.

If you latch any key on a shift page, it remains latched if you select a different shift page.

Shift Page Mode: when the Shift Page Menu is open, the keys on the panel will be color coded.

- Bright green: Shift Page currently selected
- Dim green: keys are configured on the Shift Page

6.3.1 Selectable Shift Pages

If this option is enabled in EHX software, the shift button behaves as follows:

- From the Main page (page 0), a short press or tap displays the last selected shift page. If no shift page has previously been selected, the panel displays shift page 1. The Shift LED is lit.
- To return to the Main page, short press or tap the shift button. The Shift LED is off. Pressing and releasing the shift page button toggles between the Main page and the last selected shift page.
- From the Main page, a long press (more than 500 ms) displays a list of shift pages on the panel display, with an underline on the last selected shift page. Use the panel button, switch or lever to select any shift page. The Shift LED is lit.
- To return to the Main page, short press or tap the shift page. The Shift LED is off.

6.3.2 Cyclic Shift Pages

If this option is enabled in EHX Software, the shift button behaves as follows:

- From the Main page, a short press or tap displays the next consecutive shift page in ascending numerical order.
For example, if you have a main page with five shift pages numbered as follows: M, 1, 2, 3, 5, then a short press or tap on the shift button will cycle through the shift pages as follows:
M, 1, 2, 3, M, 1, 2, 3 and so on.
Only consecutive pages are cycled, so 5 is not cycled, but can still be accessed using the shift menu.

Note: *The Shift LED is lit on any page other than the Main page.*

Note: *If shift pages have Local Assignment enabled, a shift page can cycle even if no keys are assigned to it. For more information, see the EHX Software User Guide.*

- From the Main page, a long press (more than 500 ms) displays a list of shift pages on the panel display. Use the panel button, switch or lever to select any shift page. The Shift LED is lit.
- After selecting a page, short press or tap the shift button to cycle consecutive pages or long press to return to the list of shift pages.

6.4 Headset Select

The Headset Select button enables you to select the panel headset for audio output.

When you have selected a headset, the red LED indicator is lit. The panel gooseneck microphone is deselected, if active, and the panel Headset/Microphone is activated.

6.5 Menu

V-Series panel functions are configured in Menu mode. You enter Menu mode by pressing and releasing the Menu button.

When the panel enters Menu mode, the display windows are cleared of labels and the panel menus are displayed. The blue menu LED is lit.

To exit an active menu, press the Menu button again.

Access to some panel menus can be disabled in EHX (Eclipse HX configuration software) through Advanced Settings > Menu Options in Cards and Ports. A PIN code (set in the configuration software) must be entered to disable access to these menus. When the PIN code is entered on the panel, access is granted. For more information, see your EHX documentation.

6.6 LS Main levels (volume) control

The main levels (volume) control comprises a rotary encoder with push-switch action and a tri-color loudspeaker volume indicator LED.

The LED volume indications are:

- Red - high volume.
- Amber - intermediate volume.
- Green - low volume.

Turn the volume control clockwise to increase the loudspeaker volume and anticlockwise to decrease loudspeaker volume.

The loudspeaker cut indicator LED is lit red when the loudspeaker output is muted. Press the volume control to toggle the loudspeaker cut.

6.7 Auxiliary levels (volume) control

The auxiliary panel levels (volume) control comprises a rotary encoder with push-switch action and a tri-color loudspeaker volume indicator LED. The LED volume indications are:

- Red - high volume.
- Amber - intermediate volume.
- Green - low volume.

The auxiliary levels (volume) control sets the volume on the optional external loudspeaker that you can connect to the auxiliary audio port on the rear of the panel. Turn the volume control clockwise to increase the loudspeaker volume and anticlockwise to decrease loudspeaker volume.

Press and release the auxiliary volume control to play back messages stored on the Listen Again system (see next section).

6.8 Listen Again

The Listen Again feature is configured in EHX. For more information, see your EHX documentation.

Pressing the auxiliary volume control switch momentarily activates the Listen Again feature. The last stored audio will be replayed (this feature is configured in EHX).

Repeatedly pressing the auxiliary volume control will step back through the stored messages.

- The total message storage available is 300 seconds.
- The total number of separate messages is 120.

6.9 Up / Down buttons on lever key and pushbutton panels

There is a pair of small blue buttons to adjust the volume level on the connection beneath each key display window on lever key and pushbutton panels.

Use the left (Down) button to reduce the volume and the right (Up) button to increase the volume.

You can also use the volume buttons to release a telephone line, in the same way as the TEL RELEASE function in the diagnostic menu.

To release the telephone line, press both of the Up and Down buttons together.

The label display changes to TEL RELEAS, and the telephone is put back on the hook. All latched keys on the local system are unlatched, killing all routes to the telephone. After approximately 5 seconds, the display starts displaying the configured label again.

If the panel does not have Line Release configured, then the call signal is sent to the label instead.

Note: *The volume buttons are also used to adjust some settings that are accessed through the panel menu, such as Sidetone Gain.*

6.10 Alternative text key

In the EHX software, you can define alternate text for display on a panel. You can then assign an Alt Text key on the panel.

When selected it will turn red. If alternate text is available for that label the panel will show this.

Alias names, third-party alias names and Dynam-EC text labels will override whichever state the panel is in.

One possible use of alternate text is to set up a dual language configuration on the panel, for example to allow panels to display Arabic by default in a particular Middle Eastern broadcast installation. English speakers could then select the Alt Text key on a panel to see the English equivalents to the Arabic labels.

Another use could be that both the role name and user name could be configured for each panel or beltback port. This would allow panel users to see either the name or the role depending on the Alt Text mode selected.

You can enter alternate text on all the entity screens. The column with the text can be shown or hidden from EHX using the button in the Port List options.

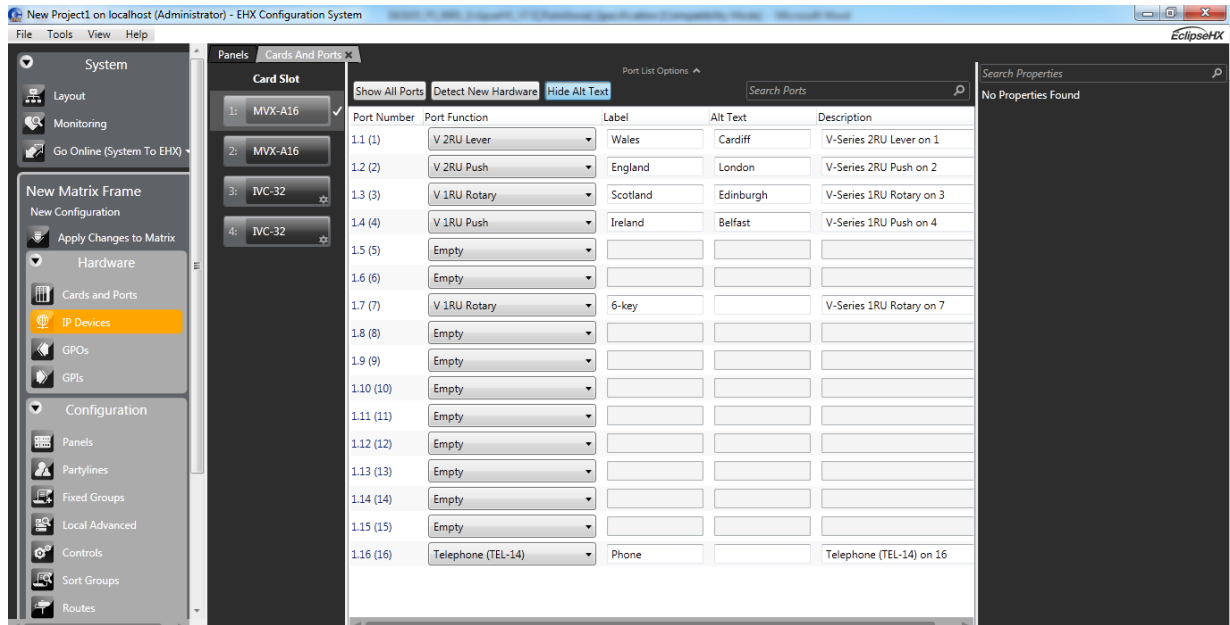

6.11 Rotary control on rotary panels

The rotary control located next to the key window display on rotary panels is used to adjust the volume on the connection. Turn the rotary control clockwise to increase the volume and anticlockwise to decrease the volume.

Holding the talk key and turning the rotary adjusts the IFB send level.

You can also use the rotary control to release a telephone line, in the same way as the TEL RELEASE function in the diagnostic menu.

To release the telephone line, press and hold the rotary control.

The label display changes to TEL RELEAS, and the telephone is put back on the hook. All latched keys on the local system are unlatched, killing all routes to the telephone. After approximately 5 seconds, the display starts displaying the configured label again.

If the panel does not have Line Release configured, then the call signal is sent to the label instead.

Note: *The rotary control is also used to adjust some settings that are accessed through the panel menu, such as Sidetone Gain, and scrolling through lists.*

6.12 Dial pad (2RU panels)

Use the dial pad on 2RU panels to:

- Access some menu pages directly (as a shortcut).

- Enter dialcodes, to dial out through a telephone interface, such as the TEL-14 interface module.

The menu shortcuts available from the dial pad are as follows:

Dial pad key	Menu shortcuts
1	Dial menu
2	Local Exclusive
3	Local page override
4	Assignment Panel menu
5	Local Key Assign menu
7	Local Preferences menu
8	Fast Key Assign menu
9	Diagnostics menu

When the dial pad keys are used to access a menu function, the blue menu LED is lit.

6.13 Push-To-Talk (PTT) operation

Push-To-Talk (PTT) operation on V-Series panels is performed using a PTT switch on either:

- The panel headset.
- The auxiliary audio connector on the rear of the panel.

The operation of PTT on the V-series panels is configured in Logic Input Options EHX. You can set the Headset PTT Function to one of three options:

Option	Description / comments
No Function	The headset PTT does not activate any talk or listen routes.
Activate All Talk Keys	The headset PTT activates the audio routes for all latched talk keys. Unlatched talk and listen keys are not activated.
Activate Two-Way Radio Talk Keys	The headset PTT activates the audio routes on all latched talk keys attached to two-way radios. Unlatched talk keys and listen keys are not activated.

6.14 Status LEDs (Tallies)

Status LEDs (tallies) indicate the status of a key, audio route, or menu option.

In the case of lever key panels, the status LEDs are set under the display windows. In pushbutton panels, the push buttons themselves act as status indicators, and there are no separate LEDs. In rotary panels, the rotary controls and the talk buttons act as status indicators.

The status LEDs (tallies) signal the following:

LED action/state	Description / comments
Solid red	A talk path (audio route) is active.
Solid green	A listen path (audio route) is active.
Solid amber	A talk and listen path (audio route) is active.
LED is off	Key is either not configured or the menu option is not selectable.
LED flashing	Either user action is required, or there is an incoming call or call signal.
LED is dim red	Key is configured as a talk key or a menu option is selectable.
LED is dim green	Key is configured as a listen key or menu option is selectable
LED is dim amber	Key is configured as a talk and listen key or menu option is selectable.
LED is blue	Menu mode is active.

Specific information on the operation / action of status LEDs (tallies) is provided by sections describing specific functionality and / or menu operations.

6.15 Communication errors

If the panel loses data communication with the matrix, the following message is displayed:

`Waiting for Eclipse`

When data communication is restored, the panel automatically returns to normal operation.

6.16 Lever key panels

Lever keys can:

- Have both talk and listen labels assigned to the same key in EHX.
- Be used as either talk or listen keys, depending on whether the key is moved up or down. If the key is moved upwards then the listen function is selected while if the key is moved down then the talk function is selected.

The lever keys normally default to latching unless the non-latching option is configured in EHX under Global Settings (Latch Disable set to True) for the destination port. In the default state (latching), pressing the lever key momentarily up or down latches the key.

If you hold the lever key in the talk or listen position for more than 200ms, the lever key does not latch and the connection terminates as soon as the key is released.

When the key is inactive, the talk/listen status indicator below the key is lit amber. When a talk path is active (key pressed down) the status light is lit red, and when a listen path is active (key pressed up) the status light is lit green.

An incoming call to the panel will cause the Reply key indicator to flash red. To take the call, press the reply key down. To clear the call press the Reply key up.

6.16.1 Reply key general purpose input (GPI) functionality on lever key panels

If you connect a footswitch (or other type of switch) to GPI 3, which is pre-assigned to the Reply key, the panel clears the item that is currently being viewed on the reply stack when you release the switch.

You can use the Reply key up/down to scroll through the Reply key stack if more than one call is present on the answerback stack. To move to the next call, press the up button. To return to the previous call, press the down button.

For more information, see [Opto-Isolated Inputs] and your EHX documentation.

6.16.2 VI-PNLB-32L function keys

The VI-PNLB-32L panel has programmable function keys.

Use the default settings or change the key operation settings in the EHX configuration software.

Function key	Default settings
F1	Scrolling assign: scroll through Sort Groups and choose which member of the group to communicate with.
F2	Alt text: toggle between text labels and alternative text labels. For example; toggle between English and French, or role name (lighting) and person name (John).
F3	Message menu: access the menu that allows you to control message function options.
F4	Reset crosspoint gain. Reset volume adjustments on all audio sources coming into the panel to 0dB.

VI-PNLB-32L function key options

VI-PNLB-32L function keys can be set in the EHX configuration software to perform the following tasks:

Option	Description	Function key LED behavior
Activate all pre-selected Talk keys.	When this option is selected, no configured audio routes are activated for latched keys until the associated function key is pressed (and held).	LED is on while the key is pressed.
Activate all pre-selected two-way radio Talk keys.	When this option is selected, no configured audio routes to two-way radios are activated until the associated function key is pressed (and held).	LED is on while the key is pressed.
Activate configured action	This option allows the user to allocate a control sequence or macro to a function key. Use the EHX configuration software to generate control sequence. See the Eclipse EHX Software User Guide.	LED is on while the key is activating the control sequence. Note: this is not the same as indicating when the control is active, if the control is activated via another means then the LED will not be lit.
Reset panel crosspoint gains to 0dB.	Opens the Reset Xpts (Yes/No) dialogue box. Selecting Yes resets the volume adjustment on all incoming audio sources to 0dB.	LED is on while the Reset Xpts menu is open.
Alternate text	Enables/disables the Alt Text mode on the panel. Pressing this key will cause the key displays to show alternative text. Press the key again to return to standard text.	LED is on while the Alt Text mode is enabled.

Option	Description	Function key LED behavior
Scrolling assignment	When this option is selected, pressing the function key will result in all keys programmed with Sort Groups flashing. You can then use the up and down keys on the Keypad controls to scroll through group members. When a group member is visible in the key display, Talk and Listen to that member.	LED is on while Scrolling Assignment mode is enabled. Pressing the function key again will exit from scrolling assignment mode. This mode has a 10 second timeout.
Supervisor	When this option is allocated to a function key, pressing the key will enable the first stage of Supervisor mode. See Supervise mode in the Eclipse V-Series User Guide.	LED is on while Supervise mode is enabled. To exit Supervise mode, press and hold the Menu key. Please note that the method of exiting Supervise mode is not the same as for other function keys.
Message menu	Access the menu that allows you to control message function options.	LED is on while the Message menu is open.

6.16.3 Change function key options on a VI-PNLB-32L panel

Use the EHX configuration software to change function key settings on a VI-PNLB-32LD panel.

Open EHX and navigate to Cards and Ports.

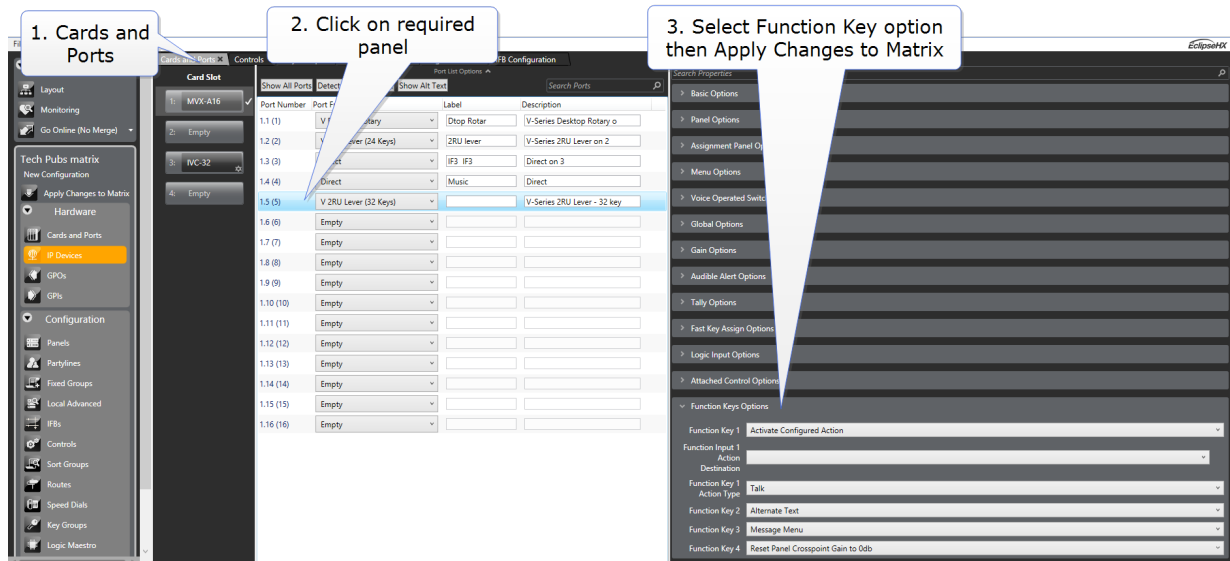

6.16.4 Using a Scrolling Assignment function rotary key on a Lever Key panel

The Scrolling Assign feature allows you to scroll through members of a Sort Group in order to access individual group members quickly and assign them to the intercom key. The assigned scroll group member can then be keyed as normal.

This is the default option on Function Key 1 for a V32L panel.

To use Scrolling Assign, Sort Groups must be already created and assigned to a panel key. This is done in the EHX configuration software. See Eclipse EHX Configuration Software User Guide for more information.

For V12 and V24 Lever Key panels, assign the Scroll Assign Key to one of the intercom keys.

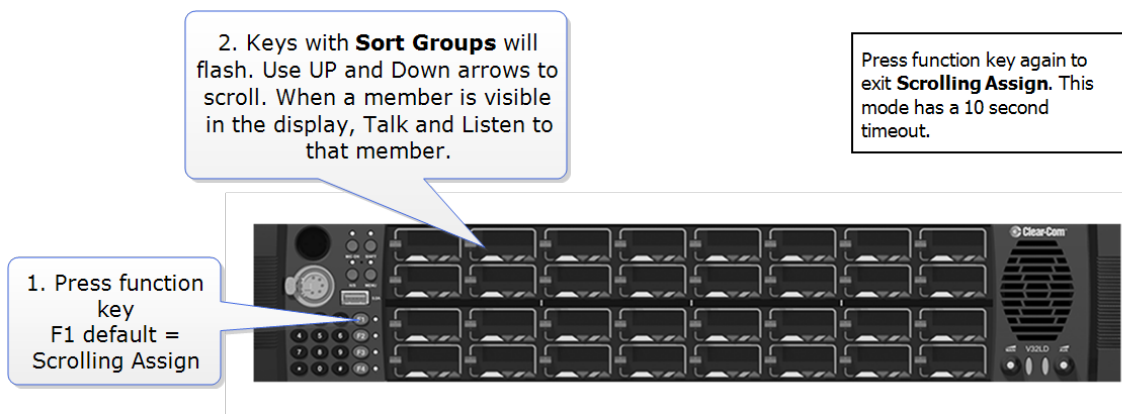

When in Scrolling Assign mode, pressing the Assign lever key will have the same effect as pressing the function key again; you will exit the mode and return to normal operation.

6.17 Pushbutton panels

Pushbuttons are either talk or listen keys, according to how they have been assigned in EHX.

Pushbuttons normally default to latching unless the non-latching option is configured in EHX under Global Settings (Latch Disable set to True) for the destination port. In the default state (latching), pressing the button momentarily latches the key.

If you hold the pushbutton for more than 200ms, the lever key does not latch and the connection terminates as soon as the key is released.

When the pushbutton is inactive, the pushbutton is lit either dim red, green or amber (depending on whether it is configured as a talk (red), listen (green) key, or talk and listen (amber) key).

When the pushbutton is active, the pushbutton is lit either bright red, green, or amber, according to how it is assigned.

To cancel a connection, press the pushbutton. The button returns to dim illumination.

An incoming call is signaled by a flashing red Reply pushbutton. To pick up the call, press the Reply pushbutton.

6.17.1 Pushbutton Reply key GPI operation

Connecting a footswitch (or other type of switch) to GPI 3, which is pre-assigned to the Reply key, the panel will not clear the item that is currently being viewed on the reply stack when you release the switch.

You can use the Reply key up/down to scroll through the Reply key stack if more than one call is present on the answerback stack. To move to the next call, press the up button. To return to the previous call, press the down button.

For more details, see 7.2.13 [Opto-isolated inputs on page 26](#) and your EHX documentation.

Note: *For an audio block diagram for V-Series panels, see [Rotary panel Reply key on page 75](#). The diagram shows all the allowed audio routes and valid crosspoints allowed by V-Series panels. Some of the audio paths shown by the diagram are only available with the audio mixer function in EHX.*

6.18 Rotary panels

Rotary panels can have talk and listen labels assigned to the same key in EHX. The talk and listen functions are divided between the rotary control (listen) and the pushbutton under the display (talk).

If the rotary control is pressed then the listen function is selected. The rotary control light is lit green.

If the pushbutton (talk button) under the display is pressed, then the talk function is selected and the talk button is lit red.

If listen is latched while talking, then the rotary control is lit green and the pushbutton (talk button) is lit red.

6.18.1 Using rotary panel keys

By default, the talk label is displayed on a key, unless a listen only label is configured for the key.

For all panel types in assignment panel mode, the talk labels are shown on possible IFB destinations and the listen labels are shown when the user is selecting an IFB source.

The rotary control and talk button normally default to latching unless the non-latching option is configured in EHX under Global Settings (Latch Disable set to True) for the destination port.

In the default state (latching), pressing the rotary control or talk button momentarily latches the key.

If you hold the rotary control or talk button for more than 200ms, the key does not latch and the connection terminates as soon as the key is released.

When the rotary control is inactive, the center of the control is lit dim green. When the talk button is inactive, the button is lit dim red.

If the brightness control is turned down further, the dimmed lighting of the rotary control and talk button is turned off entirely.

When you press the rotary control to establish a listen route, the center of the control is lit bright green. When you press a talk button to establish a talk route, the button is lit bright red.

To cancel the connection press the rotary control or talk button.

An incoming call is signaled by a flashing red Reply key talk button. To pick up the call press the reply key talk button.

6.18.2 Rotary panel Reply key

The Reply key on a rotary panel can be overwritten with other talk and listen labels in EHX without being deleted. This enables the creation of:

- 12 listen and 12 talk pairs for each 1RU panel.
- 24 listen and 24 talk pairs for each 2RU panel.

If you enter Menu mode and the reply key has been overwritten / is no longer available, the Assignment Panel (AP) functions are disabled. If the labels placed on the Reply key are removed in EHX, the Reply key becomes available again and Assignment Panel functions are restored.

You can use the Reply key rotary control to scroll through the Reply key stack if more than one call is present on the answer back stack. To move to the next call, turn the rotary control clockwise. To return to the previous call, turn the rotary control anticlockwise.

6.18.3 Assignment Panel (AP) mode and the INTERCOM key

Assignment Panel (AP) mode is enabled in EHX. AP mode enables you to add members to local partylines (conferences), local Fixed Groups, and route local audio sources to IFBs.

Note: *IFBs can be added to Fixed Groups in AP mode.*

There are three ways to access AP mode on rotary panels:

- Press Menu and then select ASSNMT PNL.
- Press the dial pad 4 key (a shortcut to the ASSNMT PNL menu).
- Press an assigned INTERCOM button.

You can assign a special INTERCOM button to any key on a rotary panel including the Reply key in EHX. The position of the INTERCOM key on the panel determines which buttons are available for making assignments and which remain in intercom mode. This feature extends to expansion panels, enabling you to perform intercom and assignment operations simultaneously.

When the INTERCOM key is selected, the panel enters Assignment Panel (AP) mode without entering Menu mode. If you select an INTERCOM key that has been placed on an expansion panel, then the expansion panel (and any other expansion panels in the daisy chain) is placed in AP mode and can be used normally.

You use the INTERCOM key in exactly the same way as the Reply key in Menu mode when making assignments.

For detailed information about making assignments, and the appearance of the panel displays, see [ASSNMT PNL \(Assignment Panel\) menu on page 158](#)

For more information about using the dial pad to perform tasks, see [Dial pad \(2RU panels\) on page 66](#)

Note: *If the Reply key has not been reassigned in EHX, the talk button on the Reply key will also flash when in AP mode, mimicking the INTERCOM key status.*

6.18.4 Rotary panel interruptible foldback (IFB) operation

When a rotary panel key is assigned to an IFB, you can use the rotary control to adjust the audio level sent from the panel to the IFB destination or the IFB return listen level at the panel.

If you latch the call to the IFB destination by momentarily pressing the talk button, you can adjust the level of the audio sent to the IFB destination by turning the rotary control.

If the call to the IFB destination is not latched (the talk button is held down) the audio level is adjusted by pressing and turning the rotary control.

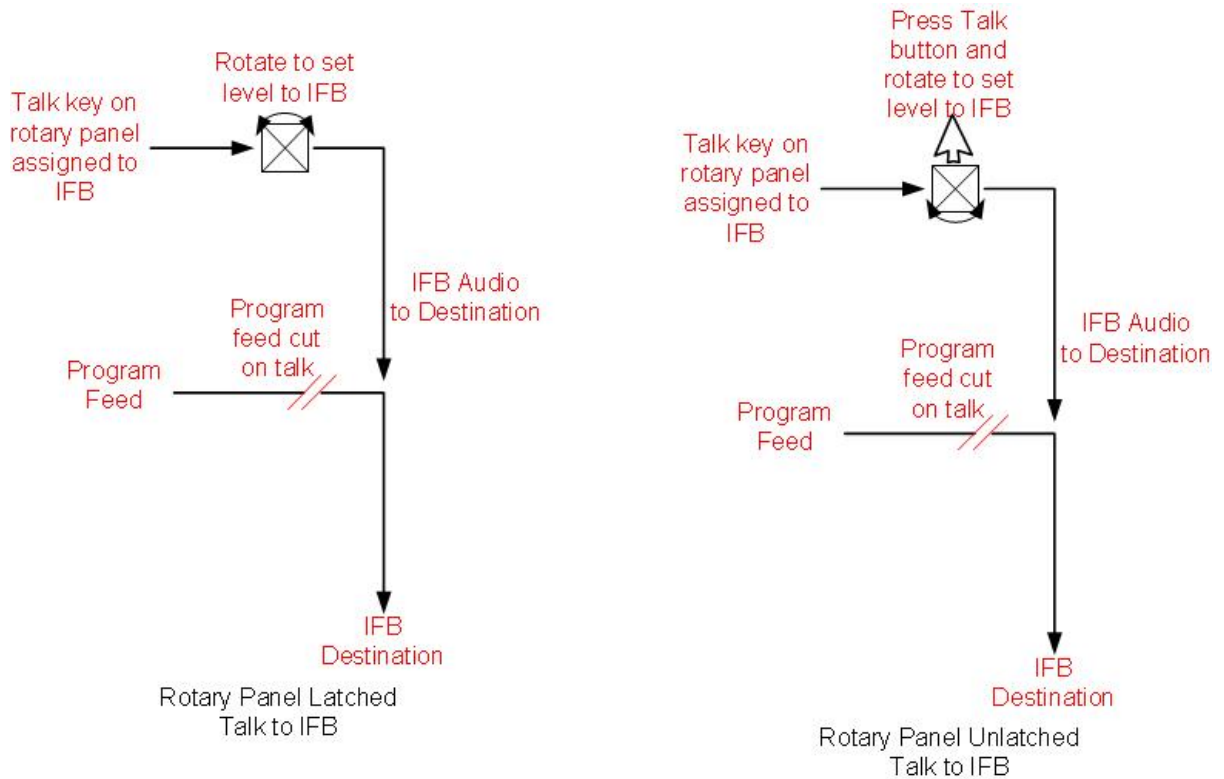

6.18.5 Rotary panel Forced Listen

Forced listen key operation on rotary panels differs from lever key and pushbutton panels. A forced listen key on a rotary panel will show the rotary control lit bright green to indicate active listen.

Pressing the rotary control, when it is configured as a forced listen, will mute the audio from the forced listen. Pressing the rotary encoder again restores the forced listen audio.

6.18.6 Rotary panel Reply key GPI operation

Connecting a footswitch (or other type of switch) to GPI 3, which is pre-assigned to the Reply key, the panel will not clear the item that is currently being viewed on the reply stack when you release the switch.

For more details, see Opto-Isolated Inputs and your EHX documentation.

Note: *The audio block diagram shows all the allowed audio routes and valid crosspoints allowed by V-Series panels. Some of the audio paths shown by the diagram are only available with the audio mixer function in EHX.*

6.18.7 Audio block diagram

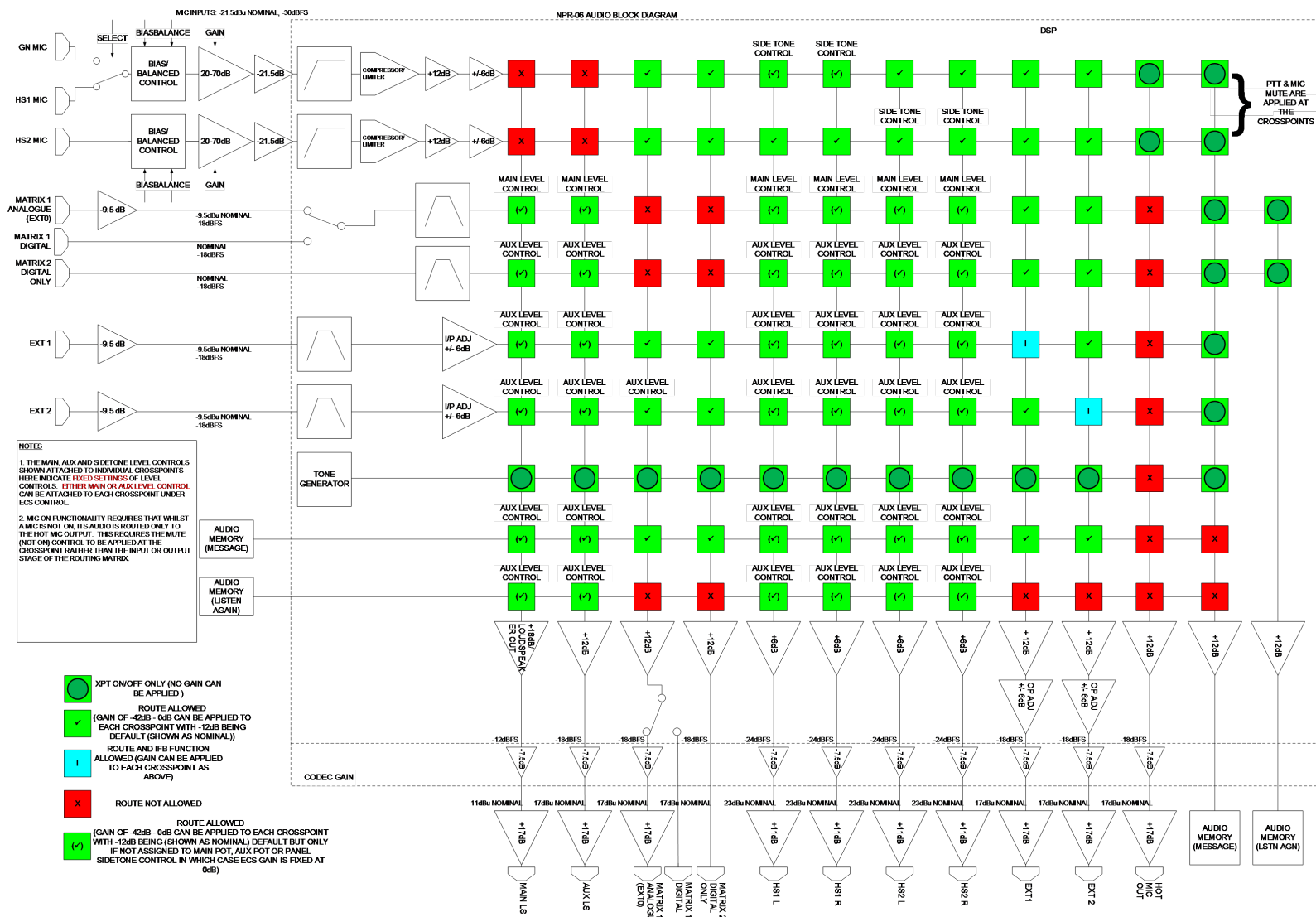

Audio block diagram

7 Connecting the IrisX panel to a matrix

The IrisX panel can be connected to a Clear-com matrix using AoIP, IVC or MVX connection methods. (See [Interconnectivity overview on page 12](#)).

This section describes how to set up the AoIP and IVC connection methods.

The IrisX panel will lock to any connection type. Therefore, if you need to change the connection type of your panel (for example, it has been previously connected via IVC and you want to connect via AoIP) you must power cycle the panel and reset it before starting the connection process. After a power cycle, the panel will be able to accept a new connection type.

7.1 AoIP interconnectivity

For an AES67 type connection (AoIP), use an E-IPA-HX interface card.

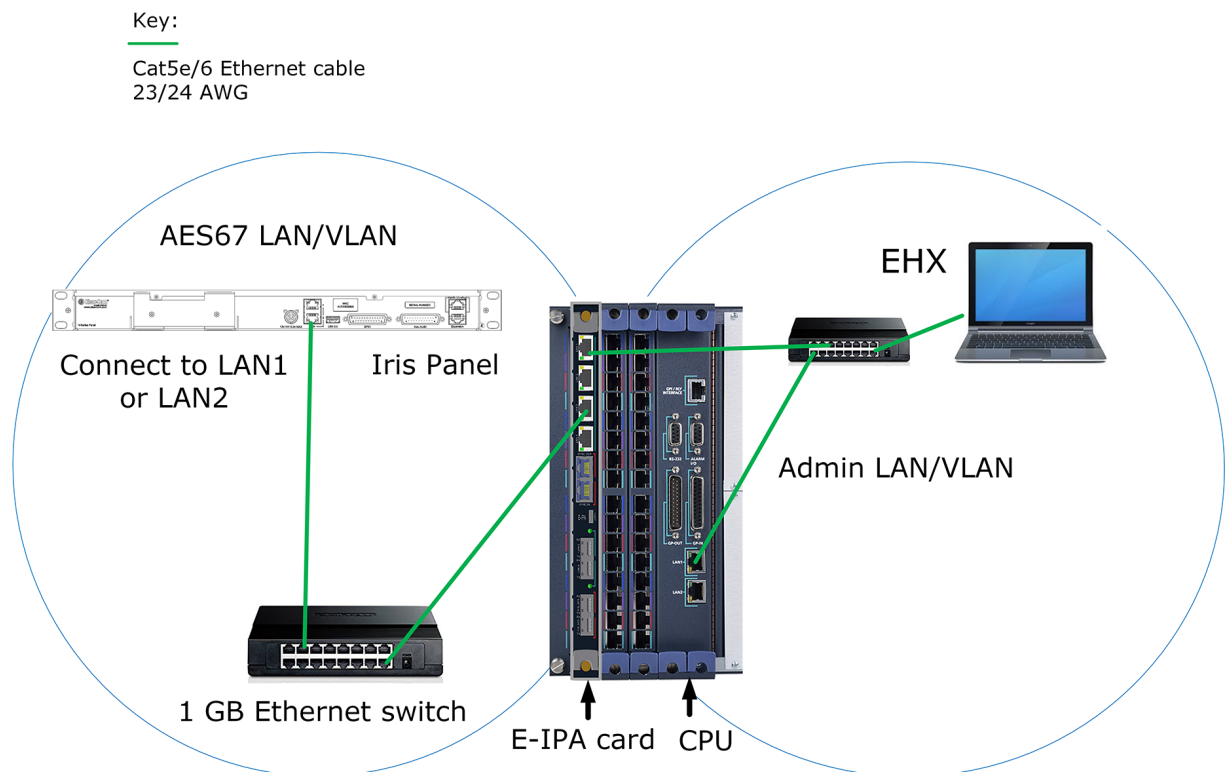

Note 1: E-IPA LAN1 = default Admin and IVC setting
 E-IPA LAN3 = default AES67 setting

Note 2: For the AES67 network, you must use at least CAT6 (AWG23/24) cable to achieve ~80m cable distance between devices

Note 3: There is only one AES67 connection on the E-IPA card. All Clear-Com AoIP devices will be connected to the same network

7.1.1 Overview

1. Cable devices as shown
2. Check the settings on the switch used for the AES67 network. For more information, see the AoIP Network Recommendations Guide on the Clear-Com website.
3. Configure the EHX software
 - Add port
 - Select panel type
 - Select connection type (AoIP) in panel properties
 - If necessary, check IP settings on the E-IPA card (navigate to **Cards and Ports > E-IPA Card Properties**). Set the E-IPA AOIP LAN port to have a static IP address.
4. Initiate the connection between the IrisX panel and the matrix
 - Use the device discovery feature or
 - Insert the mDNS name of the panel (printed on the panel rear) into EHX in panel properties
 - In both cases **Apply Map to Matrix** to start the connection process
 - Monitor the connection process in the IrisX panel screens or EHX Monitoring. Also check the Event Log as necessary.

7.1.2 Detailed steps

1. Cable your devices as shown above (example set up). Note that Admin and AES67 are on separate subnets. The default IP setup is DHCP.
2. Check the settings on the switch used for the AES67 network:
 - 1 GB minimum
 - DiffServe QoS
 - IGMP v2 + querier (1 querier per network)
 - AES67 PTP profile (for PTP aware switches)
3. Configure the EHX software.
 - a. Open the EHX software and navigate to **Hardware > Cards and Ports**
 - b. Click on the E-IPA card to select it
 - c. Add a port using the green **+ port** button

- d. Set the port function : click **Port Function**, then select the type of panel you have from the dropdown list

At this point, you have the option of adding up to two auxiliary audio channels (hosted directs)

- e. Set **Connection Type** to **AoIP** in **Port Properties> IP Port Options**

Any auxiliary audio channel (hosted direct) that has a parent port in AES67 (AoIP) mode will also be in that mode.

4. Initiate connection between the IP panel and the matrix. There are two possible connection methods: using the mDNS name of the panel (found on the device rear), or using the device discovery feature.
 - Device discovery. See [Device discovery on page 85](#)
 - mDNS connection. See [IrisX panel to matrix mDNS connection on page 81](#)

After you have applied the map to the matrix, the connection process will begin. You will see **Eclipse connection up** displayed in the panel menu display screens when a data connection is made. Wait a few minutes for the audio routes to connect and for any keys you have configured to appear on the panel keysets.

Monitor the connection process in the IrisX panel screens or EHX Monitoring. Also check the Event Log as necessary.

7.1.3 IrisX panel to matrix mDNS connection

The mDNS hostname is printed on the back of the IrisX panel in the form: CC-IRIS-XXXXXXXX, where XXXXXXXX is the serial number. Make a note of this number as it can always be used to locate the IrisX panel on your network.

Note: *It can also be found in the bottom right-hand corner of the panel main display when the panel is OFF line and not connected to the matrix.*

When using the mDNS/hostname to connect to the panel, insert this number into port properties in the EHX software and **Apply Map to Matrix** to start the connection process.

File Tools View Help

System

Tech Pubs matrix

New Configuration

Retrieve Map from Matrix

Apply Map to Matrix

Hardware

Cards and Ports

IP Panels

GPOs

GPIs

Configuration

Diagnostics

Hardware Help

Cards and Ports

IP Panels

Tech Pubs matrix\New Configuration\Cards and Ports

E-IPA-32-HX

Available Ports: 31

Ports reserved for FSII Beltpacks: 0

Hide FSII Ports

Search Ports

Options

Port Number	Port Function	Label	Description
3.1 (1)	V 1RU Rotary		V 1RU Rotary

1. Set **Connection Type** to **AoIP**

2. Input **mDNS HostName** in the form: **CC-IRIS-XXXXXXX** where XXXXXXXX is found on the back of the Iris panel; SN XXXXXXXX (case sensitive).

3. Apply Map to **Matrix**

Search Properties

Basic Options

Panel Options

Assignment Panel Options

Menu Options

Voice Operated Switch Options

Global Options

Gain Options

Audible Alert Options

Tally Options

IP Port Options

Connection Type: AoIP

mDNS HostName / IP Address: CC-IRIS-34XVF95

Audio Codec: G722

User ID: rota

Network Connection: LAN

Password

7.2 IVC connectivity

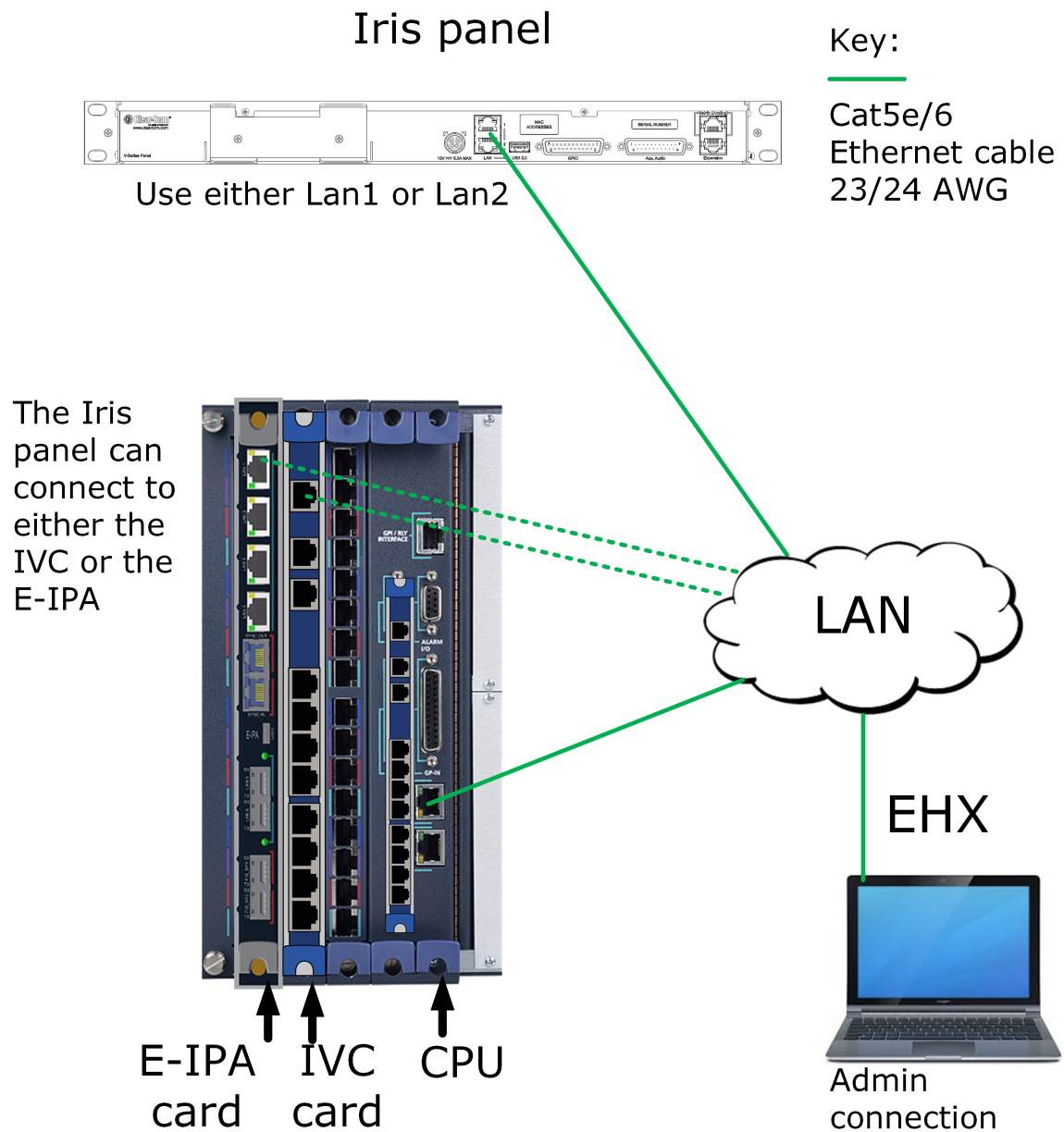

IVC connectivity

7.2.1 Overview

1. Cable devices as shown
2. Check the IP settings on your E-IPA card in the EHx software (navigate to **Cards and Ports > E-IPA Card Properties**). The default setting is to have Admin and IVC on LAN 1 (recommended). IVC IP settings must be set to Static (not DHCP).

3. Configure the EHX software
 - Select card; either E-IPA or IVC-32
 - Add port
 - Select panel type
 - Select hosted directs if required
 - Select connection method (IVC) from panel properties
4. Initiate connection between the IP panel and the matrix. There are 2 possible connection methods:
 - Using the Device Discovery feature. Device discovery will only work if the panels and matrix are on the same subnet. The Device Discovery feature will automatically populate both the panel and the EHX software with **User ID** and **Password** credentials.
 - Manually enter the User ID and Password into both the panel and the EHX software. Use this method if you are connecting remote panels. See [Accessing the IP configuration menus on page 171](#) for more information.
 - In both cases, you must **Apply Map to Matrix** to start the connection process.
 - Monitor the connection process in the IrisX panel screens or EHX Monitoring. Also check the Event Log as necessary.

7.3 Setting a static IP address

The V-Series IrisX panel uses two IP addresses when connected over AoIP. There is an Admin address and an Audio (AES67) address. When the panel is connected in IVC mode, only the Admin IP address is used. From the front panel menus, you can set either of these IP addresses as static.

To set a static IP address for Audio (AES67):

1. Press the **Menu** button, and navigate to **IP Setup > Net Setup > AES67 DHCP > AES67 > Disable > AES67 IP**
2. Enter the required static address.

To set a static IP address for Admin:

1. Press the **Menu** button, and navigate to **IP Setup > Net Setup > DHCP > DHCP > Disable > DHCP**
2. Enter the required static address.

Note: The Panel's IP ADDRESS and AES67 IP must be set on the same subnet. For example: IP Address = 192.168.12.34; AES67 IP = 192.168.12.35.

7.4 Device discovery

To use the device discovery feature navigate to **EHX>Hardware>IP panels**.

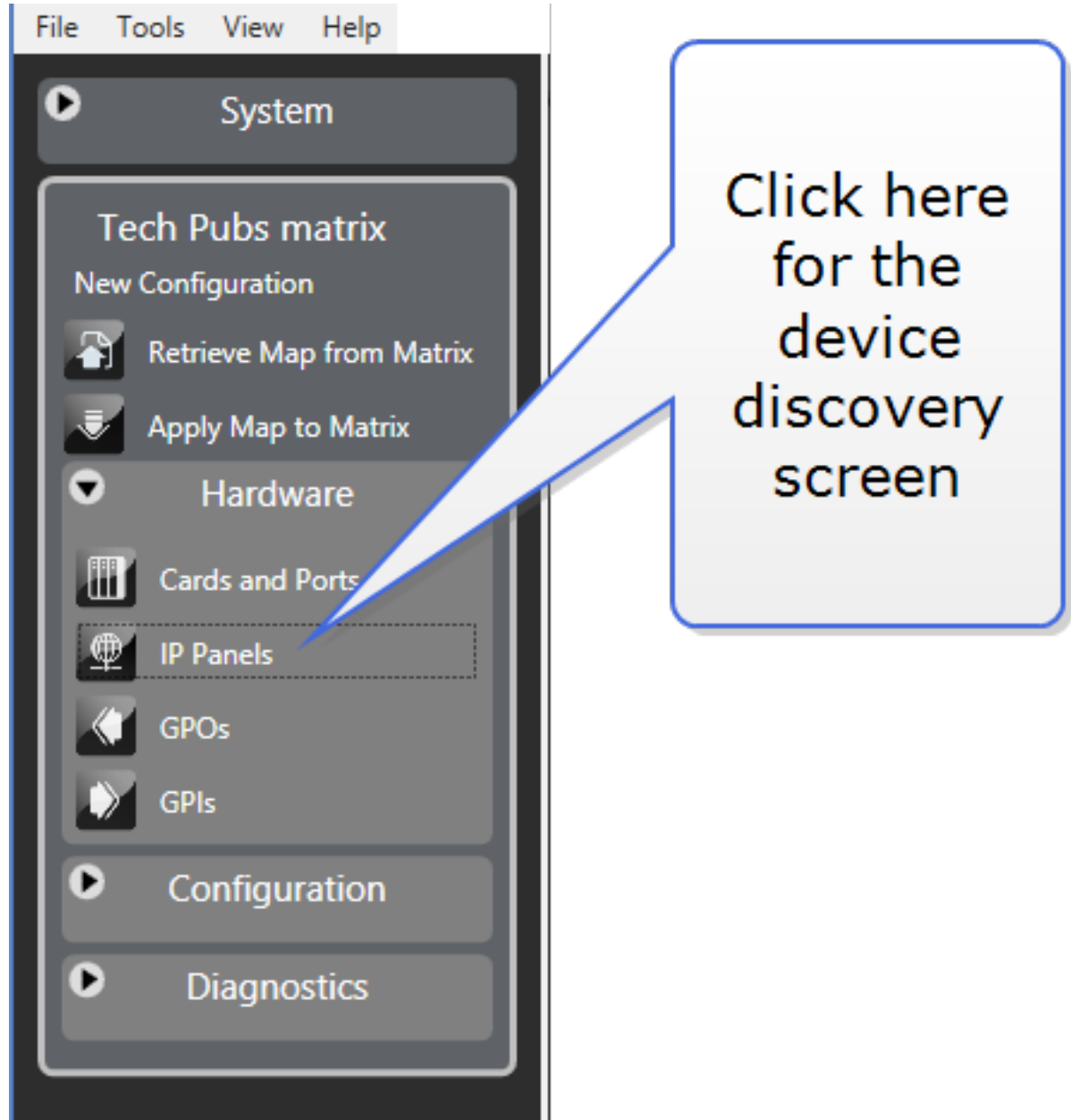

Device discovery can be used for all IP devices and IP connection types (AoIP and IVC). Use this screen in EHX to discover and automatically connect IrisX panels to a matrix.

Note: Do not use device discovery to connect remote IrisX panels. To connect IrisX panels across subnets you must input the connection credentials (User ID and Password) for the panel

manually. See [Accessing the IP configuration menus on page 171](#) and the following sections.

For device discovery to work, the devices must be in the same broadcast segment or subnet.

Network requirements for the Device Discovery feature

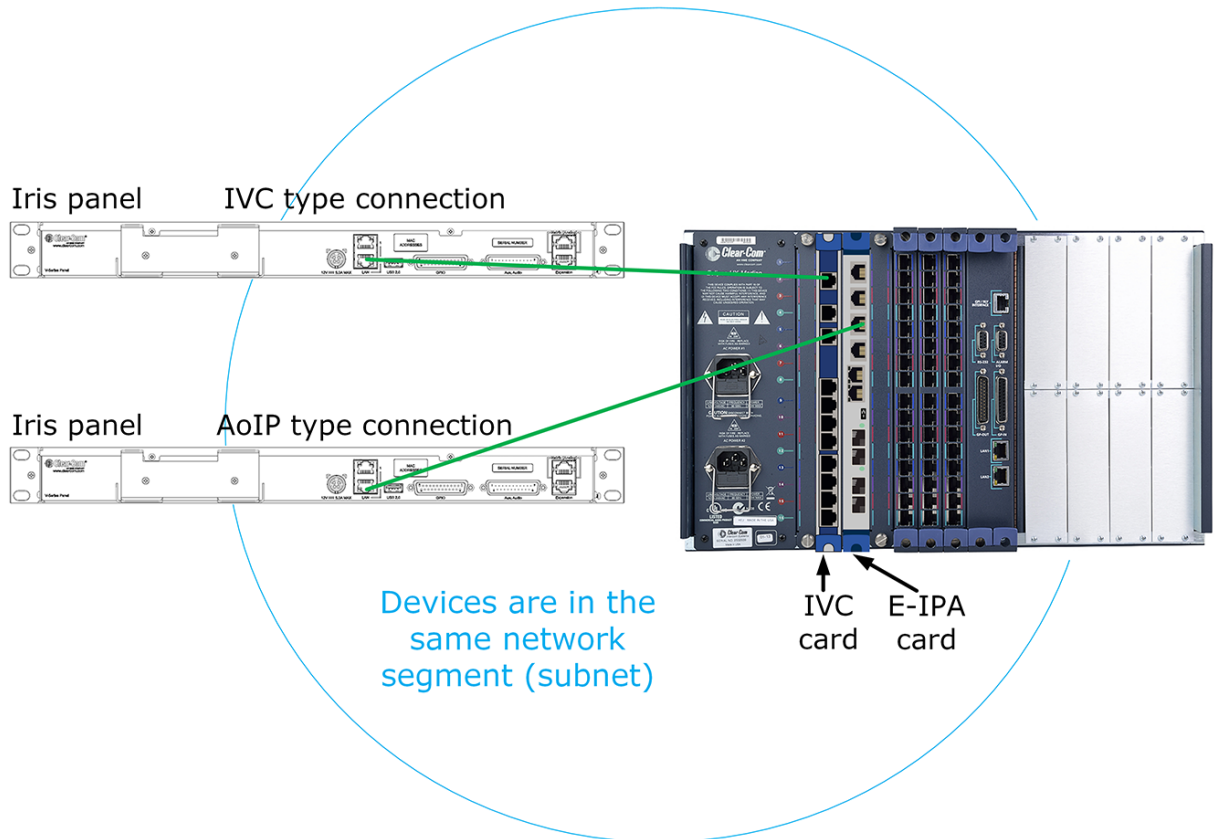

7.4.1 How to use the device discovery feature

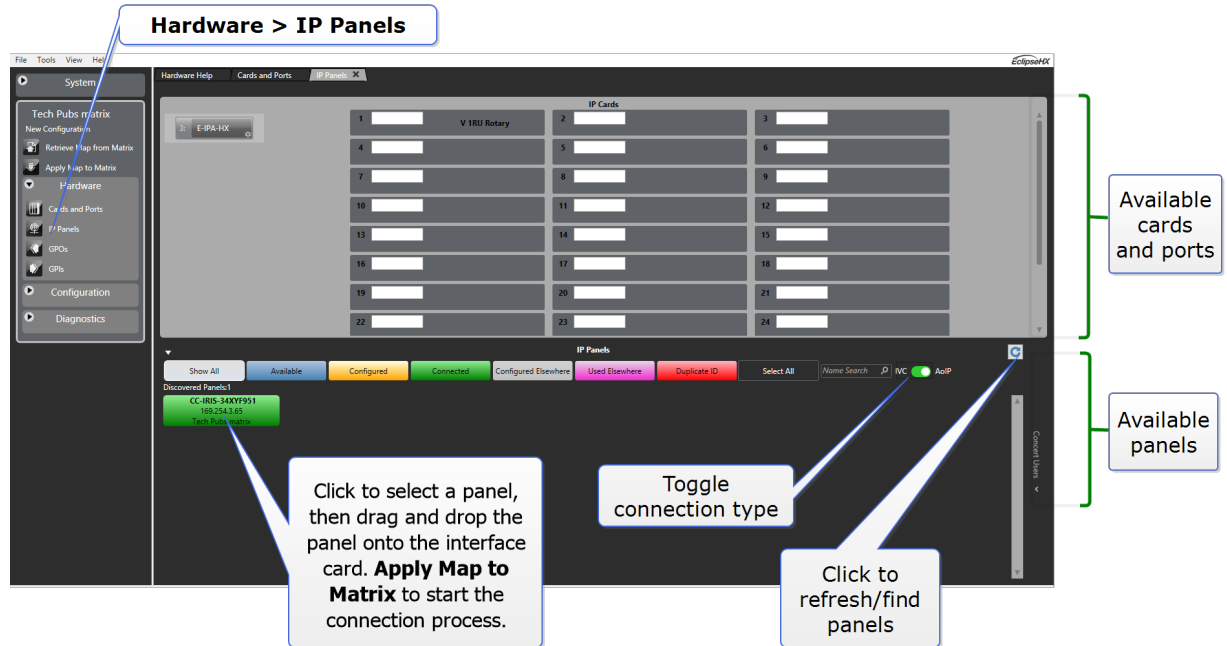

Note: You can drag and drop the panel onto either the card or a port slot.

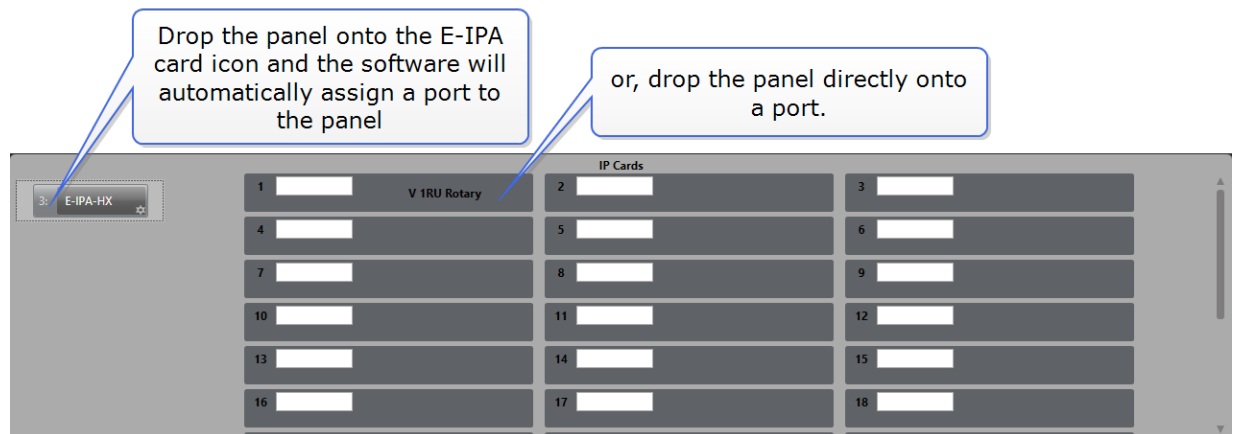

Note: If you drop a panel onto an existing panel on the card, the new panel takes the configuration of the old panel. This action will clone the configuration of the previous panel.

7.5 Network requirements

Clear-Com AoIP devices need careful setup of IP settings as the E-IPA card uses up to three IP addresses. It also requires careful setup of network switches. For details see *Clear-Com AES67/AoIP Network Recommendations*.

Note: Disable PoE (Power over Ethernet) on switch ports connected to IrisX LAN connectors to avoid rare down/up events which affect the functionality of the panel.

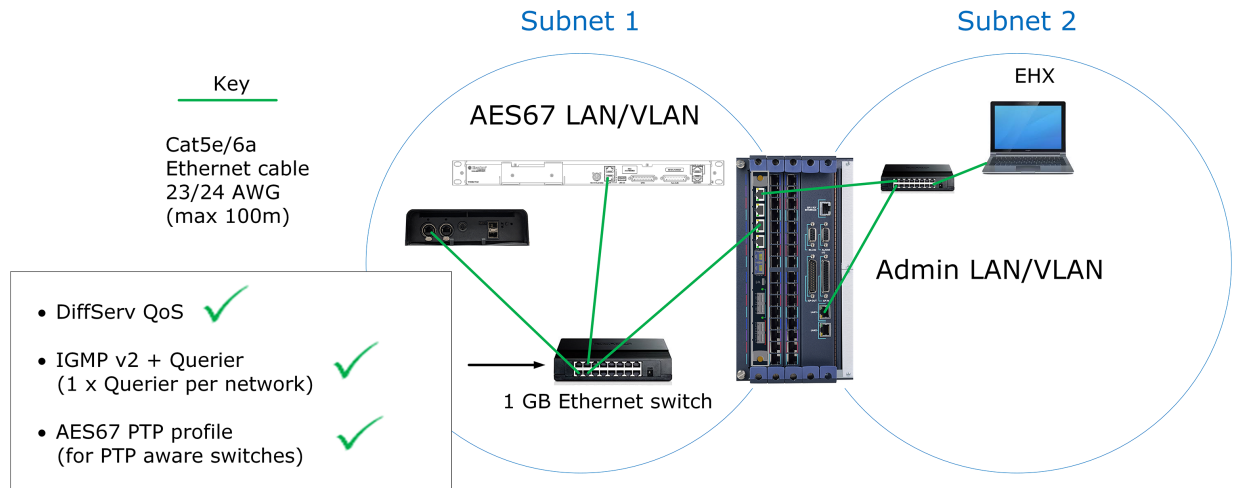

Example of matrix to AoIP devices setup

- Clear-Com recommends that you keep the AES67 ports and the Admin port of the E-IPA card separate as shown above.
- The LAN connector on the CPU card of the matrix must be on the same network as the E-IPA Admin port and the PC hosting the EHX software.

7.5.1 E-IPA Configuration rules

- **Admin & IVC** must be on different subnets if split (the default puts both Admin and IVC on the same LAN connector). The IVC connection must use a static IP address.
- AES67 must not be connected to the same LAN/VLAN as **Admin & IVC**.
- Do not connect more than one cable from the E-IPA to the same LAN/VLAN. If you do, a broadcast storm could occur.

8 Role Based Sessions Introduction

EHX v. 13.1 +

Clear-Com has extended the use of role-based intercom sessions. This means that you can move between different Clear-Com endpoint types (for example, beltpacks, virtual clients and panels) without reconfiguration or resetting of the matrix.

Devices with the roles option selected allow users to select preconfigured key and audio assignments at the device without configuration downloads.

This is an optional alternative to direct key programming.

Note: *Not available on i-Station panels.*

Note: *Not available on PiCo matrices.*

8.1 Example workflows

Morning and afternoon shift changes

A panel user can be configured with a morning configuration (for example, Rehearsal) and an afternoon configuration (Show). You will select either **Rehearsal** or **Show** role from the same hardware panel menu when you start a session at that time.

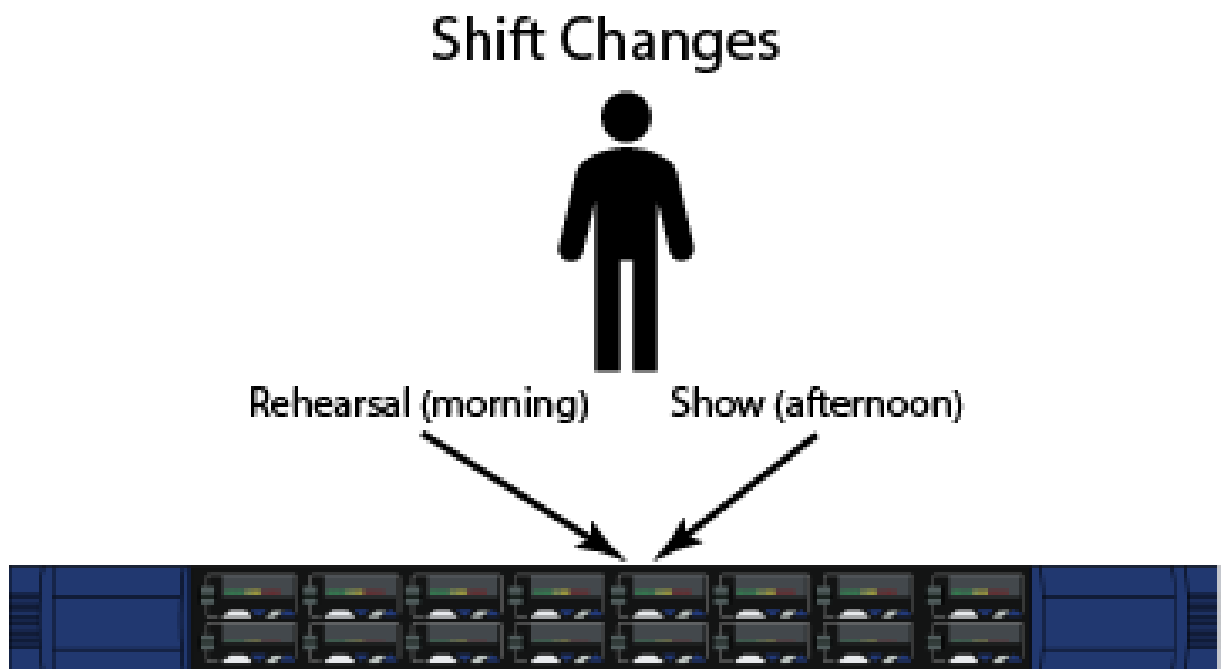

Hot desking/sharing

A panel is used during the week by the floor manager and occasionally and at weekends by engineering. There is a role called **Floor Manager** and a role called **ENG**. Each person will select the appropriate role when they start an intercom session on that panel.

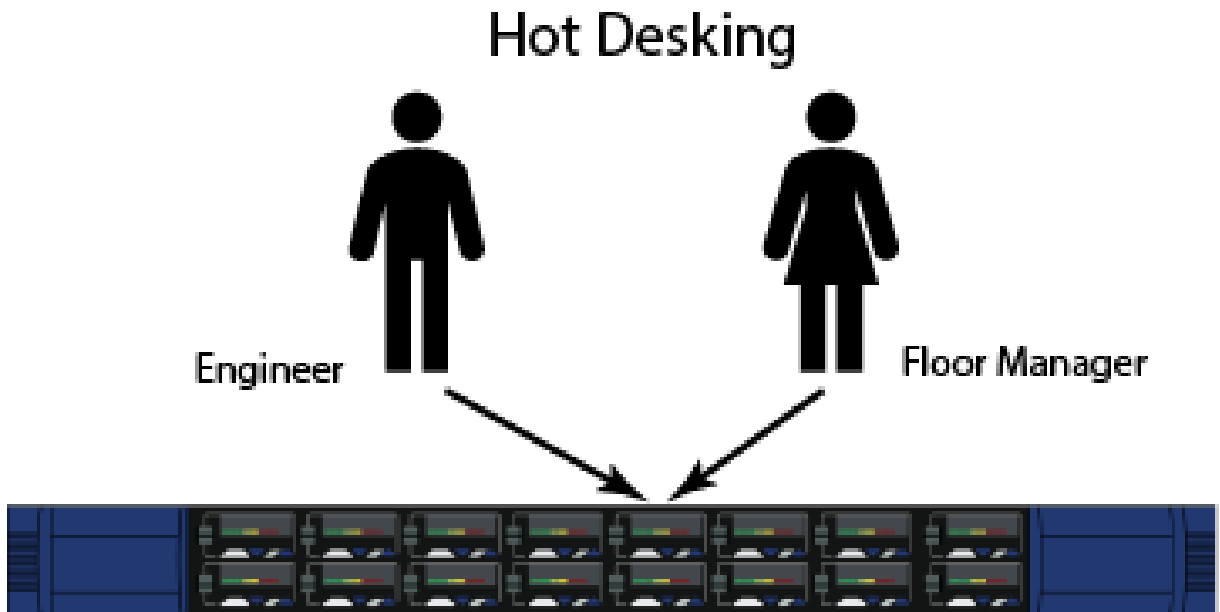

Mobile users

When using role based sessions, you have the option of transferring between panels, beltpacks and virtual clients. The matrix will perform all the required audio re-routing for you automatically without having to reconfigure all the devices for the role.

For example, a director needs to work from a panel in an outside broadcast van and then move to a wireless beltpack for the arena and then to a virtual client for a remote location. In this case, the director will have a role (**Director**) configured to work with all three devices. A mobile user might also, for example, move between a panel that is located in the racing pit area and a panel that is in the VIP viewing area.

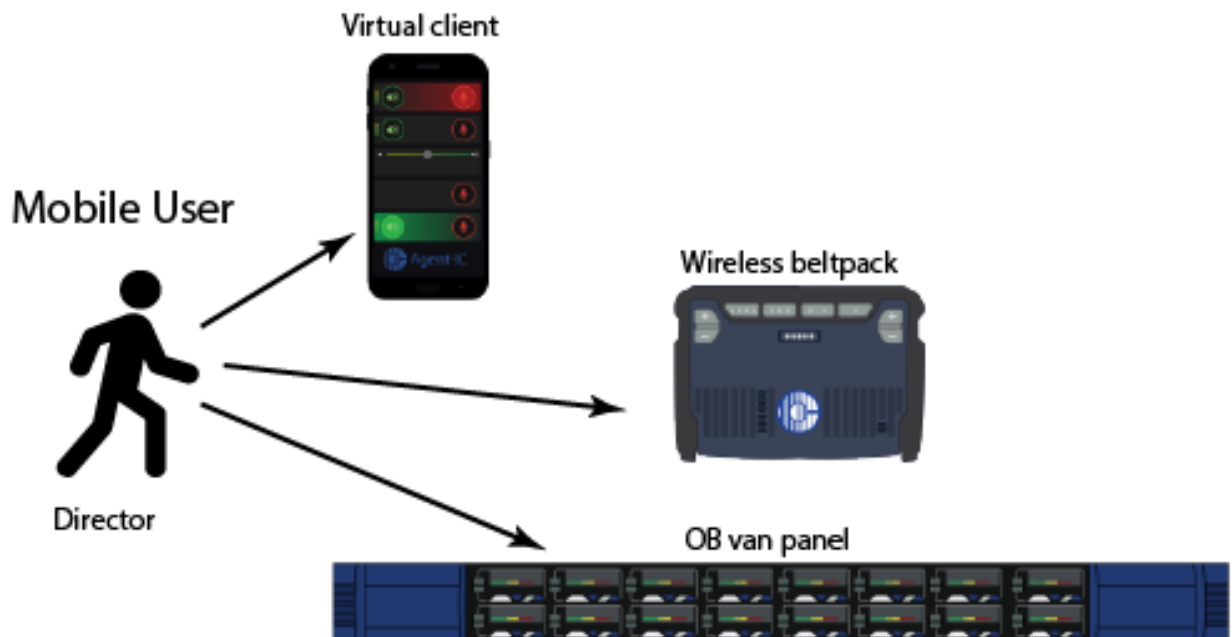

Note: A role can be set up for use with multiple device types but can only be used on one device at a time. See **Role Based Panels - Priority and Security** in the **EHX User Guide** for options.

Note: Roles can be transferred between panel types. However, when doing this, be aware that EHX will perform a best-effort auto mapping of keys. Sometimes, for instance when applying role key layouts to dissimilar panels, this will result in some keys being hidden or out of place.

8.2 Using Role based Intercom Sessions

8.2.1 Starting and ending a role based intercom session on a panel

A panel that has role sessions enabled displays 'Press Any Key to Start...' on the front panel.

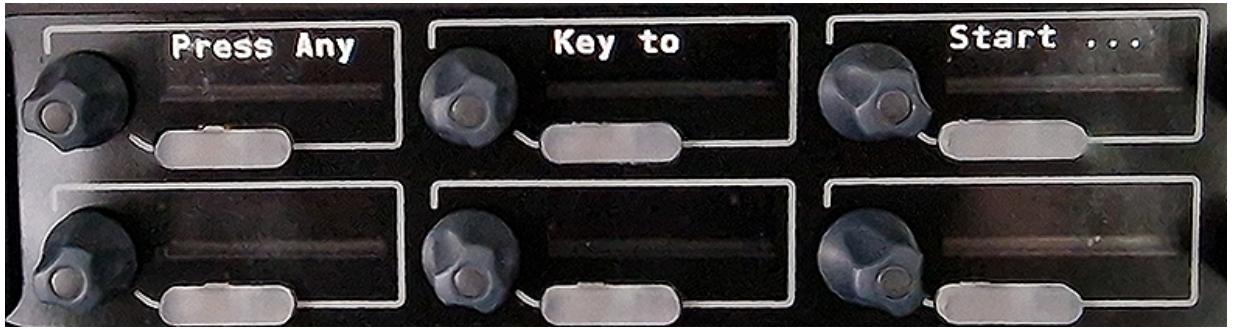

To start an intercom session, press any key, then select **Role Team** and **Role** as required using the keyset controllers. Then press **Start**. The selected role will load onto the panel.

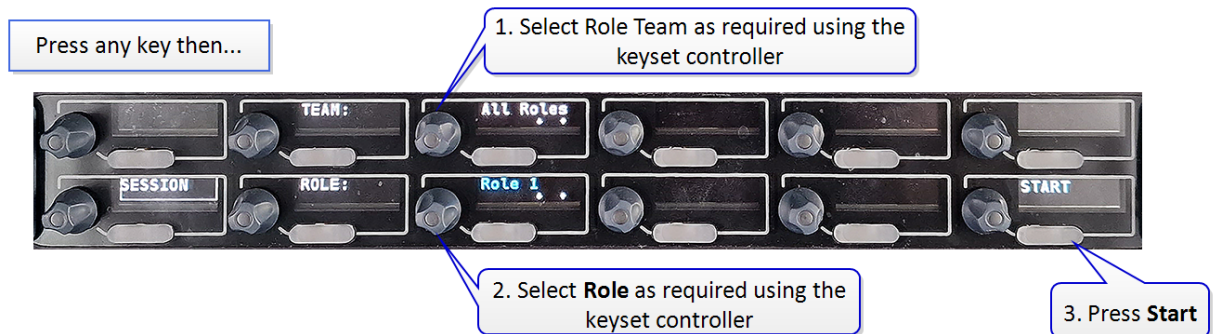

Panel role selection can be configured in EHX (**Cards and Ports** > [select port] **Port Properties** > **Role Options** > **Role Selection**) as follows:

- **Default** (preferred role team and role are at the top of the selectable list)
- **No Default** (role teams and roles are not sorted, so any configured role can be selected)
- **Fixed in EHX** (only the fixed role is available on this panel).

To end the intercom session, on the front panel press **Menu** > **End**.

Note: *Role sessions can also be ended remotely in the EHX configuration software.*

8.3 Security and priority, role based sessions

There are a number of configurable security and priority options available for role based sessions:

- **Role Access Code.** If this has been configured (EHX: **Configuration** > **Roles** > [select role] **Role Properties** > **Role Options** > **Role Access Mode**), you will be prompted for an access code whenever you start a role session with this role.
- A role can be configured for use with several different intercom endpoints (beltpack, virtual client, panel). However, a role can only be used on one device at a time. According

to permissions set in EHX (Role Options as above), a role can be selected by another device while it is in use. In this case, the device that has its session ended by another user/device will display the identity of the device that has taken the session.

See *Role Based Sessions, Priority and Security* in the *Eclipse- HX 13.1 (EHX) User Manual* for more information.

Note: *While using a role session, you can adjust panel controls to your liking. However, when the role session is ended, the next selected role session's configured settings will override your adjustments.*

9 Front panel color displays, IrisX panel

The IrisX panel takes its name from a multi-colored display designed for quick visual identification of audio entities (for instance; IFB, Partyline). The color identifications are listed below.

Note: *The key display TFTs may show some brightness variation at dim levels. This is expected for this display technology. When used at normal operating brightness, the displays should not show much variation although this may degrade slightly with age.*

Color functionality requires a matrix with Eclipse-HX 11.0 or above software installed. IrisX panels that are connected to matrices with older software installed will display white text. V-Series panels that date from before the IrisX panel do not support the color display.

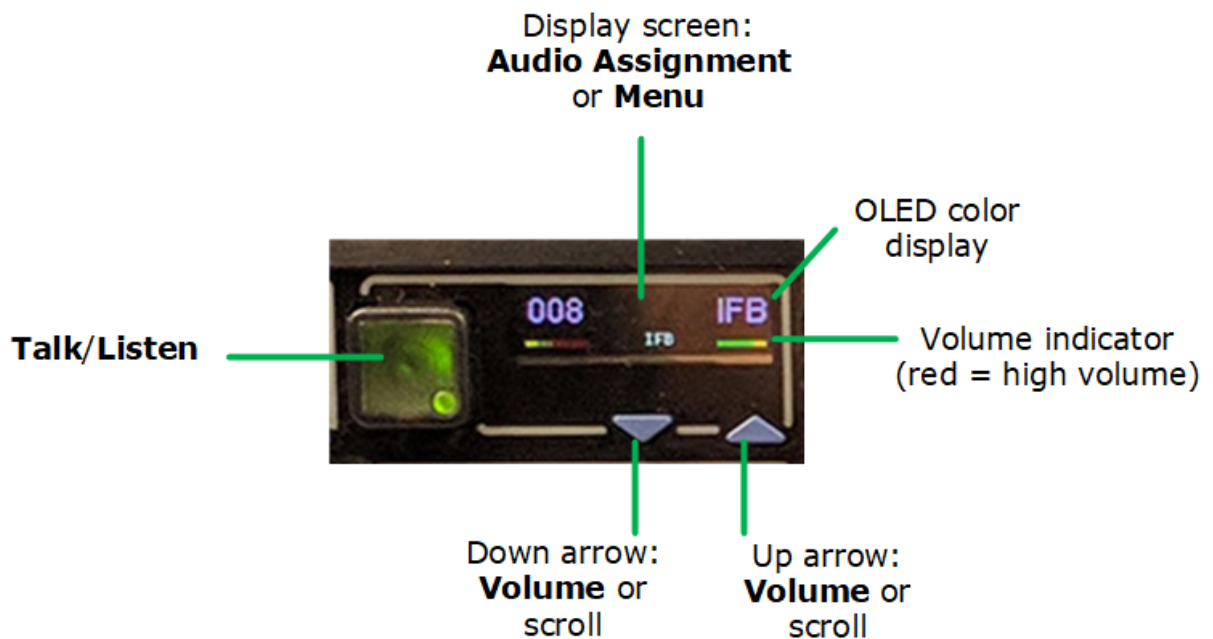

IrisX keyset color display

9.1 Default TFT colors

Entity	Default Color display
Global default	White
Interruptible Foldback (IFB)	Purple
Partyline	Yellow

Entity	Default Color display
Direct	Pink
Control	Red
Fixed Group	Aqua
Sort Group	Dark Pink
Tel14	Royal blue

Default TFT colors for IrisX panel displays

9.1.1 Change TFT colors

TFT color settings can be changed by:

- Entity type (for instance, partyline, IFB). Change TFT colors on a global level in System Preferences.
- Specific entity (for instance, color the key from a director panel red). Change TFT colors on specific devices in port properties.
- Individual key on a panel (right click on the panel mimic in EHX and select **Visual Indication Override** to activate this feature).

The color setting changes take the following priority:

1. Visual indication Override changes (priority 1)
2. Specific entity changes (priority 2)
3. Global changes from System Preferences (priority 3)

To change entity color displays, open the EHX software and navigate to **Matrix>Configuration>Preferences>System Visual Indicators**.

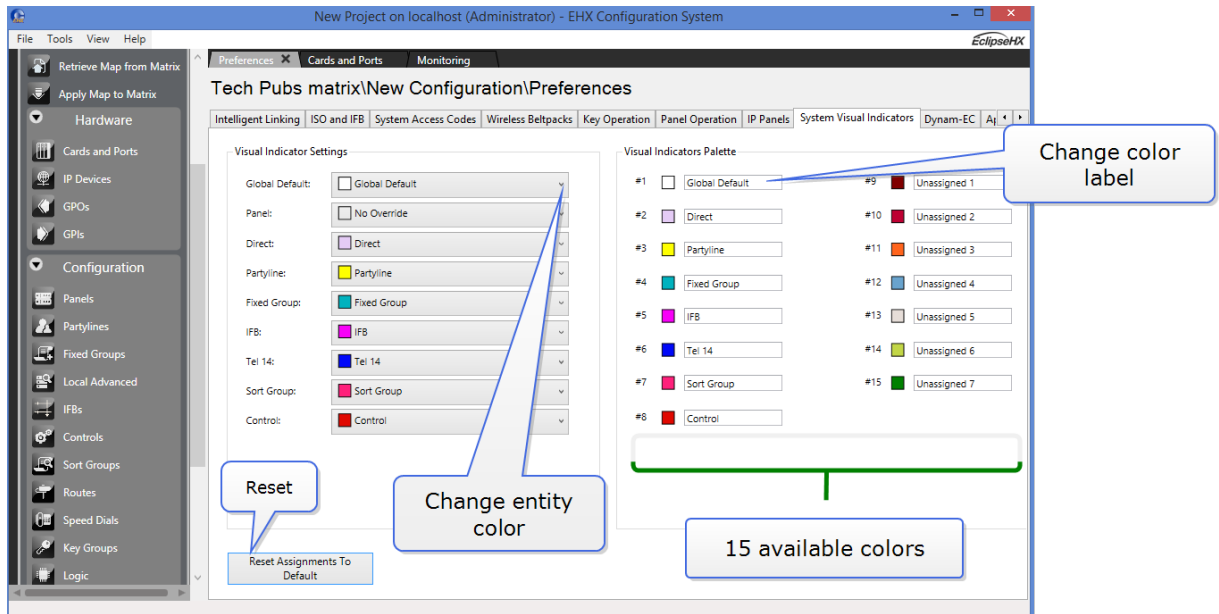

Note: You can easily reset the colors back to default settings using the **Reset Assignments to Default** button.

Set Global color display settings to first priority

If you want the Global color settings to take first priority on your panel, you can enable No Visual Indication Override from port properties.

Navigate to: **Hardware > Cards and Ports > Port Properties**

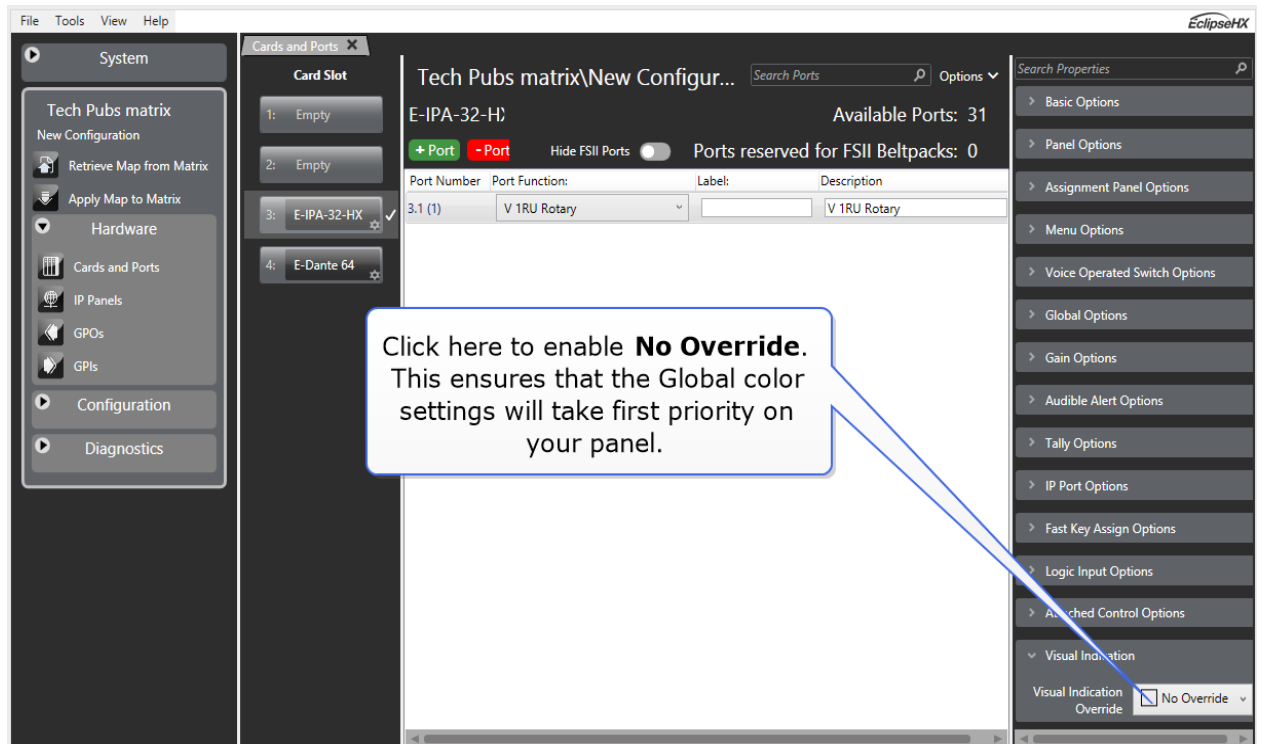

The visual indication feature has been designed for maximum flexibility in use. For more detail on how to use the color settings please see the *EHX User Guide, Chapter 17, Panel Programming, Configuring V-Series IrisX panel color displays*.

10 Using the Menu System

This chapter describes the structure and functionality of the V-Series menu system.

For a brief description of all the V-Series IrisX panels covered by this guide, including product numbers, see: [IrisX panels covered by this guide on page 9](#).

10.1 Navigating the menu system

To enter menu mode, press the menu button on the front panel to display the top level menu.

The menu LED will light and various menu options are displayed on the key displays.

Access to the System Configuration, Local Preferences and Diagnostic menus is set from EHX. Depending on the configuration, access to some or all of these menus may be disabled on the panel.

To navigate each menu level:

- On lever key or pushbutton panels, use the lever keys or pushbuttons associated with a particular menu option to select that option.

Note: Press lever keys down (*Talk*) to select menu options. The up (*Listen*) direction is not active except in the case of the *View Keys* and *Local Keys* menus, where you can use both up and down (*Talk and Listen*) key presses to select menu options.

- On rotary panels, use the talk button associated with the displayed menu option to select that option.

The selected menu options are then displayed on the panel and the process is repeated until you reach the setting you want to enable, disable or adjust.

To return to the previous menu use the Reply key talk button (which displays the name of the current menu).

To scroll through label lists:

- On lever key and pushbutton panels, use the up/down volume control buttons.
- On rotary panels, use the rotary control.

You can access the following menus directly using the dial pad on the 2RU panels:

- 1 - Dial menu
- 2 - Local Exclusive
- 3 - Local page override

- 4 - Assignment Panel menu
- 5 - Local Key Assign menu
- 7 - Local Preferences menu
- # - Fast Key Assign

For more information, see [Dial pad \(2RU panels\) on page 66](#).

10.2 Fast Key Assign

The Fast Key Assign facility on V-Series panels with dial pads enables you to create and delete local key assignments through the dial pad (see [Dial pad \(2RU panels\) on page 66](#))

This facility is enabled in EHX in Advanced Settings (see your EHX documentation).

To enter Fast Key Assign mode on a panel press the # key on the dial pad. The Reply key displays FAST ASSN.

	Label 01	Label 03	Label 05	Label 07	Label 09
▼ ▲	▼ ▲	▼ ▲	▼ ▲	▼ ▲	▼ ▲
FAST ASSN	Label 02	Label 04	Label 06	Label 08	Label 10
▼ ▲	▼ ▲	▼ ▲	▼ ▲	▼ ▲	▼ ▲

Label 01	Label 02	Label 03
▼ ▲	▼ ▲	▼ ▲
Label 04	Label 05	Label 06
▼ ▲	▼ ▲	▼ ▲
	Label 07	Label 08
▼ ▲	▼ ▲	▼ ▲
FAST ASSN	Label 09	Label 10
▼ ▲	▼ ▲	▼ ▲

10.2.1 The Dial code

The fast key assign requires 3 to 5 key presses for a dial code number to use. The dial code number will be displayed on the reply key as the user is dialing it. The first port number dial code will be 1 and all entity types will be 1 indexed.

10.2.2 Dial code validation

To terminate a Dial Code number the user must press the * key. At this point the Dial Code number is verified to see if the user is allowed to assign the entity to the panel through the sort group rules. If it is an invalid or disallowed operation then "Invalid" will be displayed on the reply key. If it is valid, then the label for the entity will be displayed on the reply key and the key labels which it can be assigned to will flash. The rack will determine if the entity is assignable by

looking in the entity table to see if the “Protect Port from Assignment” bit has been set and if the talk and listen bits are cleared. Also the Sort groups will be checked to see if the user panel is allowed to assign the entity.

Whether the key assigned has its talk or listen bits set will be determined by the default settings on the port set in EHX. Note if the talk and listen bits are set, a Talk + Listen key will be configured not a Talk + Forced Listen. On a lever or rotary V-Series panel the talk will be placed on the talk key and the listen on the listen key. The rotary encoder panel will also support talk forced listen. The force listen will be assigned to the encoder key and the talk to the push button key.

Sort groups

If the destination is a member of a valid local sort group, you can scroll the members of the sort group until you reach the desired destination by using the up/down buttons or rotary controller on the Reply key. Any member of the sort group may be selected for assignment.

Note: *If the destination port is a member of a sort group that is blocked for the panel the word **BLOCKED** is displayed in the reply key. Sort group permissions are set in EHX. For more information, see your EHX documentation.*

Assigning keys

Select one of the flashing keys by pressing one of the following:

- The pushbutton on pushbutton panels.
- The key down on lever key panels.
- The talk button on rotary panels.

The selected destination port will be assigned to that key. When a key has been assigned, the talk/listen attributes are defined in EHX. You can change the assigned key attributes later from the local panel menu.

To exit assign mode press Menu on the panel.

Fast Key Assign Sequence

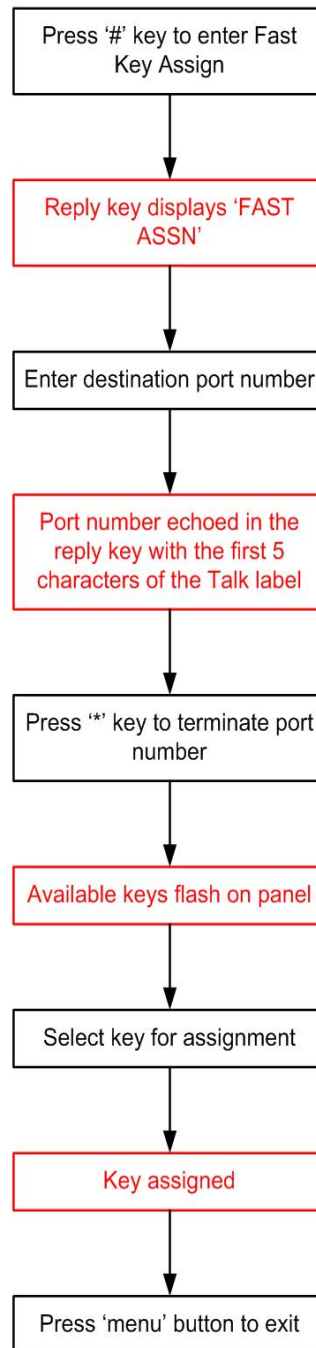

Deleting key assignments

To delete a key assignment, press the # key followed by the * key. The Reply key displays DELETE? and all the keys that can be deleted flash.

To delete the assignments on one of the flashing keys, press:

- The associated pushbutton (pushbutton panels).

- The associated key down (lever key panels).
- The associated talk button (rotary panels).

To exit delete mode press the Menu button.

10.3 Scrolling assignment

For a description of how to configure and assign sort groups from the EHX Configuration Software, see the EHX User Guide.

You can quickly assign a key to a sort group entity using the special ASSIGN key. To do this:

1. From the EHX Configuration Software, configure one or more keys as Sort Group keys. For more information, see the EHX Software Configuration Guide.
2. To enter Scrolling Assignment Mode, latch the ASSIGN key. All keys that have been configured as sort group keys will flash.

Note: *By default the first member of the sort group (sorted alphabetically) is assigned to a key.*

3. To select the required sort group entity, use the up/down button or rotary controller to scroll to the entity.

Note: *After 10 seconds of inactivity, you can no longer scroll through the entities.*

4. To exit Scrolling Assignment Mode, press the ASSIGN key.

While in Scrolling Assignment Mode, standard talk and listen keys on the panel behave as normal.

10.4 Top level menu

To enter the menu system press the Menu button on the front panel. The top level menu is displayed and the blue menu LED is lit.

From the EHX software (Configuration > Preferences > Panel & Key Operation), you can configure the Menu key to only open the Main menu after holding down the key for three seconds or longer. For more information, see the EHX Software User Guide.

Press Menu again to exit Menu mode.

SYS INFO	LOCAL PREF	SYS CONFIG	DIAL	LOCAL EXCL	ASSNMT PNL
▼ ▲	▼ ▲	▼ ▲	▼ ▲	▼ ▲	▼ ▲
MENU	MESSAGE	CALL	DIAGNOSTIC	LOCAL PAGE	SUPERVISE
▼ ▲	▼ ▲	▼ ▲	▼ ▲	▼ ▲	▼ ▲

DIAL	LOCAL EXCL	ASSNMT PNL
▼ ▲	▼ ▲	▼ ▲
DIAGNOSTIC	LOCAL PAGE	SUPERVISE
▼ ▲	▼ ▲	▼ ▲
SYS INFO	LOCAL PREF	SYS CONFIG
▼ ▲	▼ ▲	▼ ▲
MENU	MESSAGE	CALL
▼ ▲	▼ ▲	▼ ▲

The main menu options are as follows:

Menu option	Description / comments
SYS INFO	Comprises menu options that enable panel keys and nearby panels to be viewed.
LOCAL PREF	Comprises menu options that enable you to configure preferences on the panel, such as brightness levels, timeouts and audio levels.
SYS CONFIG	Comprises menu options that enable local panel configuration, input levels adjustment and output levels adjustment.
DIAL	Enables manual dialing on panel types without a dial pad.
LOCAL EXCL	Used to temporarily deactivate latched keys during talk or listen. Requires the matrix to be online.
ASSNMT PNL	Comprises menu options that enable keys to be assigned locally to IFBs, partylines and Fixed Groups.
MESSAGE	Used to record and review an outgoing audio message.
CALL	Used to place labels on the reply stack, creating a temporary user key.
DIAGNOSTIC	Provides access to the diagnostic menu options, where you can view system information, reset the panel and test audio links.
LOCAL PAGE	Enables the user to override the destination volume settings, and talk to the connected panels.
SUPERVISE	Places the panel in Supervisor mode, enabling you to supervise (take control of) other panels. The supervise option must be enabled in EHX, otherwise this menu option is not displayed. For more information, see your EHX documentation.

10.5 SYS INFO (System Information) menu

The System Information (SYS INFO) menu enables you to view all the partylines and Fixed Groups programmed on the local system.

VIEW KEYS	PARTY LINE	FIXED GRP	NEAR PNLS		
▼ ▲	▼ ▲	▼ ▲	▼ ▲	▼ ▲	▼ ▲
SYS INFO	MONITORS	FL SOURCE	FL DEST		
▼ ▲	▼ ▲	▼ ▲	▼ ▲	▼ ▲	▼ ▲

VIEW KEYS	PARTY LINE	NEAR PNLS
▼ ▲	▼ ▲	▼ ▲
	FIXED GRP	MONITORS
▼ ▲	▼ ▲	▼ ▲
	FL SOURCE	FL DEST
▼ ▲	▼ ▲	▼ ▲
SYS INFO		
▼ ▲	▼ ▲	▼ ▲

The SYS INFO menu provides access to the following options:

Menu option	Description / comments
VIEW KEYS	Enables you to view the panel key settings.
PARTY LINE	Lists both the available partylines and members of partylines.
FIXED GRP	Lists both the available Fixed Groups and members of Fixed Groups.
NEAR PNLS	List of panels configured as nearby panels in EHX.
MONITORS	List of panels monitoring this panel.
FL SOURCE	List of forced listen sources available to the panel.
FL DEST	List of forced listen destinations available to the panel.

To return to the main menu, press the Reply key / Reply key talk button (SYS INFO).

10.5.1 VIEW KEYS menu

Use the up/down volume buttons or rotary encoder on the Reply key (VIEW KEYS) to scroll through the list of key labels.

Each label displayed allows access to the configuration information for that label. To display the information (KEY INFO menu), select the label by pressing the corresponding talk/listen key or talk button.

Note: To return to the SYS INFO menu, press the Reply key / Reply key talk button (VIEW KEYS).

Label 01	Label 02	Label 04	Label 06	Label 08	Label 10
▼ ▲	▼ ▲	▼ ▲	▼ ▲	▼ ▲	▼ ▲
VIEW KEYS	Label 03	Label 05	Label 07	Label 09	Label 11
▼ ▲	▼ ▲	▼ ▲	▼ ▲	▼ ▲	▼ ▲

Label 01	Label 02	Label 03
▼ ▲	▼ ▲	▼ ▲
Label 04	Label 05	Label 06
▼ ▲	▼ ▲	▼ ▲
Label 07	Label 08	Label 09
▼ ▲	▼ ▲	▼ ▲
VIEW KEYS	Label 10	Label 11
▼ ▲	▼ ▲	▼ ▲

KEY INFO menu

The VIEW KEYS > KEY INFO menu provides information about the selected key.

Label 01	Label 01 Alias	Attributes	Label entity		
▼ ▲	▼ ▲	▼ ▲	▼ ▲	▼ ▲	▼ ▲
KEY INFO	Sys Name	LIST			
▼ ▲	▼ ▲	▼ ▲	▼ ▲	▼ ▲	▼ ▲

▼ ▲	▼ ▲	▼ ▲
Attributes		
▼ ▲	▼ ▲	▼ ▲
Label 01	Label 01 Alias	Sys Name
▼ ▲	▼ ▲	▼ ▲
KEY INFO	Label entity	LIST
▼ ▲	▼ ▲	▼ ▲

The items in italics in the above figures (together with LIST) are system and configuration dependent as follows:

Variable	Description / comments
Attributes	May be any of the following: Talk, Talk + Lstn, Talk + FL (Forced Listen), Dual T+L, Listen or Force Lstn
Sys Name	Name of the system that the entity the label refers to belongs to.
Label Entity	The type of label. May be any of the following: PORT, PL (Partyline), IFB, FG. CONTROL
LIST	Displayed if the label is a Fixed Group. Pressing this key displays a list of Fixed Group members (see [link to Fixed Group menu])

Note: To return to the VIEW KEYS menu, press the Reply key / Reply key talk button (KEY INFO).

10.5.2 PARTY LINE menu

The PARTY LINE menu option displays the partylines available to the panel.

Use the up/down volume buttons or the rotary control on the Reply key (VIEW PL) to scroll through the available partylines on the panel display.

Select one of the partylines to display the membership menu for that partyline.

To return to the SYS INFO menu, press the Reply key or Reply key talk button (VIEW PL).

	PL01	PL03	PL05	PL07	PL09
▼	▼	▼	▼	▼	▼
▲	▲	▲	▲	▲	▲
VIEW PL	PL02	PL04	PL06	PL08	PL10
▼	▼	▼	▼	▼	▼
▲	▲	▲	▲	▲	▲

PL01		PL02		PL03	
▼	▲	▼	▲	▼	▲
PL04		PL05		PL06	
▼	▲	▼	▲	▼	▲
		PL07		PL08	
▼	▲	▼	▲	▼	▲
VIEW PL		PL09		PL010	
▼	▲	▼	▲	▼	▲

PL MEMBERS menu

PL01	Label 01	Label 03	Label 05	Label 07	Label 09
▼	▲	▼	▲	▼	▲
PL MEMBERS	Label 02	Label 04	Label 06	Label 08	Label 10
▼	▲	▼	▲	▼	▲

Label 01		Label 02		Label 03	
▼	▲	▼	▲	▼	▲
Label 04		Label 05		Label 06	
▼	▲	▼	▲	▼	▲
PL01					
▼	▲	▼	▲	▼	▲
PL MEMBERS	Label 09		Label 10		
▼	▲	▼	▲	▼	▲

The PARTY LINE > PL MEMBERS menu shows you the members of the partyline you selected in the PARTY LINE menu.

Use the volume up/down buttons or the rotary control on the Reply key (PL MEMBERS) will scroll through the list of party line members.

Any members that were assigned to a partyline using Dynam-EC, rather than EHX, are not displayed. This is because Dynam-EC assignments are temporary, rather than fixed, as in the EHX configuration.

To return to the PARTY LINE menu, press the Reply key or Reply key talk button (PL MEMBERS).

10.5.3 FIXED GRP menu

The FIXED GRP menu displays a list of all the Fixed Groups available to the panel.

	FxG 01	FxG 03	FxG 05	FxG 07	FxG 09
▼ ▲	▼ ▲	▼ ▲	▼ ▲	▼ ▲	▼ ▲
VIEW FG	FxG 02	FxG 04	FxG 06	FxG 08	FxG 10
▼ ▲	▼ ▲	▼ ▲	▼ ▲	▼ ▲	▼ ▲

FxG 01		FxG 02		FxG 03	
▼	▲	▼	▲	▼	▲
FxG 04		FxG 05		FxG 06	
▼	▲	▼	▲	▼	▲
		FxG 07		FxG 08	
▼	▲	▼	▲	▼	▲
VIEW FG		FxG 09		FxG 10	
▼	▲	▼	▲	▼	▲

Use the Reply key (VIEW FG) up/down volume buttons or rotary control to scroll through the available fixed groups on the panel display.

Select one of the fixed groups to display the membership for that fixed group.

Note: *To return to the SYS INFO menu, press the Reply key or Reply key talk button (VIEW FG).*

FG MEMBERS menu

The FG MEMBERS menu displays the members of the Fixed Group that you selected in the main FIXED GRP menu.

Use the volume up/down buttons or rotary control on the Reply key (FG MEMBERS) to scroll through the devices that are members of the fixed group.

Note: *To return to the FIXED GRP menu, press the Reply key or Reply key talk button (FG MEMBERS).*

10.5.4 NEAR PNLS menu

Selecting the NEAR PNLS menu option on the main menu will display the labels associated with panels configured as Nearby Panels in EHx.

Panels designated as Nearby Panels are within hearing distance of each other, which means that an audio link between panels could result in an audio feedback loop (howlround). Audio paths to panels designated as nearby panels cannot be established.

Use the up/down volume buttons or rotary control on the Reply key (NEAR PNLS) to scroll through the list of nearby panels.

To return to the SYS INFO menu press the Reply key or Reply key talk button (NEAR PNLS).

	Label 01	Label 03	Label 05	Label 07	Label 09
▼ ▲	▼ ▲	▼ ▲	▼ ▲	▼ ▲	▼ ▲
NEAR PNLS	Label 02	Label 04	Label 06	Label 08	Label 10
▼ ▲	▼ ▲	▼ ▲	▼ ▲	▼ ▲	▼ ▲

Label 01		Label 02		Label 03	
▼	▲	▼	▲	▼	▲
Label 04		Label 05		Label 06	
▼	▲	▼	▲	▼	▲
		Label 07		Label 08	
▼	▲	▼	▲	▼	▲
NEAR PNLS		Label 09		Label 10	
▼	▲	▼	▲	▼	▲

10.5.5 MONITORS Menu

The MONITORS menu displays a list of the ports monitoring the current panel.

Use the up/down buttons or rotary control on the Reply key (MONITORS) to scroll through the list of monitoring ports.

Note: To return to the SYS INFO menu press the Reply key or Reply key talk button (MONITORS).

	Label 01	Label 03	Label 05	Label 07	Label 09
▼	▲	▼	▲	▼	▲
MONITORS	Label 02	Label 04	Label 06	Label 08	Label 10
▼	▲	▼	▲	▼	▲

Label 01		Label 02		Label 03	
▼	▲	▼	▲	▼	▲
Label 04		Label 05		Label 06	
▼	▲	▼	▲	▼	▲
		Label 07		Label 08	
▼	▲	▼	▲	▼	▲
MONITORS		Label 09		Label 10	
▼	▲	▼	▲	▼	▲

10.5.6 FL SOURCE Menu

The FL SOURCE menu option lists all the forced listen sources configured in the system.

A forced listen is a permanently enabled audio path set up in EHX between a source and a destination, allowing the destination to listen to the source without the source having to activate a talk key. For more information, see your EHX documentation.

	Label 01	Label 03	Label 05	Label 07	Label 09
▼	▲	▼	▲	▼	▲
FL SOURCE	Label 02	Label 04	Label 06	Label 08	Label 10
▼	▲	▼	▲	▼	▲

Label 01		Label 02		Label 03	
▼	▲	▼	▲	▼	▲
Label 04		Label 05		Label 06	
▼	▲	▼	▲	▼	▲
		Label 07		Label 08	
▼	▲	▼	▲	▼	▲
FL SOURCE		Label 09		Label 10	
▼	▲	▼	▲	▼	▲

Use the up/down volume buttons or rotary controller on the Reply Key (FL SOURCE) to scroll through the list of forced listen sources.

To return to the SYS INFO menu press the Reply key or Reply key talk button (FL SOURCE).

10.5.7 FL DEST menu

Pressing the FL DEST key or talk button will display all the forced listen destinations configured on the panel.

	Label 01		Label 03		Label 05		Label 07		Label 09		
▼	▲	▼	▲	▼	▲	▼	▲	▼	▲	▼	▲
FL DEST		Label 02		Label 04		Label 06		Label 08		Label 10	
▼	▲	▼	▲	▼	▲	▼	▲	▼	▲	▼	▲

Label 01		Label 02		Label 03	
▼	▲	▼	▲	▼	▲
Label 04		Label 05		Label 06	
▼	▲	▼	▲	▼	▲
		Label 07		Label 08	
▼	▲	▼	▲	▼	▲
FL DEST		Label 09		Label 10	
▼	▲	▼	▲	▼	▲

Use the volume up/down buttons or rotary control on the Reply Key (FL DEST) to scroll through the list of forced listen destinations.

Note: To return to the SYS INFO menu press the Reply key or Reply key talk button (FL DEST).

10.6 LOCAL PREF (Local Preferences) menu

Select the LOCAL PREF (Local Preferences) menu option from the main menu to display the panel setups that may be changed locally rather than in EHX.

If the PIN code has been enabled in EHX, the panel will request PIN code entry before allowing access to the local preferences menu.

0	1	2	3	4	5	6	7	8	9	*	#
▼	▲	▼	▲	▼	▲	▼	▲	▼	▲	▼	▲
LOCAL PREF		ENTER PIN		****							
▼	▲	▼	▲	▼	▲	▼	▲	▼	▲	▼	▲

1	2	3	4	5	6
▼	▲	▼	▲	▼	▲
7	8	9	0	*	#
▼	▲	▼	▲	▼	▲
ENTER PIN		****			
▼	▲	▼	▲	▼	▲
LOCAL PREF					
▼	▲	▼	▲	▼	▲

On lever key and pushbutton panels enter the PIN code using the volume up/down buttons under each number. On rotary panels, press the rotary control to select the left hand digit and the talk button to select the right hand digit in the display.

The PIN code digits will be echoed as X in the PIN code entry window.

TIMEOUTS	LEVEL ADJ				
▼	▲	▼	▲	▼	▲
LOCAL PREF	BRIGHTNESS		RESET XPTS		
▼	▲	▼	▲	▼	▲

▼ ▲	▼ ▲	▼ ▲
▼ ▲	▼ ▲	▼ ▲
BRIGHTNESS	LEVEL ADJ	TIMEOUTS
▼ ▲	▼ ▲	▼ ▲
LOCAL PREF		RESET XPTS
▼ ▲	▼ ▲	▼ ▲

The LOCAL PREF menu provides access to the following menu items:

Menu option	Description / comments
TIMEOUTS	Displays the timeouts setting menu.
LEVEL ADJ	Displays the menu to set the audio levels for the microphones, headset and loudspeaker.
BRIGHTNESS	Displays the brightness setup menu that allows the brightness of all labels and LEDs to be adjusted.
RESET XPTS	Displays the menu for resetting the panel crosspoints to default level.

To return to the main menu, press the Reply key / Reply key talk button (LOCAL PREF).

10.6.1 TIMEOUTS menu

The LOCAL PREF > TIMEOUTS menu displays the Answerback and Listen Again timeout settings.

The Answerback timeout controls the length of time an unanswered call remains in the Reply key stack. If the value is set to OFF (0 seconds) or the function is disabled, calls will remain in the Reply key stack until actioned.

The Listen Again timeout controls the length of time before recorded messages are auto deleted and may be set to a value of 0 to 99 minutes in units of 1 minute.

Note: *If the timeout is set to 99 the messages are not auto-deleted. If the timeout is set to 0 the Listen Again facility is disabled, so no audio is recorded. You can use this timeout to ensure that*

recorded conversations are not left on a panel where they may be accessed later by other operators.

ANSWERBACK	10	DISABLE			
	↓ ↑				
▼ ▲	▼ ▲	▼ ▲	▼ ▲	▼ ▲	▼ ▲
TIMEOUTS	MSG A DEL	10			
		↓ ↑			
▼ ▲	▼ ▲	▼ ▲	▼ ▲	▼ ▲	▼ ▲

ANSWERBACK	MSG A DEL	
▼ ▲	▼ ▲	▼ ▲
10	10	
↓ ↑	↓ ↑	
▼ ▲	▼ ▲	▼ ▲
ENABLE		
▼ ▲	▼ ▲	▼ ▲
TIMEOUTS		
▼ ▲	▼ ▲	▼ ▲

The TIMEOUTS menu provides access to the following menu items:

Menu option	Description / comments
ANSWERBACK	Enables you to set the panel answerback timeout. Values range from 0 (OFF) to 60 seconds in 10 second steps.
DISABLE	Disables Answerback timeout.
MSG A DEL	Enables you to set the Listen Again timeout. Values range from 0 to 99 minutes. If the timeout is set to 0 the Listen Again facility is disabled (no audio recorded). If the timeout is set to 99 the messages are not auto-deleted.

Note: To return to the LOCAL PREF menu, press the Reply key / Reply key talk button (TIMEOUTS).

10.6.2 LEVEL ADJ (Level Adjust) Menu

The LEVEL ADJ (Level Adjust) menu displays the audio levels setup menu.

	GN MIC 40	HS MIC 40	HS2MIC 40	LS DIM -12	
	↓ ↑	↓ ↑	↓ ↑	↓ ↑	
▼ ▲	▼ ▲	▼ ▲	▼ ▲	▼ ▲	▼ ▲
LEVEL ADJ	L SIDETONE	R SIDETONE	L2 SIDETONE	R2 SIDETONE	
	-----	-----	-----	-----	
▼ ▲	▼ ▲	▼ ▲	▼ ▲	▼ ▲	▼ ▲

	HS2MIC 40	
	↓ ↑	
▼ ▲	▼ ▲	▼ ▲
	L2SIDETONE	R2SIDETONE
	---	-----
▼ ▲	▼ ▲	▼ ▲
GN MIC 40	HS MIC 40	LS DIM -12
↓ ↑	↓ ↑	↓ ↑
▼ ▲	▼ ▲	▼ ▲
LEVEL ADJ	L SIDETONE	R SIDETONE
	-----	-----
▼ ▲	▼ ▲	▼ ▲

This menu adjusts the audio gain values for gooseneck panel microphone and headset microphones to preset levels of 20, 40, 50, 60, 70 or 80 db. The sidetone levels can be set for the first headset (front panel connector) and the second headset (auxiliary audio connector). Adjust the gain values and sidetone levels using the up / down buttons or the rotary control. If you change these parameters locally, the EHX software can only change it by performing a full reset. Otherwise, the EXH software can download changes without a full reset.

Menu option	Description / comments
GN MIC	Gooseneck microphone gain.
HS MIC	First headset microphone gain.
HS2MIC	Second headset microphone gain.
LS DIM	The amount the loudspeaker is dimmed by when a talk key is pressed (-70dB, -20dB, -12dB, -6dB, -3dB, 0dB).

Menu option	Description / comments
L SIDETONE	First headset left sidetone level. The key status (lever key) or pushbutton or talk button (rotary) is lit red when the left sidetone is on. To toggle left sidetone between ON and OFF press the pushbutton or press the lever key down or press the talk button (rotary). The default sidetone level is -9dB, the minimum level is -15.5dB.
R SIDETONE	First headset right sidetone level. The key status (lever key) or pushbutton or talk button (rotary) is illuminated red when the right sidetone is on. To toggle right sidetone between ON and OFF press the key pushbutton or press the lever key down or press the talk button (rotary). The default sidetone level is -9dB, the minimum level is -15.5dB.
L2SIDETONE	Second headset left sidetone level. The key status (lever key) or pushbutton or talk button (rotary) is illuminated red when the left sidetone for the second headset is on. To toggle left sidetone between ON and OFF press the key pushbutton or press the lever key down or press the talk button (rotary). The default sidetone level is -9dB, the minimum level is -15.5dB.
R2SIDETONE	Second headset right sidetone level. The key status (lever key) or pushbutton or talk button (rotary) is illuminated red when the right sidetone for the second headset is on. To toggle right sidetone between ON and OFF press the key pushbutton or press the lever key down or press the talk button (rotary). The default sidetone level is -9dB, the minimum level is -15.5dB.

When a monaural headset is used only the headset left sidetone adjust operates. The right sidetone adjust has no effect.

To return to the LOCAL PREF menu, press the Reply key / Reply key talk button (LEVELADJ).

10.6.3 BRIGHTNESS menu

The BRIGHTNESS menu enables you adjust the brightness settings for the panel.

brightness	brightness	brightness	brightness	brightness	brightness
▼ ▲	▼ ▲	▼ ▲	▼ ▲	▼ ▲	▼ ▲
BRIGHTNESS	brightness	brightness	brightness	brightness	brightness
▼ ▲	▼ ▲	▼ ▲	▼ ▲	▼ ▲	▼ ▲

brightness	brightness	brightness
▼ ▲	▼ ▲	▼ ▲
brightness	brightness	brightness
▼ ▲	▼ ▲	▼ ▲
brightness	brightness	brightness
▼ ▲	▼ ▲	▼ ▲
BRIGHTNESS	brightness	brightness
▼ ▲	▼ ▲	▼ ▲

Use the up/down buttons or rotary control on the Reply key to alter the brightness of the displays.

Note: *If you change the display brightness locally, the EHX software can only change it by performing a full reset. Otherwise, the EXH software can download changes without a black reset.*

Dim Mode

The displays automatically dim after the time limit set in EHX Panel Options (from 5 to 120 minutes) where 0 minutes sets the panel display to dim mode permanently.

The default is 20 minutes.

After a further period, the display will change to provide a screensaver to increase the lifetime of the displays (not for VI-PNLB-XXX-XX panels). For VI-PNLB-XXX-XX panels, the display will enter dark mode 180 minutes after entering dim mode.

Note: *To return to the LOCAL PREF menu, press the Reply key / Reply key talk button (BRIGHTNESS).*

10.6.4 MESSAGE menu

Use the MESSAGE menu to enable outgoing messages to be recorded, reviewed, output to audio and erased.

	RECORD	REVIEW			
▼ ▲	▼ ▲	▼ ▲	▼ ▲	▼ ▲	▼ ▲
MESSAGE	PLAY	ERASE			
▼ ▲	▼ ▲	▼ ▲	▼ ▲	▼ ▲	▼ ▲

▼ ▲	▼ ▲	▼ ▲
▼ ▲	▼ ▲	▼ ▲
	RECORD	REVIEW
▼ ▲	▼ ▲	▼ ▲
MESSAGE	PLAY	ERASE
▼ ▲	▼ ▲	▼ ▲

The MESSAGE menu provides access to the following menu options / actions:

Menu options / actions	Description / comments
RECORD	When you press the RECORD button, you can record up to 10 seconds of audio from the microphone into an audio file on the panel. Text inverts while the button is pressed.
REVIEW	When you press the REVIEW button, the outgoing message is played to the currently selected output device (Headset or Loudspeaker). Text inverts while the button is pressed.
PLAY	When you press the PLAY button, the outgoing message is output to the route configured by EHX. This will normally be Matrix 1 or Matrix 2 but may be the EXT1 or EXT2 output. Text inverts while the button is pressed.
ERASE	When you press the ERASE button, the current outgoing message is erased.
Configurable Messaging	Enables access to the Messaging menu on v-series panels. If the tick box is disabled, the panel will not show the MESSAGE menu. If the option is enabled, the panel is in the messaging menu and the PLAY button is on: <ol style="list-style-type: none"> 1. Panels with a listen to this panel will hear the recorded audio. 2. Another panel talking to this panel will also get a listen route and will be able to hear the recorded message. Note that only a maximum of 10 panels simultaneously talking to that panel will hear the recorded message if the PLAY button is on.

To return to the LOCAL PREF menu, press the Reply key / Reply key talk button (MESSAGE).

You can use the recorded output message to verify audio paths between ports.

Select a talk path set up on the panel, then enter the MESSAGE menu and press PLAY. If the talk path connects to another panel, the message is heard as an incoming talk on the target panel.

10.6.5 RESET XPTS (Reset Crosspoints) menu

The RESET XPTS menu enables you to reset the panel crosspoints to their default levels.

Press the YES key or pushbutton or talk button to reset the panel crosspoint levels to their default settings or the NO key to cancel the operation and return the user to the local preferences (LOCAL PREF) menu.

Note: *To return to the LOCAL PREF menu, press the Reply key / Reply key talk button (RESET XPTS).*

10.7 SYS CONFIG (System Configuration) menu

The SYS CONFIG (System Configuration) menu comprises menu options that enable local panel configuration, input levels adjustment and output levels adjustment.

If the PIN code has been enabled in EHX, you must enter a PIN code entry before you can access this menu.

On lever key or pushbutton panels, enter the PIN code using the volume up/down buttons under each number. On rotary panels press the rotary encoder to select the left hand digit and the talk button to select the right hand digit in the display. The PIN code digits will be shown as * in the PIN code entry window.

PARTY LINE	FIXED GRP	LOCAL PNL	REMOTE PNL		
▼ ▲	▼ ▲	▼ ▲	▼ ▲	▼ ▲	▼ ▲
SYS CONFIG	FORCE LSTN		INPUT LVLS	OUTPUT LVL	
▼ ▲	▼ ▲	▼ ▲	▼ ▲	▼ ▲	▼ ▲

	PARTY LINE	FIXED GRP
▼ ▲	▼ ▲	▼ ▲
	FORCE LSTN	
▼ ▲	▼ ▲	▼ ▲
	LOCAL PNL	INPUT LVLS
▼ ▲	▼ ▲	▼ ▲
SYS CONFIG	REMOTE PNL	OUTPUT LVL
▼ ▲	▼ ▲	▼ ▲

The SYS CONFIG menu displays the following menu options:

Menu options	Description / comments
PARTY LINE	Displays the partyline configuration menu (PL CONFIG on the Reply key). Enables interfaces and panels to be assigned to a partyline.
FIXED GRP	Displays the Fixed Group configuration menu (FG CONFIG on the Reply key). Enables interfaces and panels to be assigned to a Fixed Group.
LOCAL PNL	Displays the local panel's configuration menu.
REMOTE PNL	Displays the remote panel's configuration menu.
FORCE LSTN	Displays the Forced Listen configuration menu. Enables sources and destinations configured as keys on the current panel to be set as forced listens.
INPUT LVLS	Enables you to set input audio levels.
OUTPUT LVLS	Enables you to set output audio levels.

To return to the main menu, press the Reply key / Reply key talk button (SYS CONFIG).

10.7.1 PARTY LINE configuration menu

The SYS CONFIG > PARTY LINE menu (PL CONFIG on the Reply key) enables you to configure partylines 1 - 10 by adding panels and interfaces to the partylines as members.

	PL01	PL03	PL05	PL07	PL09
▼ ▲	▼ ▲	▼ ▲	▼ ▲	▼ ▲	▼ ▲
PL CONFIG	PL02	PL04	PL06	PL08	PL10
▼ ▲	▼ ▲	▼ ▲	▼ ▲	▼ ▲	▼ ▲

PL01	PL02	PL03
▼ ▲	▼ ▲	▼ ▲
PL04	PL05	PL06
▼ ▲	▼ ▲	▼ ▲
	PL07	PL08
▼ ▲	▼ ▲	▼ ▲
PL CONFIG	PL09	PL010
▼ ▲	▼ ▲	▼ ▲

Use the up/down volume buttons (lever key or pushbutton panels) or rotary control on the Reply Key (PL CONFIG) will scroll through the available partylines on the panel display.

Selecting one of the partylines displays the membership menu for that partyline.

Note: To return to the SYS CONFIG menu, press the Reply key / Reply key talk button (PL CONFIG).

PL MEMBERS (Partyline membership) menu

The PL CONFIG > PL MEMBERS (Partyline membership) menu enables you to add / remove interfaces and panels to / from a partyline.

PL01	INTERFACES	PANELS			
▼ ▲	▼ ▲	▼ ▲	▼ ▲	▼ ▲	▼ ▲
PL MEMBERS					
▼ ▲	▼ ▲	▼ ▲	▼ ▲	▼ ▲	▼ ▲

▼	▲	▼
▼	▲	▼
PL01	INTERFACES	PANELS
▼	▲	▼
PL MEMBERS		
▼	▲	▼

Select INTERFACES to list the interfaces that may be members of the partyline. Select PANELS to list the panels that may be members of the partyline.

Note: *To return to the PARTY LINE (PL CONFIG) menu, press the Reply key / Reply key talk button (PL MEMBERS).*

PL INTS (Interfaces) and PL PANELS (Panels) menus

Use the volume up/down buttons (lever key and pushbutton panels) or rotary control on the Reply Key (PL INTS (interfaces) or PL PANELS (panels)) to scroll through the list of possible interfaces / panels.

If the interface or panel is a member of the partyline a selection bar is displayed under the interface or panel name. To select or deselect a label or panel press the lever key/button or talk button next to the required label. The interface is either added to or removed from the party line membership.

Note: *To return to the PL MEMBERS menu, press the Reply key / Reply key talk button (PL INTS or PL PANELS).*

10.7.2 FIXED GRP configuration menu

The SYS CONFIG > FIXED GRP (FG CONFIG on the Reply key) menu enables you to configure Fixed Groups by adding and removing panels and interfaces as members.

	FxG 01	FxG 03	FxG 05	FxG 07	FxG 09
▼ ▲	▼ ▲	▼ ▲	▼ ▲	▼ ▲	▼ ▲
FG CONFIG	FxG 02	FxG 04	FxG 06	FxG 08	FxG 10
▼ ▲	▼ ▲	▼ ▲	▼ ▲	▼ ▲	▼ ▲

FxG 01		FxG 02		FxG 03	
▼	▲	▼	▲	▼	▲
FxG 04		FxG 05		FxG 06	
▼	▲	▼	▲	▼	▲
		FxG 07		FxG 08	
▼	▲	▼	▲	▼	▲
FG CONFIG		FxG 09		FxG 10	
▼	▲	▼	▲	▼	▲

Use the volume up/down buttons (lever key or pushbutton panels) or rotary control on the Reply Key (FG CONFIG) to scroll through the available fixed groups on the panel display.

Selecting one of the fixed groups will display the membership menu for that fixed group.

Note: To return to the SYS CONFIG menu, press the Reply key / Reply key talk button (FG CONFIG).

FG MEMBERS menu

When a fixed group is selected from the FIXED GRP configuration menu (FG CONFIG on the Reply key) the Fixed Group membership menu (FG MEMBERS) will be displayed.

FxG01	INTERFACES	PANELS			
▼ ▲	▼ ▲	▼ ▲	▼ ▲	▼ ▲	▼ ▲
FG MEMBERS					
▼ ▲	▼ ▲	▼ ▲	▼ ▲	▼ ▲	▼ ▲

▼ ▲	▼ ▲	▼ ▲	▼ ▲	▼ ▲	▼ ▲
▼ ▲	▼ ▲	▼ ▲	▼ ▲	▼ ▲	▼ ▲
FxG01	INTERFACES	PANELS			
▼ ▲	▼ ▲	▼ ▲	▼ ▲	▼ ▲	▼ ▲
FG MEMBERS					
▼ ▲	▼ ▲	▼ ▲	▼ ▲	▼ ▲	▼ ▲

Select INTERFACES to list the interfaces that may be members of the Fixed Group. Select PANELS to list the panels that may be members of the Fixed Group.

Note: *To return to the FIXED GRP (FG CONFIG) menu, press the Reply key / Reply key talk button (FG MEMBERS).*

FG INTS (Interfaces) and FG PANELS (Panels) menus

Use the volume up/down buttons (lever key and pushbutton panels) or rotary control on the Reply Key (FG INTS (interfaces) or FG PANELS (panels)) to scroll through the list of possible interfaces / panels.

If the interface or panel is a member of the Fixed Group a selection bar is displayed under the interface or panel name. To select or deselect a label or panel press the lever key/button or talk button next to the required label. The interface is either added to or removed from the Fixed Group membership.

Note: *To return to the FG MEMBERS menu, press the Reply key / Reply key talk button (FG INTS or FG PANELS).*

10.7.3 LOCAL PNL (Local Panel) configuration menu

Select the LOCAL PNL item in the SYS CONFIG (System Configuration) menu to display the local panel configuration menu.

LOCAL KEYS	ATTRIBUTES				
▼ ▲	▼ ▲	▼ ▲	▼ ▲	▼ ▲	▼ ▲
LOCAL PNL					
▼ ▲	▼ ▲	▼ ▲	▼ ▲	▼ ▲	▼ ▲

▼	▲	▼ ▲
▼	▲	▼ ▲
	LOCAL KEYS	ATTRIBUTES
▼	▲	▼ ▲
LOCAL PNL		
▼	▲	▼ ▲

The LOCAL PNL menu displays the following menu options:

Menu options	Description / comments
LOCAL KEYS	Use this menu to assign keys on the panel.
ATTRIBUTES	Use this menu to set the attributes of the panel keys.

Note: To return to the SYS CONFIG menu, press the Reply key / Reply key talk button (LOCAL PNL).

10.7.4 LOCAL KEYS configuration menu

The LOCAL KEYS menu enables you to both select a key and display what is configured on that key.

For lever key panels, press the key up to display the listen label, and down to display the talk label. In the case of pushbutton panels pressing the pushbutton will display the talk or listen label that is configured for that key (only one can be configured per key on a pushbutton panel).

For rotary panels press the rotary control to display the listen label and the talk button to display the talk label.

To return to the SYS CONFIG menu, press the Reply key / Reply key talk button (LOCAL KEYS).

Label 01	Label 02	Label 04	Label 06	Label 08	Label 10
▼ ▲	▼ ▲	▼ ▲	▼ ▲	▼ ▲	▼ ▲
LOCAL KEYS	Label 03	Label 05	Label 07	Label 09	Label 11
▼ ▲	▼ ▲	▼ ▲	▼ ▲	▼ ▲	▼ ▲

Label 01	Label 02	Label 03
▼ ▲	▼ ▲	▼ ▲
Label 04	Label 05	Label 06
▼ ▲	▼ ▲	▼ ▲
Label 07	Label 08	Label 09
▼ ▲	▼ ▲	▼ ▲
LOCAL KEYS	Label 10	Label 11
▼ ▲	▼ ▲	▼ ▲

KEY ASSIGN menu

Select a label on the LOCAL KEYS menu to display the KEY ASSIGN menu. The KEY ASSIGN menu displays the labels that are attached to that key.

On lever key panels, press a lever key down to show what is configured on the talk key for a label, and down to show what is configured on the listen key.

Press a pushbutton key to display the talk or listen label configured for that key.

On rotary panels, use the rotary control to scroll through the label list. Up to four labels can be configured (stacked) on a key.

You can also use KEY ASSIGN to assign a label to a key locally (without using EHX). The highlight bar is displayed below the first label on the key.

Use the up/down buttons or the rotary control on the Reply key (KEY ASSIGN) to move the highlight bar to the next key to the right (up) or left (down).

Alternatively, select the next label by pressing the label pushbutton or lever key or talk button (rotary). The highlight bar is then displayed on that label.

Controls	Description / comments
CLEAR / Talk key	Removes the highlighted label and shuffle the labels to the left.
GET LABEL / Talk key	Displays the available Sort Groups. When you select a label from a group, the label is assigned to the selected key.
OK / Talk key	Confirms the settings and returns you to the LOCAL PNL menu.

GET LABEL Menu

The KEY ASSIGN > GET LABEL menu displays the available sort groups.

Use the up / down buttons (lever key and pushbutton panels) or rotary control on the Reply key to scroll through the list of available Sort Groups. To select a sort group from the list, use the pushbutton or lever key or talk button corresponding to the display window.

The Sort Group membership menu is displayed for the selected Sort Group.

Pressing the Reply key or Reply key talk button (GET LABEL) will return to the key assign menu.

For information setting up Sort Groups, see the EHX Eclipse Configuration Software User Guide. The Sort Group menu options comprise the following:

Menu option	Description / comments
Label	Label for currently displayed key in Sort Group.
Alias Label	Alias of currently displayed key.
START	Takes you to the start of the current Sort Group.
MIDDLE	Takes you to the middle of the current Sort Group.
END	Takes you to the end of the current Sort Group.
OK	Accepts the currently displayed item and places it in the KEY ASSIGN menu.

The Reply key displays the label of the selected Sort Group. The top row shows the first member of the Sort Group.

Pressing and releasing the down button (lever key and pushbutton panels) or turning the rotary encoder anti-clockwise on the reply key will step down through the Sort Group (towards the end).

Pressing and releasing the Up button (lever key and pushbutton panels) or turning the rotary control clockwise on the Reply key will step up through the sort group (towards the start).

Pressing the Reply key or Reply key talk button will return you to the Get Label menu.

10.7.5 ATTRIBUTES menu

The LOCAL PNL > ATTRIBUTES menu enables you to set the attributes of a panel key to TALK, LISTEN, TALK + LSTN, TALK + FL or DUAL T+L.

Attribute	Description / comments
TALK	Sets a talk from this panel to a destination with no automatic listen to the destination.
LISTEN	Sets a key to listen to the source without talking to the destination at the same time. Use as a monitor key. Use the volume level up/down buttons under the display (lever key and pushbutton panels) or rotary control to increase listen level.
TALK + LSTN	Sets a talk key with listen. Use the volume level up/down buttons under the display (lever key and pushbutton panel) or rotary encoder to increase or mute the listen level.
TALK + FL	Sets a talk key with permanently made listen. Use the volume level up/down buttons under the display (lever key and pushbutton panels) or rotary encoder to increase or mute the listen level.
DUAL T + L	Sets a dual talk and listen key (used only on pushbutton panel types). Press and hold to activate a talk and listen, or press and release (less than 200ms) to latch a listen on the same pushbutton.

The attribute function

Note: *To return to the SYS CONFIG menu, press the Reply key / Reply key talk button (ATTRIBUTES).*

10.7.6 REMOTE PNL menu

The REMOTE PNL menu enables you to program keys on a remote panel. Select the remote panel from a list of available panels using the Sort Groups.

Note: *You can only use the REMOTE PNL menu to program keys on other V-Series panels of the same type (push, lever, rotary). It cannot be used to program keys on other panel types.*

	SG:01Label	SG:03Label	SG:05Label	SG:07Label	SG:09Label
▼ ▲	▼ ▲	▼ ▲	▼ ▲	▼ ▲	▼ ▲
REMOTE PNL	SG:02Label	SG:04Label	SG:06Label	SG:08Label	SG:10Label
▼ ▲	▼ ▲	▼ ▲	▼ ▲	▼ ▲	▼ ▲

SG: 01	SG: 02	SG: 03
▼ ▲	▼ ▲	▼ ▲
SG: 04	SG: 05	SG: 06
▼ ▲	▼ ▲	▼ ▲
	SG: 07	SG: 08
▼ ▲	▼ ▲	▼ ▲
REMOTE PNL	SG: 09	SG: 10
▼ ▲	▼ ▲	▼ ▲

Use the up / down buttons (lever key and pushbutton panels) or rotary control on the Reply key to scroll through the list of available Sort Groups. To select a sort group from the list, use the pushbutton or lever key or talk button corresponding to the display window.

The Sort Group membership menu is displayed for the selected Sort Group.

Note: To return to the SYS CONFIG menu, press the Reply key (REMOTE PNL).

Note: For information setting up Sort Groups, see the [\[link to Eclipse Configuration Menu\]](#).

The Sort Group menu options comprise the following:

Menu option	Description / comments
Label	Label for currently displayed key in Sort Group.
Alias Label	Alias of currently displayed key.
START	Takes you to the start of the current Sort Group.

Menu option	Description / comments
MIDDLE	Takes you to the middle of the current Sort Group.
END	Takes you to the end of the current Sort Group.
OK	Accepts the currently displayed item and you to the REMOTE PNL menu where the remote keys can be selected and the attributes of the selected remote keys set.

The Reply key displays the label of the selected Sort Group. The top row shows the first member of the Sort Group.

Pressing and releasing the down button (lever key and pushbutton panels) or turning the rotary encoder anti-clockwise on the reply key will step down through the Sort Group (towards the end).

Pressing and releasing the Up button (lever key and pushbutton panels) or turning the rotary control clockwise on the Reply key will step up through the sort group (towards the start).

Pressing the Reply key or Reply key talk button will return you to the REMOTE PNL menu.

RMT KEYS	ATTRIBUTES				
▼ ▲	▼ ▲	▼ ▲	▼ ▲	▼ ▲	▼ ▲
REMOTE PNL					OK
▼ ▲	▼ ▲	▼ ▲	▼ ▲	▼ ▲	▼ ▲

OK		
▼ ▲	▼ ▲	▼ ▲
▼ ▲	▼ ▲	▼ ▲
	RMT KEYS	ATTRIBUTES
▼ ▲	▼ ▲	▼ ▲
REMOTE PNL		
▼ ▲	▼ ▲	▼ ▲

Menu option	Description / comments
RMT KEYS	Press to assign keys on the remote panel
ATTRIBUTES	Press to set the properties of the remote panel keys.

Note: To return to the Sort Group version of the menu, press the Reply key or Reply key talk button (REMOTE PNL).

RMT KEYS menu

Use the REMOTE PNL > RMT KEYS menu to assign keys on the remote panel.

10.7.7 ATTRIBUTES menu

The REMOTE PNL > ATTRIBUTES menu allows the user to set the attributes of a panel key to TALK, LISTEN, TALK + LSTN, TALK + FL or DUAL T+L.

For definitions of the available attributes, see [ATTRIBUTES menu on page 136](#).

Note: To return to the REMOTE PNL menu, press the Reply key or Reply key talk button (ATTRIBUTES).

10.7.8 FL CONFIG (Forced Listen configuration) menu

The Forced Listen configuration menu (FL CONFIG on the Reply key) enables you to select a key and set the source or destination of that key to forced listen.

	SOURCE	DEST			
▼ ▲	▼ ▲	▼ ▲	▼ ▲	▼ ▲	▼ ▲
FL CONFIG					
▼ ▲	▼ ▲	▼ ▲	▼ ▲	▼ ▲	▼ ▲

▼ ▲	▼ ▲	▼ ▲
▼ ▲	▼ ▲	▼ ▲
FL CONFIG		
	SOURCE	DEST
▼ ▲	▼ ▲	▼ ▲
FL CONFIG		
▼ ▲	▼ ▲	▼ ▲

Menu option	Description / comments
SOURCE	Press to select forced listen sources (FL SOURCE menu).
DEST	Press to select forced listen destinations (FL DEST menu).

To return to the SYS CONFIG menu, press the Reply key or Reply key talk button (FL CONFIG).

10.7.9 FL SOURCE configuration menu

Selecting FL CONFIG > SOURCE takes you to the FL SOURCE menu.

Configuring a forced listen source creates a forced listen from the selected source to the selected key on the panel being configured. This results in the configured panel always receiving the audio from the forced listen source on that key.

To return to the FL CONFIG menu, press the Reply key or Reply key talk button (FL SOURCE).

In the FL SOURCE menu, select INTERFACES or PANELS to display a list of interfaces or panels that may be forced listen sources.

Press the volume up/down buttons (lever key and pushbutton panels) or turn the rotary control on the Reply key (FL SRC INT (Interfaces) or FL SRC PN (Panels)) to scroll through the list of possible interfaces / panels.

Press a key or talk button for a source interface / panel to select the label, and display the forced listen destination (FL DEST) menu.

FL DEST configuration menu

Selecting FL CONFIG > DEST takes you to the FL DEST menu. FL DEST is also displayed when you have selected a forced listen source (see previous section).

Configuring a forced listen destination creates a forced listen from the panel being configured to the selected destination. This results in the configured panel always sending audio to the forced listen destination.

To return to the FL CONFIG menu, press the Reply key or Reply key talk button (FL SOURCE).

In the FL DEST menu, select INTERFACES or PANELS to display a list of interfaces or panels that may be forced listen destinations.

Press the volume up/down buttons (lever key and pushbutton panels) or turn the rotary control on the Reply key (FL DST INT (Interfaces) or FL DST PN (Panels)) to scroll through the list of possible interfaces / panels.

Press a key or talk button for a source interface / panel to select the label / destination, and display the forced listen source (FL SOURCE) menu.

10.7.10 INPUT LVLS (Input Levels) configuration menu

The INPUT LVLS menu displays the Sort Groups available to the panel. Selecting one of the Sort Groups displays the membership menu for that sort group.

	SG:01Label	SG:03Label	SG:05Label	SG:07Label	SG:09Label
▼ ▲	▼ ▲	▼ ▲	▼ ▲	▼ ▲	▼ ▲
INPUT LVLS	SG:02Label	SG:04Label	SG:06Label	SG:08Label	SG:10Label
▼ ▲	▼ ▲	▼ ▲	▼ ▲	▼ ▲	▼ ▲

SG: 01		SG: 02		SG: 03	
▼	▲	▼	▲	▼	▲
SG: 04		SG: 05		SG: 06	
▼	▲	▼	▲	▼	▲
		SG: 07		SG: 08	
▼	▲	▼	▲	▼	▲
INPUT LVLS		SG: 09		SG: 10	
▼	▲	▼	▲	▼	▲

Press the up / down volume buttons (lever key and pushbutton panels) or turn the rotary control on the Reply key to scroll through the list of Sort Groups.

When a Sort Group is selected by pressing the corresponding lever key, pushbutton or talk button the Sort Group membership menu is displayed.

To return to the SYS CONFIG menu, press the Reply key or Reply key talk button (INPUT LVLS).

Setting the input levels for a label

The INPUT LVLS > Sort Group membership menu enables you to select an individual label from a Sort Group and to set the input levels for that label.

Label	Alias Label	LIST			
▼	▲	▼	▲	▼	▲
SG:02Label	START	MIDDLE	END		OK
▼	▲	▼	▲	▼	▲

OK			
▼	▲	▼	▲
START		MIDDLE	END
▼	▲	▼	▲
label		Alias label	
▼	▲	▼	▲
SG:02 label			LIST
▼	▲	▼	▲

The Sort Group menu options comprise the following:

Menu option	Description / comments
START	Takes you to the start of the current Sort Group.
MIDDLE	Takes you to the middle of the current Sort Group.
END	Takes you to the end of the current Sort Group.
OK	Press the OK key or talk button to select the port label to be configured.

The Reply key displays the label of the selected Sort Group. The top row shows the first member of the sort group.

Pressing and releasing the down button (lever key and pushbutton panels) or turning the rotary control anticlockwise on the Reply key will step down through the Sort Group towards the end of the Sort Group.

Pressing and releasing the up button (lever key and pushbutton panels) or turning the rotary control clockwise on the Reply key steps you up through the Sort Group.

Pressing the OK key or talk button to selects the port label to be configured.

Setting the input levels for the selected label

▼ ▲	▼ ▲	▼ ▲	▼ ▲	▼ ▲	▼ ▲
INPUTLEVEL	Label 01	+0 dB			RESET
▼ ▲	▼ ▲	▼ ▲	▼ ▲	▼ ▲	▼ ▲

▼ ▲	▼ ▲	▼ ▲
▼ ▲	▼ ▲	▼ ▲
Label 01		
	+0 dB	
▼ ▲	▼ ▲	▼ ▲
INPUT LEVEL	RESET	
▼ ▲	▼ ▲	▼ ▲

The +0 dB represents the input level for the audio source of the label and may be adjusted using the up and down buttons below the level display or the rotary encoder.

Select the RESET key or talk button to reset the input levels to the default of 0dB. Pressing the Reply key or Reply key talk button (INPUT LEVEL) will return you to the Sort Group menu.

When you set the input level for an audio source, you are setting the input levels for the entire matrix and not just an individual panel.

Input and output settings can only be made for the local matrix. Gains for other matrices can be achieved within EHX.

10.7.11 OUTPUT LVL (Output Levels) configuration menu

The OUTPUT LVL (Output Levels) menu displays the Sort Groups available to the panel. Selecting one of the Sort Groups displays the membership menu for that Sort Group.

	SG:01Label	SG:03Label	SG:05Label	SG:07Label	SG:09Label
▼ ▲	▼ ▲	▼ ▲	▼ ▲	▼ ▲	▼ ▲
OUTPUT LVL	SG:02Label	SG:04Label	SG:06Label	SG:08Label	SG:10Label
▼ ▲	▼ ▲	▼ ▲	▼ ▲	▼ ▲	▼ ▲

SG: 01	SG: 02	SG: 03
▼ ▲	▼ ▲	▼ ▲
SG: 04	SG: 05	SG: 06
▼ ▲	▼ ▲	▼ ▲
	SG: 07	SG: 08
▼ ▲	▼ ▲	▼ ▲
OUTPUT LVL	SG: 09	SG: 10
▼ ▲	▼ ▲	▼ ▲

10.7.12 Sort Group Menu Options

Menu option	Description / comments
START	Takes you to the start of the current Sort Group.
MIDDLE	Takes you to the middle of the current Sort Group.
END	Takes you to the end of the current Sort Group.
OK	Press the OK key or talk button to select the port label to be configured.

The Reply key displays the label of the selected Sort Group. The top row shows the first member of the sort group. Pressing and releasing the down button (lever key and pushbutton panels) or turning the rotary control anticlockwise on the Reply key will step down through the Sort Group towards the end of the Sort Group.

Pressing and releasing the up button (lever key and pushbutton panels) or turning the rotary control clockwise on the Reply key steps you up through the Sort Group.

Pressing the OK key or talk button to selects the port label to be configured.

Setting the Output Levels for the selected label

Label	Alias Label	LIST			
▼ ▲	▼ ▲	▼ ▲	▼ ▲	▼ ▲	▼ ▲
SG:02Label	START	MIDDLE	END		OK
▼ ▲	▼ ▲	▼ ▲	▼ ▲	▼ ▲	▼ ▲

OK		
▼ ▲	▼ ▲	▼ ▲
START	MIDDLE	END
▼ ▲	▼ ▲	▼ ▲
Label	Alias label	
▼ ▲	▼ ▲	▼ ▲
SG:02Label		LIST
▼ ▲	▼ ▲	▼ ▲

The +0 dB represents the output level for the audio source of the label and may be adjusted using the up and down buttons below the level display or the rotary encoder.

Select the RESET key or talk button to reset the output levels to the default of 0dB. Pressing the Reply key or Reply key talk button (OUTPUT LEVEL) will return you to the Sort Group menu.

When you set the output level for an audio source, you are setting the input levels for the entire matrix and not just an individual panel.

Input and output settings can only be made for the local matrix. Gains for other matrices can be achieved within EHX.

10.8 DIAGNOSTIC menu

The DIAGNOSTIC menu is accessed from the top level menu.

Version number

UPGRADE	0.25.0	SYSTEMDATA			
▼ ▲	▼ ▲	▼ ▲	▼ ▲	▼ ▲	▼ ▲
DIAGNOSTIC	TEST TONE	RESET PANL	TEL RELEAS		
▼ ▲	▼ ▲	▼ ▲	▼ ▲	▼ ▲	▼ ▲

▼ ▲	▼ ▲	▼ ▲
		TEL RELEASE
▼ ▲	▼ ▲	▼ ▲
UPGRADE		
Version		SYSTEM DATA
▼ ▲	▼ ▲	▼ ▲
DIAGNOSTIC	TEST TONE	RESET PANL
▼ ▲	▼ ▲	▼ ▲

The DIAGNOSTIC menu options are as follows:

Menu option	Description / comments
SYSTEMDATA	Displays the system data menu.
TEST TONE	Selecting TEST TONE turns the LED indicator red and sends a 1KHz test tone to the matrix output. Selecting Test Tone again disables the tone, and turns off the red LED. Exiting the DIAGNOSTIC menu also turns off the test tone.
RESET PANL	Selecting RESET PANL resets the panel to factory defaults. It will also delete all locally assigned keys and reset all crosspoint levels to the factory default (0dB). Panel brightness is reset to the brightness level configured for that panel in EHX.

Menu option	Description / comments
TEL RELEAS	Selecting TEL RELEAS returns the user to the Direct Access Key (DAK) page. If a telephone key is pressed the line is released. Note: The panel must also have Line Release enabled in EHX for this to take effect. This function can also be performed using the up/down volume control buttons or rotary control.
UPGRADE	Only displayed if an update is available from the matrix. Selecting this option displays the UPGRADE menu.

Note: To return to the top level menu, press the Reply key or Reply key talk button (DIAGNOSTIC).

10.8.1 Version numbers and IP address

Waiting	for	Eclipse	U 0.0.11	K 2.6.16	A 0.19.0
▼ ▲	▼ ▲	▼ ▲	▼ ▲	▼ ▲	▼ ▲
M 0.20.0	- -	- -	M 0.20.0	172.16	86.101
▼ ▲	▼ ▲	▼ ▲	▼ ▲	▼ ▲	▼ ▲

0.0.0.11	U 2.6.17	A 0.24.0
▼ ▲	▼ ▲	▼ ▲
M 0.21.0		
▼ ▲	▼ ▲	▼ ▲
Waiting	for	Eclipse
▼ ▲	▼ ▲	▼ ▲
M 0.21.0	172.16	86.101
▼ ▲	▼ ▲	▼ ▲

The version number displayed in the DIAGNOSTIC menu is for the panel application only. To obtain the version numbers of all panel firmware and the IP address of the V-Series panel, you must take the panel off line. The information given is as follows:

Example diagnostic information	Description / comments
M 0.20.0	Module application code version
U 0.0.11	Panel boot loader version
K2.6.16	Panel kernel version
A0.19.0	Panel application version
172.16.86.101	Panel IP address (if set, otherwise blank) and mDNS name.

Note: *The version and IP address information is for main panels only. Expansion panels do not display this information. You can also access version information through EHX.*

10.8.2 SYSTEM DATA menu

Select the SYSTEMDATA menu to display system information for the panel.

LD: 16:24	09/01/06	MAP: Name	NET: 12345	6789A BCDE	
▼ ▲	▼ ▲	▼ ▲	▼ ▲	▼ ▲	▼ ▲
SYSTEMDATA	PORT: 001	Label			
▼ ▲	▼ ▲	▼ ▲	▼ ▲	▼ ▲	▼ ▲

LD: 16:14	NET: 12145	6789ADCDEF
▼ ▲	▼ ▲	▼ ▲
09/01/07		
▼ ▲	▼ ▲	▼ ▲
PORT: 001	Label	SYSTEM
▼ ▲	▼ ▲	▼ ▲
SYSTEMDATA	MAP: name	
▼ ▲	▼ ▲	▼ ▲

The SYSTEM DATA menu displays the following information:

System information	Description / comments
LD	Time and date of last configuration / map download.
MAP	Name of configuration / map.
NET	Systems configured and connected to the panel
PORT	Port number of the panel
Label	Panel label

Note: To return to the *DIAGNOSTIC* menu, press the Reply key or Reply key talk button (*SYSTEMDATA*).

10.8.3 UPGRADE menu

The UPGRADE menu is displayed if:

- A panel upgrade is available from the matrix.
- The Panel Prompt option was selected in EHX.

You have the option to accept or refuse any upgrade that is offered.

You can access the UPGRADE menu from the *DIAGNOSTIC* menu. The menu is also displayed when a panel comes back online after an upgrade has been downloaded to the matrix. Flashing keys also prompt you that an upgrade is available.

Upgrade To	Version	0.29.0			
▼ ▲	▼ ▲	▼ ▲	▼ ▲	▼ ▲	▼ ▲
	YES	NO			
▼ ▲	▼ ▲	▼ ▲	▼ ▲	▼ ▲	▼ ▲

▼ ▲	▼ ▲	▼ ▲
▼ ▲	▼ ▲	▼ ▲
Upgrade To	Version	0.29.0
▼ ▲	▼ ▲	▼ ▲
	YES	NO
▼ ▲	▼ ▲	▼ ▲

Confirming the upgrade

If you select YES, the upgrade confirmation menu is displayed.

Are You	Sure	0.29.0			
▼ ▲	▼ ▲	▼ ▲	▼ ▲	▼ ▲	▼ ▲
	YES	NO			
▼ ▲	▼ ▲	▼ ▲	▼ ▲	▼ ▲	▼ ▲

▼ ▲	▼ ▲	▼ ▲
▼ ▲	▼ ▲	▼ ▲
Are You Sure 0.29.0		
▼ ▲	▼ ▲	▼ ▲
	YES	NO
▼ ▲	▼ ▲	▼ ▲

If you are sure about the upgrade, select YES. The panel is upgraded with the new download.

If you select NO, the upgrade prompt is not displayed again until the upgrade is downloaded from the matrix again.

The panel displays a message when the upgrade is complete, and then reboots to load the new application.

During the upgrade process the message UPDATE IN PROGRESS is displayed, with an indication of how far the upgrade has progressed.

For Iris panels, EHX central upgrade is only available to panels connected via AOIP.

For MVX or IVC connected panels - please use the USB upgrade method see [Upgrading the IrisX panel on page 209](#).

10.9 CALL menu

The CALL menu displays a list of sort groups from which a label can be selected and placed on the answerback stack to create a temporary key.

	SG:01Label	SG:03Label	SG:05Label	SG:07Label	SG:09Label
▼ ▲	▼ ▲	▼ ▲	▼ ▲	▼ ▲	▼ ▲
CALL	SG:02Label	SG:04Label	SG:06Label	SG:08Label	SG:10Label
▼ ▲	▼ ▲	▼ ▲	▼ ▲	▼ ▲	▼ ▲

SG: 01		SG: 02		SG: 03	
▼	▲	▼	▲	▼	▲
SG: 04		SG: 05		SG: 06	
▼	▲	▼	▲	▼	▲
		SG: 07		SG: 08	
▼	▲	▼	▲	▼	▲
CALL		SG: 09		SG: 10	
▼	▲	▼	▲	▼	▲

Use the up/down buttons (lever key and pushbutton panels) or rotary control on the Reply key to scroll through the available Sort Groups and select the name of the Sort Group containing the required label using the lever key or pushbutton or talk button.

This will display the Sort Group label selection menu. Press the Reply key or Reply key talk button (CALL) to return to the main menu.

10.9.1 Selected Sort Group in the CALL menu

Label	Alias Label				
▼	▲	▼	▲	▼	▲
SG:02Label	START	MIDDLE	END		OK
▼	▲	▼	▲	▼	▲

OK					
▼	▲	▼	▲	▼	▲
START		MIDDLE		END	
▼	▲	▼	▲	▼	▲
Label		Alias label			
▼	▲	▼	▲	▼	▲
SG:02 label					
▼	▲	▼	▲	▼	▲

The selected Sort Group label / name is displayed on the Reply key and the first member of the sort group is displayed on the top row of the display.

Selecting START will take the user to the start of the sort group. Selecting MIDDLE will take the user to the middle of the sort group, and selecting END will take the user to the end of the sort group.

Selecting OK will select the currently displayed member of the sort group and place it at the top of the answerback stack and return the user to the main CALL menu.

Note: *To call the selected label, press the Reply key to access the label from the answerback stack and call. The label is not removed from the answerback stack.*

Note: *To return to the CALL menu, press the Reply key or Reply key talk button.*

10.10 DIAL menu

The DIAL menu is provided on 1RU panels to allow users to dial telephone numbers. 2RU panels also have a dial pad for dialing telephone numbers.

To use the DIAL facility, you must first set up a key on the panel to a TEL-14 interface module. To dial out:

1. Select the TEL-14 interface module or SIP interface.

2. Use either the dial pad (if available) or the DIAL menu to dial the telephone number.

0	1	2	3	4	5	6	7	8	9	*	#
▼	▲	▼	▲	▼	▲	▼	▲	▼	▲	▼	▲
DIAL		XXXXXXX		XXXXXXX		XXXXXXX		RELEASE		REDIAL	
▼	▲	▼	▲	▼	▲	▼	▲	▼	▲	▼	▲

1	2	3	4	5	6
▼	▲	▼	▲	▼	▲
7	8	9	0	*	#
▼	▲	▼	▲	▼	▲
xxx xxx		xxx xxx		xxx xxx	
▼	▲	▼	▲	▼	▲
DIAL		RELEASE		REDIAL	
▼	▲	▼	▲	▼	▲

On lever key and pushbutton panels, pressing the up / down buttons under the numbers will dial the numbers as they are selected and enter them into the dial display on the lower line (shown as XXXX).

On rotary panels pressing the rotary control will select the left digit, while pressing the talk button will select the right digit. Telephone numbers up to 30 digits in length may be displayed. If the initial number dial is unsuccessful, select the RELEASE key to release the telephone line. Select REDIAL to dial the number saved on the lower line of the display. If you exit DIAL mode, the redial number is cleared.

The RELEASE and REDIAL keys perform the same function on 2RU panels whether the keypad or panel keys are used to dial the number.

Note: To return to the main menu, press the Reply key or Reply key talk button (DIAL).

10.10.1 Using the DIAL menu with dial pads

Using the dial pad on 2RU rack mount panels to access the DIAL menu by pressing 1 will enter a different dial menu. The labels operate as normal, and dialing out is achieved using the dial pad.

	Label 01	Label 03	Label 05	Label 07	Label 09
▼ ▲	▼ ▲	▼ ▲	▼ ▲	▼ ▲	▼ ▲
DIAL	Label 02	Label 04	Label 06	Label 08	Label 10
▼ ▲	▼ ▲	▼ ▲	▼ ▲	▼ ▲	▼ ▲

Label 01	Label 02	Label 03
▼ ▲	▼ ▲	▼ ▲
Label 04	Label 05	Label 06
▼ ▲	▼ ▲	▼ ▲
	Label 07	Label 08
▼ ▲	▼ ▲	▼ ▲
DIAL	Label 09	Label 10
▼ ▲	▼ ▲	▼ ▲

When you dial out through a TEL-14 interface module, using the DIAL menu, no outgoing audio is transmitted until you exit the DIAL menu. Incoming audio from the TEL-14 interface module can be heard, however.

10.11 LOCAL EXCL (Local Exclusive) menu

The LOCAL EXCL (Local Exclusive) menu enables you to select a single key for talk and temporarily deactivate all other latched keys on the panel.

The required key is non-latching and so must be kept pressed while local exclusive is in operation. Releasing the key will return the deactivated latched keys to their previous state.

The menu can also be entered by pressing 2 on the dial pad.

	Label 01	Label 03	Label 05	Label 07	Label 09
▼ ▲	▼ ▲	▼ ▲	▼ ▲	▼ ▲	▼ ▲
LOCAL EXCL	Label 02	Label 04	Label 06	Label 08	Label 10
▼ ▲	▼ ▲	▼ ▲	▼ ▲	▼ ▲	▼ ▲

Label 01	Label 02	Label 03
▼ ▲	▼ ▲	▼ ▲
Label 04	Label 05	Label 06
▼ ▲	▼ ▲	▼ ▲
	Label 07	Label 08
▼ ▲	▼ ▲	▼ ▲
LOCALEXCL	Label 09	Label 10
▼ ▲	▼ ▲	▼ ▲

If local exclusive is selected but no key is pressed in five seconds local exclusive mode is cancelled and the panel returns to its previous state.

The local exclusive functionality is only available when the panel is connected to a matrix and online.

10.12 LOCAL PAGE (Local Page override) menu

The LOCAL PAGE override menu allows you to talk to one or more destinations, regardless of the destination panel settings for the panel loudspeaker.

Local page override can also be accessed by pressing 3 on the panel dial pad.

	Label 01	Label 03	Label 05	Label 07	Label 09
▼ ▲	▼ ▲	▼ ▲	▼ ▲	▼ ▲	▼ ▲
LOCAL PAGE	Label 02	Label 04	Label 06	Label 08	Label 10
▼ ▲	▼ ▲	▼ ▲	▼ ▲	▼ ▲	▼ ▲

Label 01	Label 02	Label 03
▼ ▲	▼ ▲	▼ ▲
Label 04	Label 05	Label 06
▼ ▲	▼ ▲	▼ ▲
	Label 07	Label 08
▼ ▲	▼ ▲	▼ ▲
LOCAL PAGE	Label 09	Label 10
▼ ▲	▼ ▲	▼ ▲

Select any key with a label to override the local loudspeaker settings for all the destination panels associated with that key.

When the talk key is released the override function ceases, and the loudspeaker settings at the destination panels revert to their normal settings.

If no key is pressed for five seconds after entering local page override mode the panel exits local page override automatically.

To enable local page override on the panel, you must enable both page override and ensure that the page volume levels for the destination panel are set in EHX. For more information, see your EHX documentation.

10.13 ASSNMT PNL (Assignment Panel) menu

Use the ASSNMT PNL menu, to assign (and remove) sources and destinations for IFBs, partylines and Fixed Groups.

In the assignment mode, the REPLY key displays the assignment types (IFB, PL, FG) that have been enabled in EHX. Pressing the REPLY key will cycle through the available assignment types.

Note: *In addition to the main menu, you can also enter assignment panel mode through an INTERCOM key on rotary panels. The INTERCOM key will function in exactly the same way as the REPLY key.*

	Label 01	Label 03	Label 05	Label 07	Label 09
▼ ▲	▼ ▲	▼ ▲	▼ ▲	▼ ▲	▼ ▲
IFB	Label 02	Label 04	Label 06	Label 08	Label 10
▼ ▲	▼ ▲	▼ ▲	▼ ▲	▼ ▲	▼ ▲

Label 01	Label 02	Label 03
▼ ▲	▼ ▲	▼ ▲
Label 04	Label 05	Label 06
▼ ▲	▼ ▲	▼ ▲
	Label 07	Label 08
▼ ▲	▼ ▲	▼ ▲
IFB	Label 09	Label 10
▼ ▲	▼ ▲	▼ ▲

Assignment mode	Description / comments
IFB	To assign IFB sources and destinations, press the ASSNMT PNL key or talk button. IFB is displayed on the Reply key, and status LED is lit red.
PL	To make partyline assignments, press the Reply key again (currently showing IFB). PL is displayed on the Reply key.
FG	To make Fixed Group assignments, press the Reply key again (currently showing PL). FG is displayed on the Reply key. To exit assignment mode all together, press the Reply key again.

10.13.1 Assigning interruptible foldback (IFB) sources to an IFB destination

Note: *By default only one source per destination is configured. If multiple sources for an IFB destination are required, then the option to assign multiple sources to an IFB from an assignment panel (AP) must be enabled in your EHX software. For more information, see your EHX documentation.*

To assign a source to an IFB destination:

1. Press MENU to select it.

Press the ASSMNT PNL key to access the assignment menu. The REPLY key status LED lights up red and displays the available assignment modes. Toggle through the available assignment modes using the reply key until IFB ASSIGN is displayed. Valid IFB destinations will flash red.

Only assignment modes that have been configured in the EHX software will be available.

2. Press the appropriate key for the required IFB destination. The status LED for the selected key is now lit solid red.

Note: *Pressing the key again deactivates the assignment.*

3. Valid IFB sources are indicated by the status LEDs flashing green. Press the appropriate key for the required IFB source. The status LED for the selected key is now solid green and the source is assigned to the destination.

4. Pressing the key again deactivates the assignment.

Note: *To exit IFB assignment mode, press either the REPLY key or the MENU key.*

Rotary panel IFB assignment using the INTERCOM key

On a rotary control panel, the INTERCOM key can be used to access the assignment mode directly. See [Assignment Panel \(AP\) mode and the INTERCOM key on page 75](#) in this manual for more information.

1. Press the INTERCOM key. The panel will enter Assignment Panel mode and valid IFB destinations will flash red.
2. Follow steps 3 and 4 above.

Rotary panel IFB setup: setting the audio levels

On rotary panels, you can set the audio levels when assigning IFB sources and destinations using the rotary controls.

To change the audio levels:

3. Select the IFB destination (see above procedure).
4. Turn the rotary control associated with the selected IFB destination key. The display changes to show the audio level and the type of level being adjusted. When the talk button is pressed the output level to the IFB destination is set.
5. Select the IFB source(s) (see above procedure).
6. Turn the rotary control associated with the selected IFB source key. The display changes to show the audio level and the type of level being adjusted. When the talk button or rotary control is pressed the input level to the matrix is set.

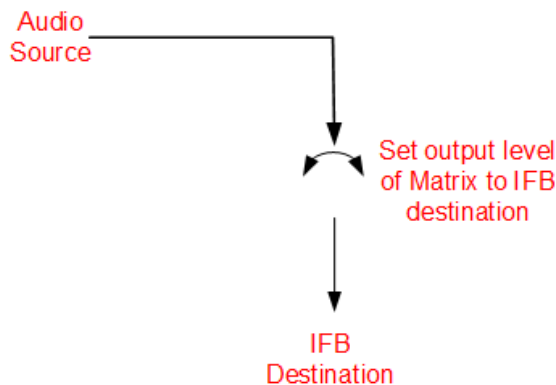

AP Mode Rotary Panel
IFB Destination Selection

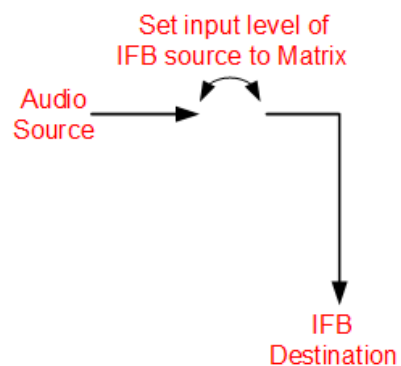

AP Mode Rotary Panel
IFB Source Selection

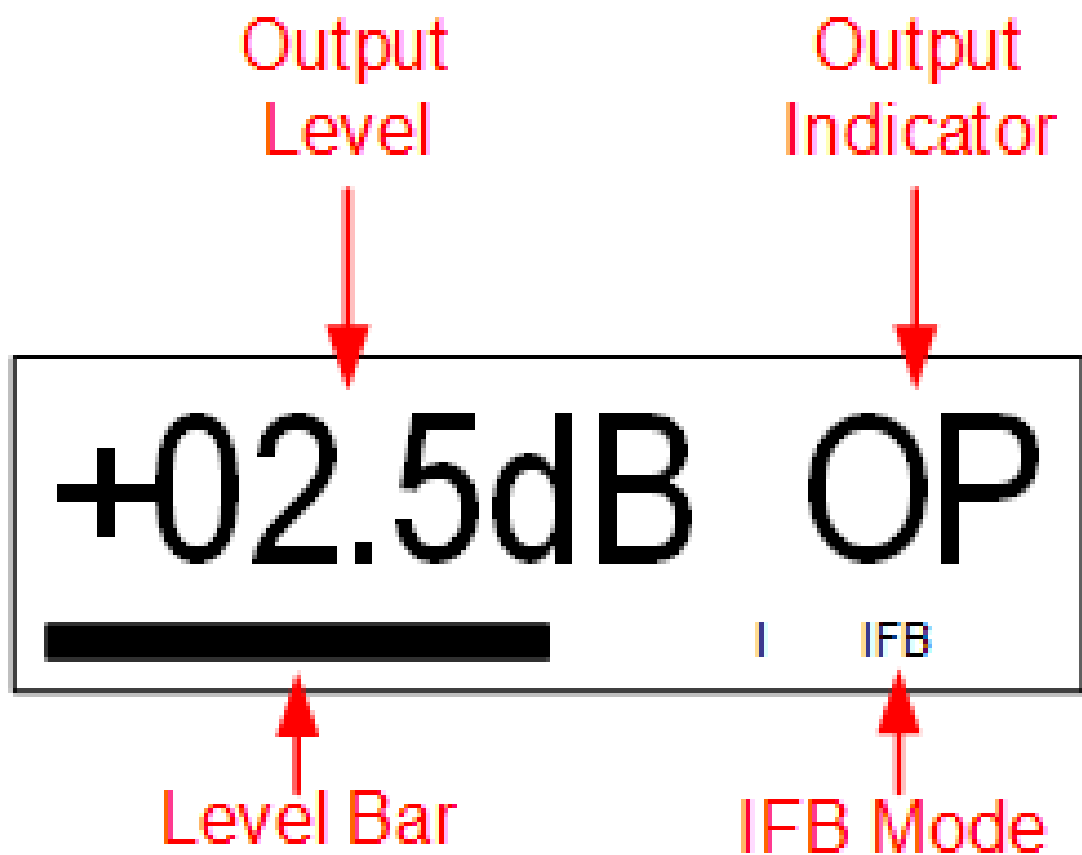
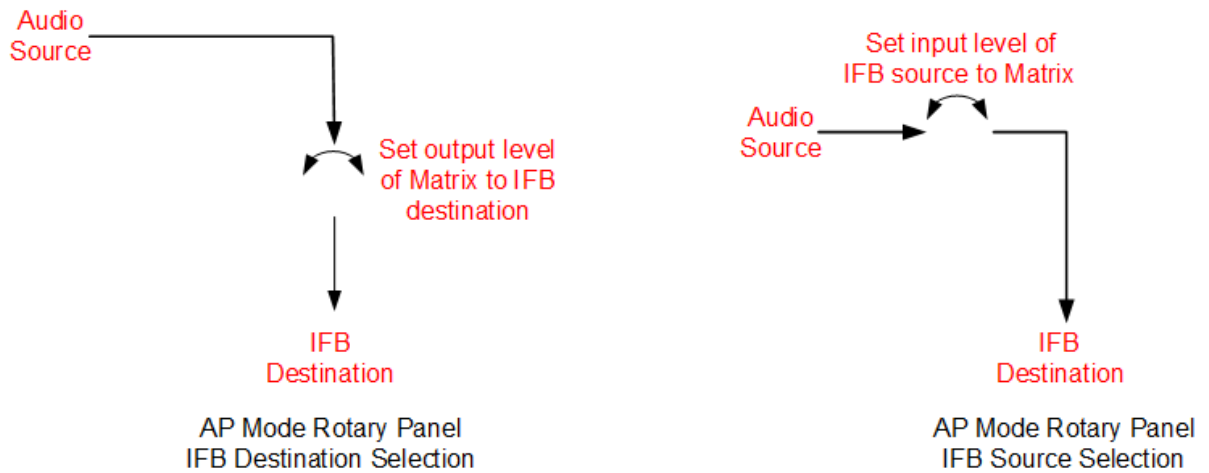

10.13.2 Assigning partyline members

To assign partyline members to a talk or listen key:

1. Press the MENU button to access the menu mode.
2. Press the ASSMNT PNL key and use the REPLY key to toggle to the partyline (PL) mode. In partyline assignment mode all available partyline status LEDs, flash red.

3. Press the key for the required partyline. The key's status LED is lit solid red and all available members' status LEDs flash green.

Note: *Only assignment modes that have been configured in the EHX software will be available.*

In the case of rotary panels if a talk label is available the talk button will flash green and if a listen label is available the rotary encoder will flash green.

4. Press the appropriate key for the required partyline member. The status LED for the selected key is now solid green and the member is added to the partyline.

Pressing the key again deactivates the assignment.

5. Repeat step 4 until the partyline contains all desired members.
6. To exit partyline assignment mode, press either the REPLY key or the MENU key.

10.13.3 Assigning Fixed Group members

To assign Fixed Group members to a talk or listen key:

1. Press the MENU button to access the menu mode.
2. Press the ASSMNT PNL key and use the REPLY key to toggle to the Fixed Group (FG) mode. In Fixed Group assignment mode all available Fixed Group status LEDs, flash red.

Note: *Only assignment modes that have been configured in the EHX software will be available.*

3. Press the key for the required Fixed Group.

The key's status LED is lit solid red and all available members' status LEDs flash green. In the case of rotary panels, if a talk label is available the talk button will flash green and if a listen label is available the rotary encoder will flash green.

4. Press a key with the associated flashing green status LED of an available member to add it to the Fixed Group.

The key's status LED becomes solid green to indicate the member has been added to the Fixed Group.

5. Repeat step 4 until the Fixed Group contains all desired members.

Note: *To remove a member from the Fixed Group, press that member's key. The solid green status LED associated with that key flashes green to indicate it is available again.*

6. To exit Fixed Group assignment mode, press either the REPLY key or the MENU key.

10.14 SUPERVISE menu

10.14.1 Supervising panels

When in Supervise mode, the V-Series panel can mimic and control other V-Series panels in the local system. This involves remote actioning of key presses and displaying a mimic of the target panel's display. While in Supervise mode, all key presses are processed at the target panel.

VI-PNLB-xxL and VI-PNLB-xxP panel types can be selected as target panels to be supervised from other lever key and pushbutton panels. Rotary panels can only supervise other rotary panels, and cannot be supervised by lever key or pushbutton panels.

The following target panel features can be mimicked or controlled:

- Audio to the target panel.
- Display text.
- Display level control bars.
- Key presses and releases.
- Cross-point level control.
- Microphone gain.
- Loudspeaker cut.
- Head-set select.
- Microphone mute.
- Side-tone control

General purpose inputs and outputs are not mimicked or remotely controllable as they may not be connected to the same hardware on the supervisor and target panels.

In particular, some of the general-purpose inputs and outputs have dedicated functions on a Supervisor Panel. Busy Feedback is not mimicked.

Pushbutton panels can supervise lever key panels but will not be able to mimic or control lever key up assignments. Only the lever key down assignments will be supervised.

10.14.2 Exiting supervise mode

To exit Supervise mode, hold down the Menu button on the dial pad for at least 3 seconds. The key displays on both panels will then return to the normal (non-supervised) state.

10.14.3 Supervisor hot key

A supervisor hot key can be configured in EHX to enable rapid entry to Supervise mode. When the supervisor hot key is selected the labels to panels which may be supervised will flash and the Reply key will display SUPERVISE in bold mode.

Pressing the Reply key or Reply key talk button will exit this mode.

The SUPERVISE menu can be accessed either via an assigned 'hot key' (see [Supervisor hot key on page 165](#) in this manual) on the panel or via the MENU system.

The SUPERVISE menu allows the user to select another panel to supervise from the panels listed in the sort groups. There is also a separate supervisor mode that is available from the EHX configuration software. For more information about this mode, see the EHX Software Configuration User Guide.

Note: *The target panel cannot be the current panel (an error message will be displayed if this is selected) and must be a V-Series panel with the same number of keys or fewer keys than the supervising panel.*

Note: *The supervise option must be enabled in EHX, otherwise this menu option is not displayed. This checkbox is found in Hardware/Cards and Ports/Properties/Menu Options within the EHX configuration software.*

EHX/Hardware/cards and ports/ Properties/Menu Options/ Supervisor Mode Access

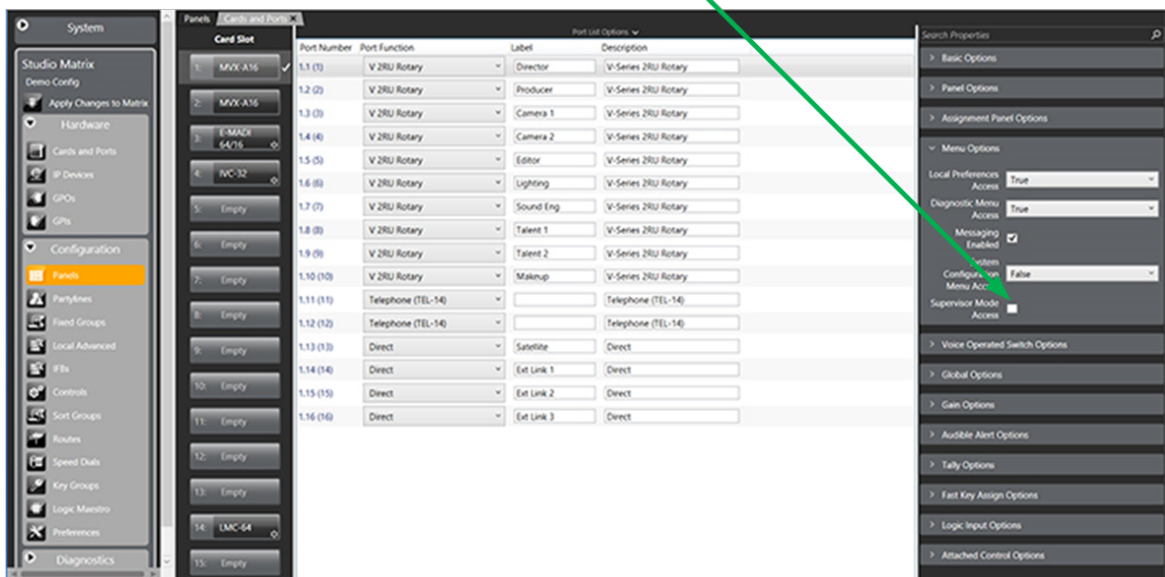

To access SUPERVISE via the panel MENU system:

1. Press the MENU key to enter menu mode.
2. Press the key labeled SUPERVISE.

3. In SUPERVISE mode (see below) follow the instructions to select a panel to control.

	SG:01Label	SG:03Label	SG:05Label	SG:07Label	SG:09Label
▼ ▲	▼ ▲	▼ ▲	▼ ▲	▼ ▲	▼ ▲
SUPERVISE	SG:02Label	SG:04Label	SG:06Label	SG:08Label	SG:10Label
▼ ▲	▼ ▲	▼ ▲	▼ ▲	▼ ▲	▼ ▲

SG: 01	SG: 02	SG: 03
▼ ▲	▼ ▲	▼ ▲
SG: 04	SG: 05	SG: 06
▼ ▲	▼ ▲	▼ ▲
	SG: 07	SG: 08
▼ ▲	▼ ▲	▼ ▲
SUPERVISE	SG: 09	SG: 10
▼ ▲	▼ ▲	▼ ▲

Use the up/down buttons (lever key and pushbutton panels) or rotary control on the Reply key to scroll through the available Sort Groups and select the name of the Sort Group containing the required label using the lever key or pushbutton or talk button.

This will display the Sort Group label selection menu.

Note: To return to the main menu, press the Reply key or Reply key talk button (SUPERVISE).

Selected Sort Group in the SUPERVISE menu

Label	Alias Label	LIST			
▼ ▲	▼ ▲	▼ ▲	▼ ▲	▼ ▲	▼ ▲
SG:02Label	START	MIDDLE	END		OK
▼ ▲	▼ ▲	▼ ▲	▼ ▲	▼ ▲	▼ ▲

OK			
▼	▲	▼	▲
START		MIDDLE	END
▼	▲	▼	▲
Label		Alias label	
▼	▲	▼	▲
SG:02 label			LIST
▼	▲	▼	▲

The selected Sort Group label / name is displayed on the Reply key and the first member of the sort group is displayed on the top row of the display.

Selecting START will take the user to the start of the sort group. Selecting MIDDLE will take the user to the middle of the sort group, and selecting END will take the user to the end of the sort group.

Selecting OK will select the currently displayed member of the sort group and place the panel corresponding to the label into supervised mode.

If the panel is unable to supervise the panel an error screen is displayed.

	Unable to	Supervise			
▼	▲	▼	▲	▼	▲
ERROR	Panel	Offline			
▼	▲	▼	▲	▼	▲

▼ ▲	▼ ▲	▼ ▲
▼ ▲	▼ ▲	▼ ▲
	Unable to	Supervise
▼ ▲	▼ ▲	▼ ▲
ERROR	Panel	Offline
▼ ▲	▼ ▲	▼ ▲

The Panel Offline error message (shown above) is displayed if the target panel cannot be supervised because it is offline.

For other errors, such as an invalid port or panel type, the Unable to Supervise message is displayed.

When the panel is actively supervising another panel the keys displayed on both panels are inverted to indicate the current state (instead of light text on a dark background the key displays will show dark text on a light background).

10.15 SHIFT menu

The SHIFT (Shift Page) menu enables access to the eight shift pages. Each shift page displays a different set of key labels.

Note: *Shift Page Mode: when the Shift Page Menu is open, the keys on the panel will be color coded.*

- Green: Keys are configured on the page
- Red: No keys are configured on the page

Note: *From the EHX software (Configuration > Preferences > Panel & Key Operation), you can configure the panel shift key to only open the shift menu after holding down the key for three seconds or longer. The usual time delay is about 500 ms. For more information, see the EHX Software User Guide.*

Note: *From the EHX software (Configuration > Preferences > Panel & Key Operation), you can configure the panel shift key to only open the shift menu if there are two or more shift pages with*

at least one key configured (not including unassigned key groups or Reply keys). For more information, see the EHX Software User Guide.

Note: Shift pages are only available on main panels and not on expansion panels.

Note: The shift page labels flash if there is an unanswered call on any key on the page.

Main	Shift 01 -----	Shift 03	Shift 05	Shift 07	
▼ ▲	▼ ▲	▼ ▲	▼ ▲	▼ ▲	▼ ▲
SHIFT	Shift 02	Shift 04	Shift 06	Shift 08	
▼ ▲	▼ ▲	▼ ▲	▼ ▲	▼ ▲	▼ ▲

	SHIFT 07	SHIFT 08
▼ ▲	▼ ▲	▼ ▲
	SHIFT 05	SHIFT 06
▼ ▲	▼ ▲	▼ ▲
Main	SHIFT 03	SHIFT 04
▼ ▲	▼ ▲	▼ ▲
SHIFT	SHIFT 01	SHIFT 02
▼ ▲	▼ ▲	▼ ▲

10.16 Menu map

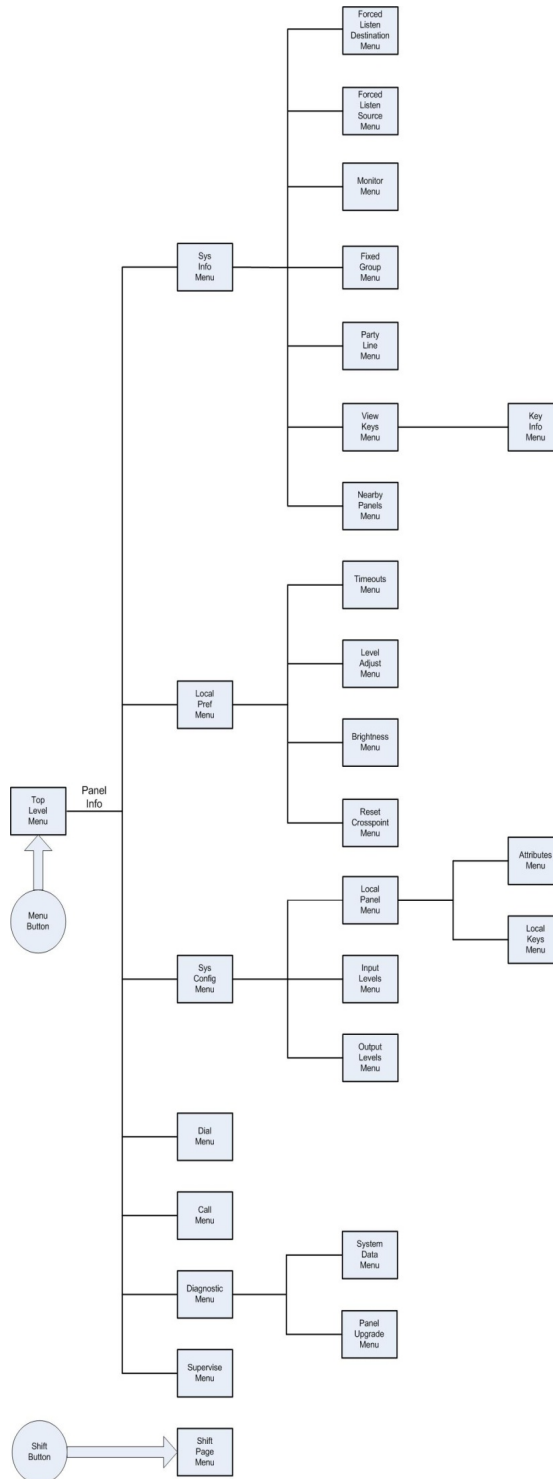

IP-enabled V-Series panels can connect to an Eclipse HX matrix over a standard Ethernet network using an IVC-32 card. Each IVC-32 card can support up to 32 V-Series panels using IP.

IP-enabled V-Series panels also support an additional two channels using IP that you can use to connect 4-wire devices directly to the panel.

The IP settings for the panel are configured using the IP configuration menus, described in this chapter.

10.17 Accessing the IP configuration menus

To access the IP menus, select **Menu >Aux L/S>Info**. The panel displays the Local Maintenance Menu (LLM). Select IP SETUP to enter the IP configuration menus.

Note: *If you enter PANEL INFO instead, you enter the maintenance menus. See [IP menu map on page 192](#).*

To communicate to EHX that the panel is ready to be identified, select IDENTIFYME.

The panel buttons or LEDs flash red and IDENTIFYME is displayed in the bottom left display screen. Select IDENTIFYME again (the Reply key) to cancel identify mode.

Identification mode can also be initiated in EHX, in which case the same display mode is seen.

Note: *If the LAN port is the only connection with the panel, the panel will automatically display the IP SETUP menu, prompting the user to enable the panel for IP access (if it is not already enabled (see above)).*

10.18 IP SETUP menu

NET SETUP	CONNECT	DISABLE			
▼ ▲	▼ ▲	▼ ▲	▼ ▲	▼ ▲	▼ ▲
IP SETUP	USER ID	PASSWORD	CNTL DELAY		
▼ ▲	▼ ▲	▼ ▲	▼ ▲	▼ ▲	▼ ▲

▼ ▲	▼ ▲	▼ ▲
CNTL DELAY		
▼ ▲	▼ ▲	▼ ▲
NET SETUP	CONNECT	DISABLE
▼ ▲	▼ ▲	▼ ▲
LOCAL MENU	USER ID	PASSWORD
▼ ▲	▼ ▲	▼ ▲

The IP SETUP menu features the following menu options:

Menu option	Description / comments
NET SETUP	Selects the NETWORK SETUP menu (see NET SETUP menu on page 180).
CONNECT	Select to initiate panel login to the matrix.
DISABLE	Disables IP connectivity on the panel. If this is selected the panel passcode must be reentered in order to enable panel IP again.
USER ID	Select to enter the user identifier the panel must use when logging in to the matrix.
PASSWORD	Select this item to enter the user password the panel must use when logging in to the matrix.
CNTL DELAY	Select to configure a delay on processing of the talk activation of the intercom keys.

10.18.1 CONNECT menu

Select CONNECT to initiate panel login to a matrix.

The panel login process has three phases:

1. The panel checks the network and attempts to reach the address of the login server.
2. The panel verifies the user ID and user password.
3. The panel completes the connection process.

Panel Conn	ecting...				
▼ ▲	▼ ▲	▼ ▲	▼ ▲	▼ ▲	▼ ▲
IP SETUP	USER ID	PASSWORD			
▼ ▲	▼ ▲	▼ ▲	▼ ▲	▼ ▲	▼ ▲

▼ ▲	▼ ▲	▼ ▲
▼ ▲	▼ ▲	▼ ▲
Panel Conn	ecting...	
▼ ▲	▼ ▲	▼ ▲
LOCAL MENU	USER ID	PASSWORD
▼ ▲	▼ ▲	▼ ▲

During phase 1 of the panel connection process, only progress messages will be displayed without status codes.

If an error occurs then one of the following status messages is displayed:

Error / status message	Description / comments
Network not connected	LAN cable not inserted. If DHCP mode selected, a DHCP server was not found.
IVC Server not found	The login server is inaccessible or not running.
Login USER xyz denied	The login server could not find an online IVC to log the panel into.

The second connection phase begins with the panel identifying itself to the host matrix. During this phase, error and status messages are displayed with status codes and sub-codes.

Code	Error / status message	Description / comments
Err 1:0	Check User ID	The name or password supplied were invalid.
Err 4:0	Media busy	The system is busy and will try again shortly.
Info 3:0	Connecting...	OK, connecting to the E-IPA or IVC-32.
Info 5:0	Reconnecting	OK (the call is being made again with new codec settings).
Err 8:0	Connection lost	The E-IPA or IVC-32 connection was lost.

If the IVC-32 card is reachable, but another error occurs that indicates a more detailed networking or configuration issue, then the error code starts with 6.

Code	Error / status message	Description / comments
Err 6:0	Local call cleared	
Err 6:1	Call rejected locally	
Err 6:2	Locally declined	
Err 6:3	Remote cleared call	E-IPA or IVC-32 has cleared the call
Err 6:4	Remote refused call	E-IPA or IVC-32 has refused to accept the call from the panel
Err 6:5	Remote ans. timeout	The E-IPA or IVC-32 has not replied to the call within the timeout period
Err 6:6	Remote stopped	E-IPA or IVC-32 card has stopped responding
Err 6:7	Transport cleared	
Err 6:8	Transport connection	
Err 6:9	Gatekeeper cleared	
Err 6:10	Cannot find user	The user name specified by the panel is not known to the target system
Err 6:11	Not enough bandwidth	The network did not have enough bandwidth available for a connection

Code	Error / status message	Description / comments
Err 6:12	No common capabilities	
Err 6:13	Call was forwarded	
Err 6:14	Bad password	The panel name or the password is incorrect
Err 6:15	Local end busy	Network congested
Err 6:16	Local end busy	Network congested
Err 6:17	Remote end busy	Network congested or E-IPA/IVC-32 busy
Err 6:18	Remote end busy	Network congested or E-IPA/IVC-32 busy
Err 6:19	Remote party unavailable.	Target E-IPA/IVC-32 could not be contacted
Err 6:20	Remote disconnected OK	The E-IPA/IVC-32 has terminated the connection
Err 6:21	Remote offline	The E-IPA/IVC-32 could not be reached
Err 6:22	Remote may retry	E-IPA or IVC-32 may retry the connect.
Err 6:23	Remote unmapped	
Err 6:24	Call duration exceeded	
Err 6:25	Invalid conference ID	
Err 6:26	Connection timed out	Network load caused disconnect

Errors are often caused by an invalid user ID or password being used. However, if the error indicates a network problem (such as insufficient bandwidth), you are advised to contact your network administrator.

10.18.2 USER ID menu

-----		01abc	2def	3ghi	4jkl
▼ ▲	▼ ▲	▼ ▲	▼ ▲	▼ ▲	▼ ▲
USER ID	5mno	6pqr	7stu	8vwx	9yz
▼ ▲	▼ ▲	▼ ▲	▼ ▲	▼ ▲	▼ ▲

01abc	2def	63ghi
▼ ▲	▼ ▲	▼ ▲
4jkl	5mno	6pqr
▼ ▲	▼ ▲	▼ ▲
7stu	8vwx	9yz
▼ ▲	▼ ▲	▼ ▲
USER ID	-----	
▼ ▲	▼ ▲	▼ ▲

The USER ID menu is used to set up the user ID that enables the panel to log in to the matrix.

The user ID:

- Must correspond to a user ID that has already been set up in EHX for a port on an IVC-32 card (Matrix Hardware > Advanced Settings > IP Panel Settings).
- Is a string of up to ten characters (0 to 9 and A to F).

Enter up to ten characters using the up/down volume buttons (lever key and pushbutton panels) or the talk button (rotary panels) to select the characters.

After each character has been selected the input will advance to the next character. Pressing the lever key down, or the pushbutton, or the rotary control will step back to the previous character.

When the user ID has been set up, exit the menu using the USER ID key or talk button.

10.18.3 PASSWORD menu

-----		01abc	2def	3ghi	4jkl
▼ ▲	▼ ▲	▼ ▲	▼ ▲	▼ ▲	▼ ▲
PASSWORD	5mno	6pqr	7stu	8vwx	9yz
▼ ▲	▼ ▲	▼ ▲	▼ ▲	▼ ▲	▼ ▲

10.18.4 Password Setup

01abc		2def		63ghi	
▼	▲	▼	▲	▼	▲
4jkl		5mno		6pqr	
▼	▲	▼	▲	▼	▲
7stu		8vwx		9yz	
▼	▲	▼	▲	▼	▲
PASSWORD		-----			
▼	▲	▼	▲	▼	▲

Use the PASSWORD menu to set up the password the panel uses to log into the matrix. The password:

- Must correspond to a password that has already been set up in EHX for a port on an IVC-32 card (Matrix Hardware > Advanced Settings > IP Panel Settings).
- Is a string of up to ten characters (0 to 9 and A to F).

Enter up to ten characters using the up/down volume buttons (lever key and pushbutton panels) or the talk button (rotary panels) to select the characters.

After each character has been selected the input will advance to the next character. Pressing the lever key down, or the pushbutton, or the rotary control will step back to the previous character.

When the password has been set up, exit the menu using the PASSWORD key or talk button.

10.18.5 CNTL DELAY (Control Delay) menu

The CNTL DELAY (Control Delay) menu enables you to configure a delay on the talk activation key up processing for intercom keys.

The delay is only applied to intercom keys (keys used to make or break of audio routes). Menu access keys are not affected.

You may want to apply a delay with certain audio links with multiple IP encodes and decodes in place (for example, panels connected over satellite links), as the link control data can overtake the audio on the link resulting in truncation of the audio.

The default setting for a delay on key up processing is 0.

The setting is held locally on the panel, which means that if the panel is moved to another port on the system, the control delay setting comes with it. The control delay must stay with the panel as it is based on geographical location, and therefore the size of audio and control latency.

The control delay range is 0ms - 9999ms. The granularity of this setting is in blocks of 50ms with the delay set being rounded down to the nearest multiple of 50ms. For example, if less than 50ms is set no delay is applied. If a multiple between 50 and 100ms is set, 50ms will be applied.

Note:

Although the CNTL DELAY menu is accessed from the top level IP settings menu, you can apply a delay to any type of connection to the matrix (enabling it to be used on four-wire based VoICE unit connections).

0	msecs		0 1	2 3	4 5
▼ ▲	▼ ▲	▼ ▲	▼ ▲	▼ ▲	▼ ▲
CNTL DELAY	CLEAR		6 7	8 9	
▼ ▲	▼ ▲	▼ ▲	▼ ▲	▼ ▲	▼ ▲

0		1		2		3		4		5	
▼	▲	▼	▲	▼	▲	▼	▲	▼	▲	▼	▲
6		7		8		9					
▼	▲	▼	▲	▼	▲	▼	▲	▼	▲	▼	▲
0			msecs								
▼	▲	▼	▲	▼	▲	▼	▲	▼	▲	▼	▲
CNTL DELAY			CLEAR								
▼	▲	▼	▲	▼	▲	▼	▲	▼	▲	▼	▲

Use the CLEAR key to clear the current control delay, and then enter the new control delay.

In lever key and pushbutton panels, use the up / down buttons to select the digits. For rotary panels, press the rotary control to select the left digit and the talk button to select the right digit.

Each time a digit is selected the cursor will advance to the next digit automatically. Pressing the lever key down or the pushbutton or the rotary control will step back to the previous digit.

When the control delay has been entered exit the menu using the CNTL DELAY key or talk button.

10.19 NET SETUP menu

The NET SETUP menu for IVC connection is shown below.

IP ADDRESS		IP GATEWAY		DNS SERVER		LOGIN IP		LOGIN PORT			
▼	▲	▼	▲	▼	▲	▼	▲	▼	▲	▼	▲
NET SETUP		DHCP		SUBNETMASK		CON TYPE		DNS/IP			
▼	▲	▼	▲	▼	▲	▼	▲	▼	▲	▼	▲

MATRIX IP		LOGIN PORT			
▼	▲	▼	▲	▼	▲
CON TYPE		DNS/IP			
▼	▲	▼	▲	▼	▲
IP ADDRESS		IP GATEWAY		DNS SERVER	
▼	▲	▼	▲	▼	▲
NET SETUP		DHCP		SUBNETMASK	
▼	▲	▼	▲	▼	▲

The NET SETUP Menu for AES67 connection is shown below.

AES67 IP		LOGIN IP		LOGIN PORT							
▼	▲	▼	▲	▼	▲	▼	▲	▼	▲	▼	▲
NET SETUP		DHCP		AES67 DHCP		CON TYPE		DNS/IP			
▼	▲	▼	▲	▼	▲	▼	▲	▼	▲	▼	▲

10.19.1 The NET SETUP Menu Options

The NET SETUP menu options are used to configure IP addresses and network connection parameters:

Menu option	Description / comments
IP ADDRESS	Used to set the IP address of the panel.
IP GATEWAY	Used to set the IP address of the gateway that the panel uses when connecting to the matrix.
DNS SERVER	Used to set the IP address of the Domain Name server used by the panel.
LOGIN IP	Used to set the IP address of the matrix the panel will connect to. The address refers to the IVC-32 card address that is set up in EHX.

Menu option	Description / comments
LOGIN PORT	<p>Used to set up the IP port that the panel uses when logging in to the matrix.</p> <p>The login port must be the same as the port set up in EHX under System Preferences > IP Panels. When the panel logs in, the panel will be sent the IP address and port to use when communicating with the IVC-32 card. This is configured in EHX under Matrix Hardware.</p>
DHCP	<p>Used to enable or disable DHCP (Dynamic Host Configuration Protocol).</p> <p>If enabled, the panel can be assigned an IP address, subnet mask, gateway address and DNS server automatically from the DHCP server rather than having to manually configure the panel.</p> <p>When DHCP is disabled, the panel can be configured manually with network parameters including the DNS server.</p>
SUBNETMASK	<p>Used to set the subnet mask for the IP network the panel is to be used on. Commonly the subnet mask will be 255.255.255.0.</p>
CON TYPE	<p>Used to determine the connection type (WAN (Wide Area Network), LAN (Local Area Network) or INTERNET).</p> <p>The connection type may determine whether DHCP and DNS are used.</p>
DNS/IP	<p>Used to switch between DNS and IP server modes. In DNS server mode, you can enter a login name for the IVC server that the panel connects to. In IP server mode you must enter the IP address of the IVC server.</p>
AES67 DHCP	<p>Used to enable or disable DHCP (Dynamic Host Configuration Protocol).</p> <p>If enabled, the panel can be assigned an IP address, subnet mask, gateway address and DNS server automatically from the DHCP server rather than having to manually configure the panel.</p>
AES67 IP	<p>When DHCP is disabled, the panel can be configured manually with network parameters including the DNS server.</p>

10.19.2 IP ADDRESS menu

123.456.	789.012		0 1	2 3	4 5
▼ ▲	▼ ▲	▼ ▲	▼ ▲	▼ ▲	▼ ▲
IP ADDRESS	CLEAR		6 7	8 9	
▼ ▲	▼ ▲	▼ ▲	▼ ▲	▼ ▲	▼ ▲

0 1	2 3	4 5
▼ ▲	▼ ▲	▼ ▲
6 7	8 9	
▼ ▲	▼ ▲	▼ ▲
123.456.	789.012	
▼ ▲	▼ ▲	▼ ▲
IP ADDRESS	CLEAR	
▼ ▲	▼ ▲	▼ ▲

Use the CLEAR key to clear the current IP address for the panel, and then enter the new IP address.

In lever key and pushbutton panels, use the up / down buttons to select the digits. For rotary panels, press the rotary control to select the left digit and the talk button to select the right digit.

Each time a digit is selected the cursor will advance to the next digit automatically. Pressing the lever key down or the pushbutton or the rotary control will step back to the previous digit.

When the IP address for the panel has been entered exit the menu using the LOGIN PORT key or talk button.

Assigning IP addresses

It is important to ensure that the panel IP address does not clash with any other IP address on the network (another device is using the same IP address). If there is an IP address clash, the panel may repeatedly lose the connection with the IVC-32 card, and may also cause the IVC-32 card to crash.

Note: Clear-Com recommends that DHCP is used wherever possible to automatically assign IP addresses rather than assigning IP addresses manually in order to reduce the risk of an address clash. For more information, see [DHCP menu on page 187](#).

10.19.3 IP GATEWAY menu

123.456.	789.012		0 1	2 3	4 5
▼ ▲	▼ ▲	▼ ▲	▼ ▲	▼ ▲	▼ ▲
IP GATEWAY	CLEAR		6 7	8 9	
▼ ▲	▼ ▲	▼ ▲	▼ ▲	▼ ▲	▼ ▲

0 1	2 3	4 5
▼ ▲	▼ ▲	▼ ▲
6 7	8 9	
▼ ▲	▼ ▲	▼ ▲
123.456.	789.012	
▼ ▲	▼ ▲	▼ ▲
IP GATEWAY	CLEAR	
▼ ▲	▼ ▲	▼ ▲

Use the CLEAR key to clear the current IP Gateway address for the panel, and then enter the new IP Gateway address.

In lever key and pushbutton panels, use the up / down buttons to select the digits. For rotary panels, press the rotary control to select the left digit and the talk button to select the right digit.

Each time a digit is selected the cursor will advance to the next digit automatically. Pressing the lever key down or the pushbutton or the rotary control will step back to the previous digit.

When the IP Gateway for the panel has been entered exit the menu using the IP GATEWAY key or talk button.

10.19.4 DNS SERVER menu

123.456.	789.012		0 1	2 3	4 5
▼ ▲	▼ ▲	▼ ▲	▼ ▲	▼ ▲	▼ ▲
DNS SERVER	CLEAR		6 7	8 9	
▼ ▲	▼ ▲	▼ ▲	▼ ▲	▼ ▲	▼ ▲

0 1	2 3	4 5
▼ ▲	▼ ▲	▼ ▲
6 7	8 9	
▼ ▲	▼ ▲	▼ ▲
123.456.	789.012	
▼ ▲	▼ ▲	▼ ▲
DNS SERVER	CLEAR	
▼ ▲	▼ ▲	▼ ▲

Use the CLEAR key to clear the current DNS Server address, and then enter the new address.

In lever key and pushbutton panels, use the up / down buttons to select the digits. For rotary panels, press the rotary control to select the left digit and the talk button to select the right digit.

Each time a digit is selected the cursor will advance to the next digit automatically. Pressing the lever key down or the pushbutton or the rotary control will step back to the previous digit.

When the DNS Server address has been entered exit the menu using the DNS SERVER key or talk button.

10.19.5 LOGIN IP menu

123.456.	789.012		0 1	2 3	4 5
▼ ▲	▼ ▲	▼ ▲	▼ ▲	▼ ▲	▼ ▲
MATRIX IP	CLEAR		6 7	8 9	
▼ ▲	▼ ▲	▼ ▲	▼ ▲	▼ ▲	▼ ▲

0 1	2 3	4 5
▼ ▲	▼ ▲	▼ ▲
6 7	8 9	
▼ ▲	▼ ▲	▼ ▲
123.456.	789.012	
▼ ▲	▼ ▲	▼ ▲
MATRIX IP	CLEAR	
▼ ▲	▼ ▲	▼ ▲

The MATRIX IP menu enables you to clear and enter a new matrix IP address.

In lever key and pushbutton panels, use the up / down buttons to select the digits. For rotary panels, press the rotary control to select the left digit and the talk button to select the right digit.

Each time a digit is selected the cursor will advance to the next digit automatically. Pressing the lever key down or the pushbutton or the rotary control will step back to the previous digit.

When the matrix IP address has been entered exit the menu using the MATRIX IP key or talk button.

10.19.6 LOGIN PORT menu

6001			0 1	2 3	4 5
▼ ▲	▼ ▲	▼ ▲	▼ ▲	▼ ▲	▼ ▲
LOGIN PORT	CLEAR		6 7	8 9	
▼ ▲	▼ ▲	▼ ▲	▼ ▲	▼ ▲	▼ ▲

0	1	2	3	4	5
▼	▲	▼	▲	▼	▲
6	7	8	9		
▼	▲	▼	▲	▼	▲
6001					
▼	▲	▼	▲	▼	▲
LOGIN PORT	CLEAR				
▼	▲	▼	▲	▼	▲

Use the CLEAR key to clear the current login port number, and then enter the new login port number.

In lever key and pushbutton panels, use the up / down buttons to select the digits. For rotary panels, press the rotary control to select the left digit and the talk button to select the right digit.

Each time a digit is selected the cursor will advance to the next digit automatically. Pressing the lever key down or the pushbutton or the rotary control will step back to the previous digit.

When the login port number has been entered exit the menu using the LOGIN PORT key or talk button.

The IP port that the panel uses when logging in to a matrix must be the same as the port set up in EHX for the matrix to listen for logins.

This may not be the same port number used by the panel to communicate with an IVC-32 card set up in EHX under Matrix Hardware.

When a panel logs in to a matrix, the matrix sends the IP address of the IVC-32 card and the port number to use back to the panel.

10.19.7 DHCP menu

ENABLE	<u>DISABLED</u>				
▼	▲	▼	▲	▼	▲
DHCP					
▼	▲	▼	▲	▼	▲

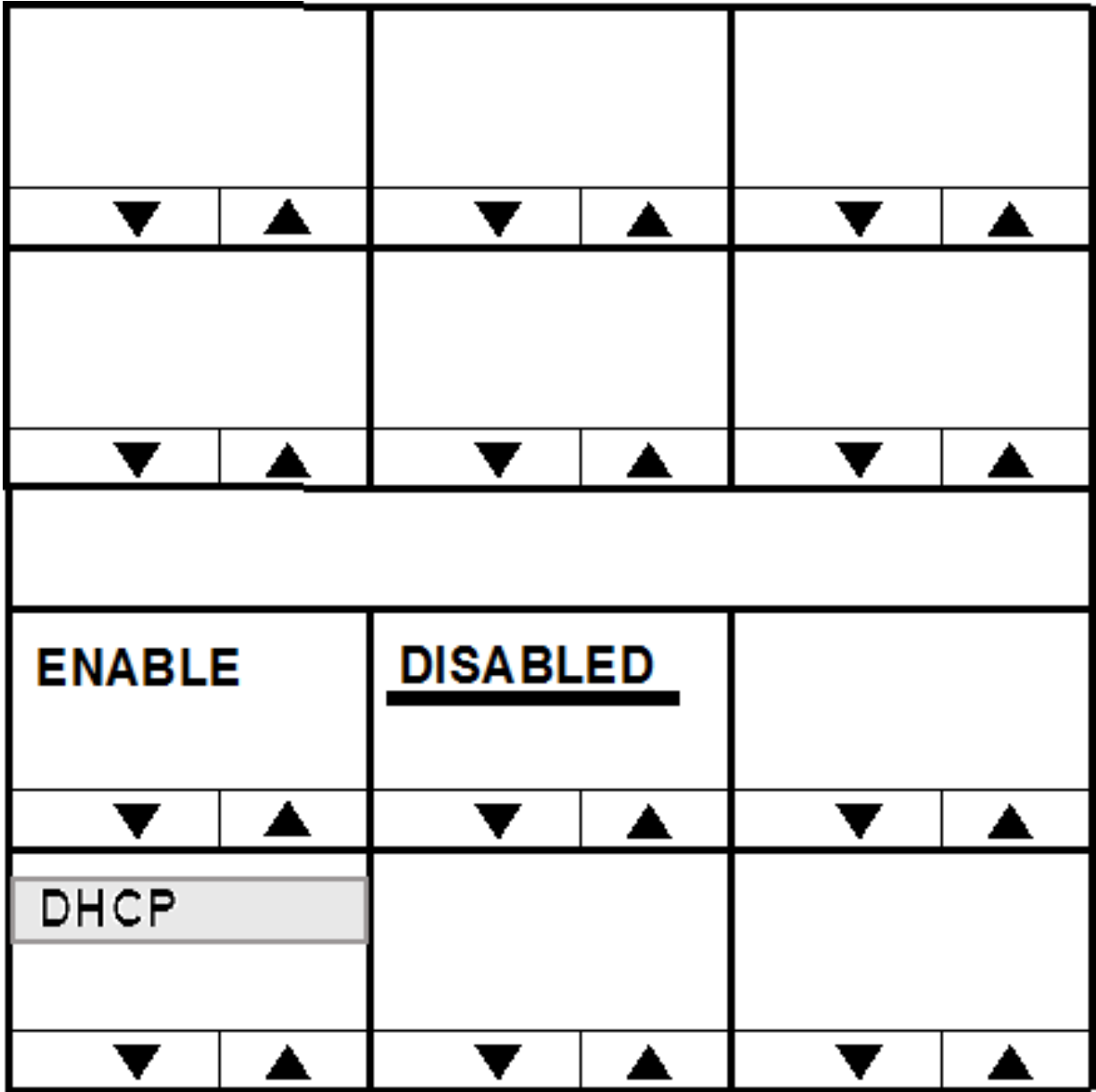

The DHCP menu enables you to enable or disable the panel using a DHCP server.

The current DHCP state is indicated by an underline. Use the ENABLE or DISABLE keys to enable or disable DHCP, and the DHCP key or talk button to exit the menu.

10.19.8 SUBNETMASK (Subnet Mask) menu

255.255.	255.000		0 1	2 3	4 5
▼ ▲	▼ ▲	▼ ▲	▼ ▲	▼ ▲	▼ ▲
SUBNETMASK	CLEAR		6 7	8 9	
▼ ▲	▼ ▲	▼ ▲	▼ ▲	▼ ▲	▼ ▲

0	1	2	3	4	5
▼	▲	▼	▲	▼	▲
6	7	8	9		
▼	▲	▼	▲	▼	▲
255.255.		255.000			
▼	▲	▼	▲	▼	▲
SUBNETMASK		CLEAR			
▼	▲	▼	▲	▼	▲

Use the CLEAR key to clear the current subnet mask, and then enter the new subnet mask.

In lever key and pushbutton panels, use the up / down buttons to select the digits. For rotary panels, press the rotary control to select the left digit and the talk button to select the right digit.

Each time a digit is selected the cursor will advance to the next digit automatically. Pressing the lever key down or the pushbutton or the rotary control will step back to the previous digit.

When the subnet mask has been entered exit the menu using the SUBNETMASK key or talk button.

10.19.9 CON TYPE (Connection Type) menu

WAN	<u>LAN</u>	INTERNET			
▼	▲	▼	▲	▼	▲
CON TYPE					
▼	▲	▼	▲	▼	▲

▼ ▲	▼ ▲	▼ ▲
▼ ▲	▼ ▲	▼ ▲
WAN		
▼ ▲	▼ ▲	▼ ▲
CON TYPE	LAN	INTERNET
▼ ▲	▼ ▲	▼ ▲

V-Series panels support three types of IP network connection:

Connection type	Description / comments
LAN	LANs (Local Area Networks) usually cover a small area, such as an office, a single building or business.
WAN	WANs (Wide Area Networks) cover a broad area and may include a number of local area networks (LANs).
Internet	Global network that may be used to connect local networks in various locations around the world.

The currently selected connection type is highlighted with a bar under the network type.

To select a connection type, press the key or talk button corresponding to the network type. The indicator bar will move to the selected type.

Press the CON TYPE key or talk button to exit.

10.19.10 DNS/IP

DNS		IP			
▼	▲	▼	▲	▼	▲
DNS/IP					
▼	▲	▼	▲	▼	▲

Connection type	Description / comments
DNS	Allows you to specify a login name for the IVC server. This name can contain up to 239 characters including the host name.
IP	Allows you to specify a login IP address for the IVC server.

Note: You can use the DNS/IP option to toggle between DNS mode and IP mode. The login name and login address will be saved. See [The NET SETUP Menu Options on page 181](#).

10.20 CONFIRM CLEAR menu

When you use the CLEAR key to clear an item (such as the current IP address or IP Gateway), a confirmation menu is displayed.

To confirm the action, select YES. To cancel the action, select NO.

The original menu is then redisplayed, with the item cleared / not cleared.

10.21 IP menu map

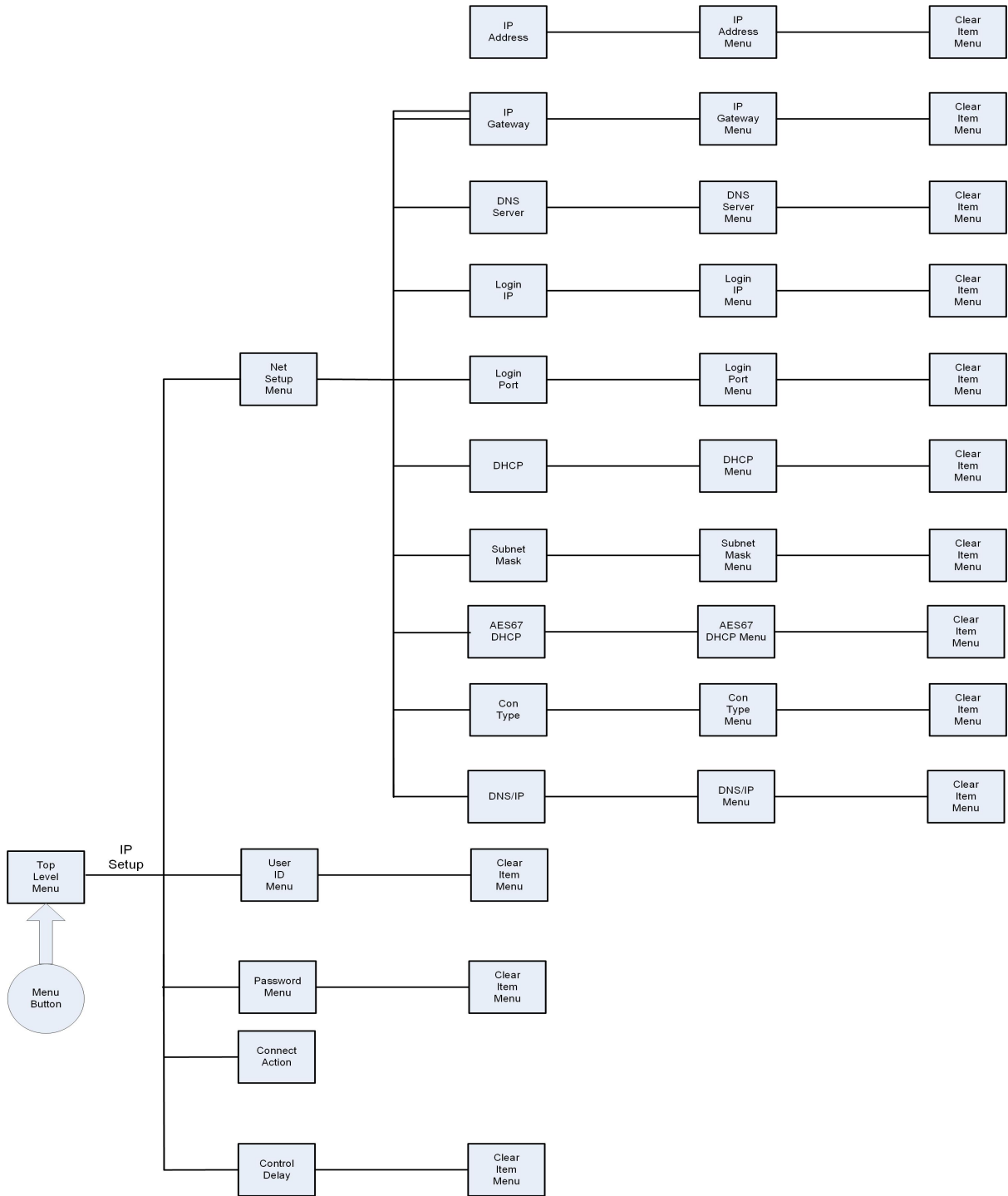

11 Maintaining V-Series Panels

This chapter describes how to use the Local Maintenance Menu (LMM) on V-Series panels. The menu is a read-only diagnostic tool, designed to help users and support engineers retrieve information about the settings and performance of panels.

11.1 Accessing the Local Maintenance Menu (LMM)

To access the Local Maintenance Menu (LMM), select Menu and then push the Info button (far bottom right on panel). Enter Panel Info. The panel displays the Local Maintenance Menu (LLM).

To exit the LLM, select Exit Local.

Note: *If you enter IP SETUP instead, you enter the IP configuration menus.*

Note: *For V-Series panel releases before v1.21 with the LMM, press Menu and then press and hold Menu again for about 7 seconds to enter the LMM when the matrix is connected. When the matrix is not connected, access the LMM by pressing and holding Menu for about 7 seconds.*

PANEL INFO	IP SETUP	IDENTIFYME			
▼ ▲	▼ ▲	▼ ▲	▼ ▲	▼ ▲	▼ ▲
EXIT	USB UPDATE				
▼ ▲	▼ ▲	▼ ▲	▼ ▲	▼ ▲	▼ ▲

▼	▲	▼
▼	▲	▼
PANEL INFO	IP SETUP	IDENTIFYME
▼	▲	▼
EXIT	USB UPDATE	
▼	▲	▼

11.2 Navigating the LLM menu

To change the commands and values use either:

- The up / down buttons under the display.
- The talk or listen lever keys associated with the display.

On a pushbutton panel, the pushbutton can also be used to scroll forwards through commands and the up button to scroll back through the commands or values.

In rotary panels, pressing the rotary control steps you forward through the commands and values. Pressing the talk button steps you back through the commands and values.

The numerical value of a command may be changed using either the Main or Aux level (volume) control.

If a command leads to an action, the relevant display will show DO IT. Pressing any key on this display actions the command, and the display will change to DONE.

11.3 Use of displays

The position of the Local Maintenance Menu (LLM) in the panel display on V-Series panels is shown below:

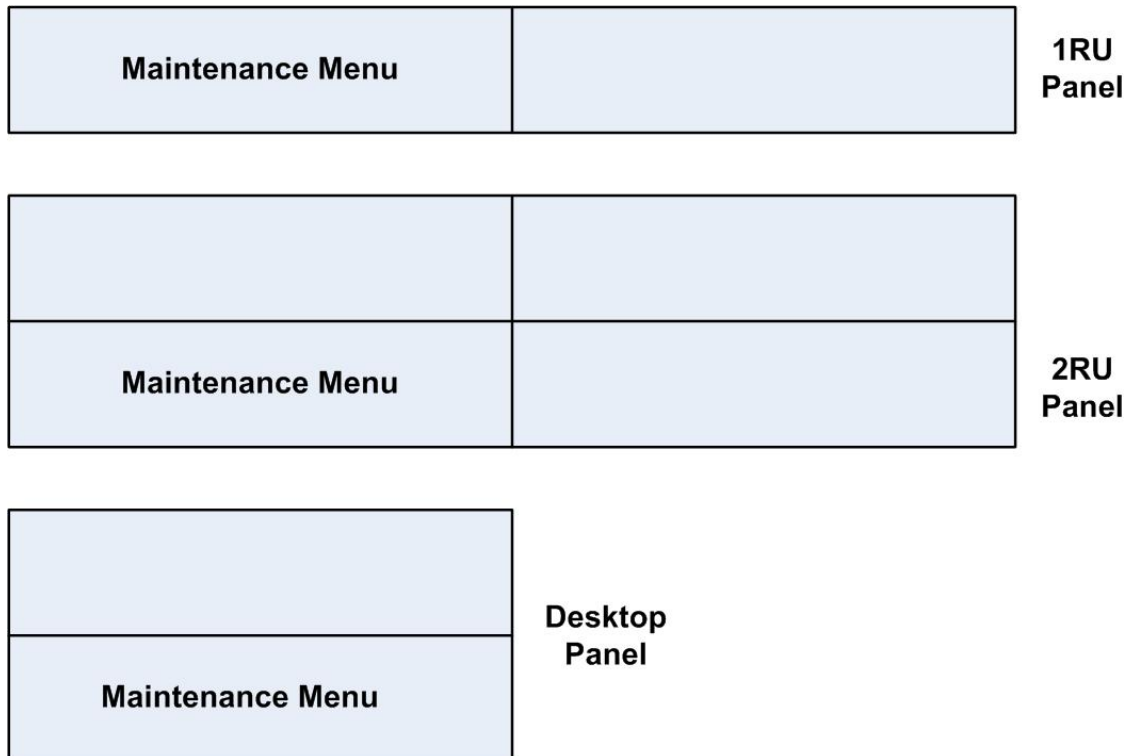

The layout for the LLM is numbered as shown below:

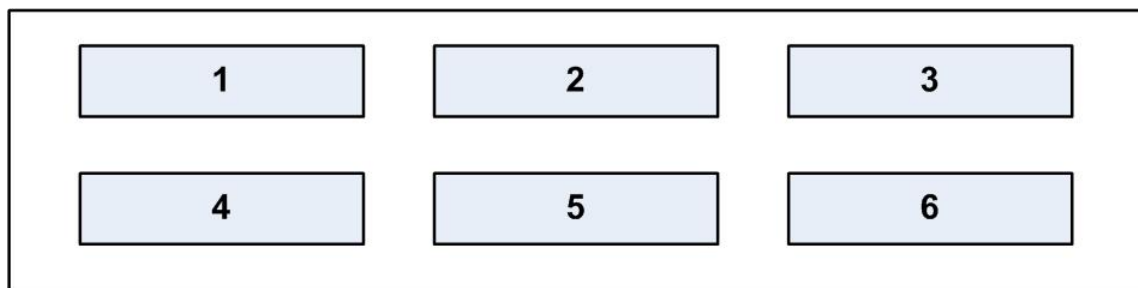

The main command appears in display 1. Displays 2-5 may show subtypes or parameters for that command.

Display 6 always shows Exit Local.

11.4 Commands

The command always appears in window 1.

To scroll through the commands, use the up/down buttons (lever key and pushbutton panels) under the command window.

On rotary panels use the rotary control and the talk button.

11.4.1 Version

The version command shows the versions of various components of the system.

Display 2 shows the component and may be adjusted. Display 3 shows the version of that component.

Note: *The versions are not adjustable.*

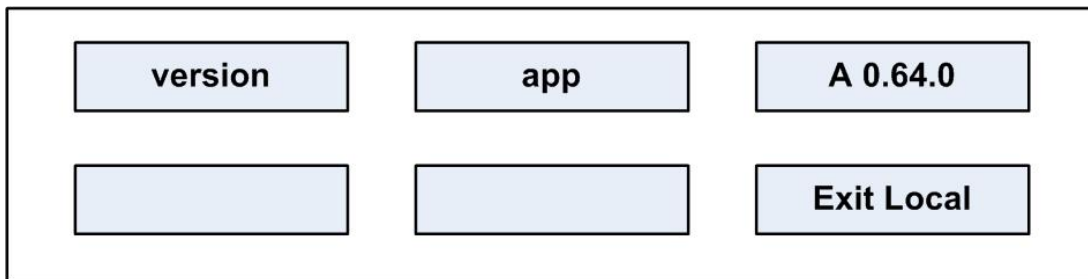

To scroll through the panel software components, press the up/down keys (lever key and pushbutton panels) or use the rotary control and talk button (rotary panels) under the app display.

The components shown in display 2 are as follows:

Component	Description / comments
app	The panel application version
kernel	The linux kernel version
rootfs(v)	The version (v) of the kernel root file system
rootfs(d)	The date (d) of the kernel root file system
modules	The version of the module firmware and bootloader
sound	The version of the sound drivers

11.4.2 xpoint

The xpoint command enables you to adjust the values of the crosspoints in the panel's audio mixer.

Display 2 displays the output audio stream.

Display 3 shows the input audio stream.

Display 4 shows the value of the crosspoint in dB. A value of -80 signifies no audio, and a value of 0 signifies all on.

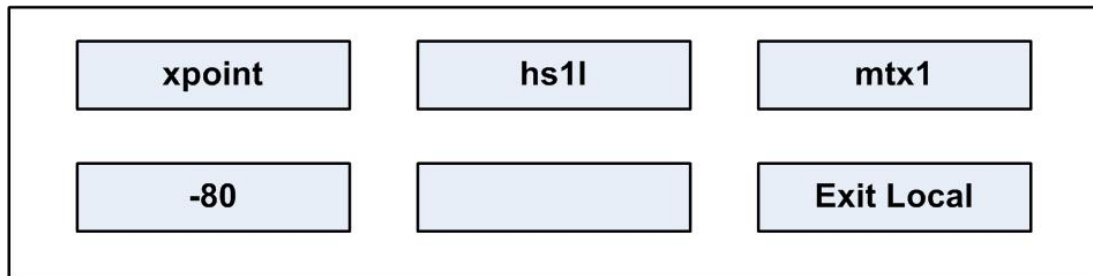

The output streams displayed in window 2 can be scrolled through using the up/down volume keys under display 2 (lever key and pushbutton panels).

On rotary panels use the rotary control and talk button to scroll through the output streams.

The output audio stream crosspoint options are:

Crosspoint options	Description / comments
hs1l	Headset 1 left ear
hs1r	Headset 1 right ear
hs2l	Headset 2 left ear
hs2r	Headset 2 right ear
ls	Main loudspeaker
auxls	Auxiliary loudspeaker
mtx1	Mono audio to the matrix via the analogue connection
mtx2	Second channel of stereo to matrix
ext1	External output 1 on auxiliary audio connector
ext2	External output 2 on auxiliary audio connector
hotmic	Output to hot microphone on auxiliary audio connector
larec	Listen again output
voicerec	Message recording output

The input audio stream crosspoint options are:

Crosspoint options	Description / comments
mtx1	Input mono audio from the matrix using the analog connection
mtx2	Input a second channel of stereo from the matrix
ext1	Input from external input 1 on the auxiliary audio connector
ext2	Input from external input 2 on the auxiliary audio connector
hs1	Input from headset 1 microphone
hs2	Input from headset 2 microphone
tone	Test tone input
laplay	Listen again input
voiceplay	Message recording input

11.4.3 Level

The level command enables you to change the internal level (volume) controls.

Display 2 shows the controller name.

Display 3 shows the controller value.

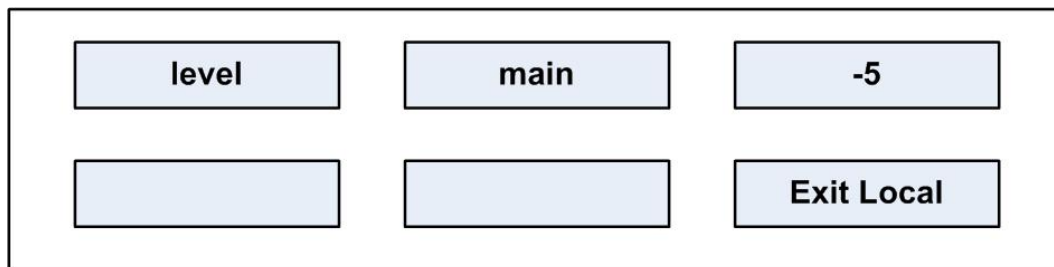

Five level options shown in display 2 can be set using the up/down buttons (lever key and pushbutton panels) or the rotary encoder and talk button (rotary panels).

The level options are:

Level options	Description / comments
main	Main internal level (volume) controller
aux	Auxiliary internal level (volume) controller
st1	Sidetone 1 internal level (volume) controller

Level options	Description / comments
st2	Sidetone 2 internal level (volume) controller
po	Page override controller

11.4.4 Control

This command allows the controller of a crosspoint to be changed.

Display 2 shows the output streams.

Display 3 shows the input stream.

Display 4 shows the controller name for that crosspoint.

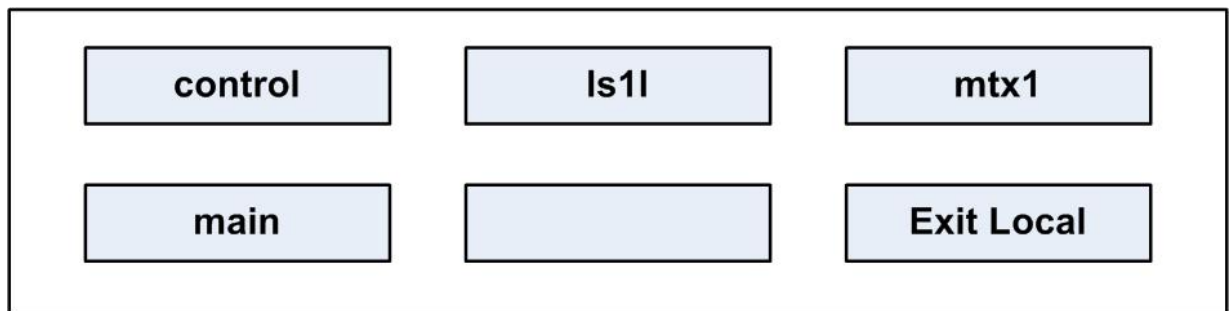

The output audio stream crosspoint options are:

Crosspoint options	Description / comments
hs1l	Headset 1 left ear
hs1r	Headset 1 right ear
hs2l	Headset 2 left ear
hs2r	Headset 2 right ear
ls	Main loudspeaker
auxls	Auxiliary loudspeaker
mtx1	Mono audio to the matrix via the analogue connection
mtx2	Second channel of stereo to matrix
ext1	External output 1 on auxiliary audio connector
ext2	External output 2 on auxiliary audio connector

Crosspoint options	Description / comments
hotmic	Output to hot microphone on auxiliary audio connector
larec	Listen again output
voicerec	Message recording output

11.4.5 The Input Audio Stream Crosspoint

The input audio stream crosspoint options are:

Crosspoint options	Description / comments
mtx1	Input mono audio from the matrix using the analog connection or one channel of stereo using an AES-3 card
mtx2	Input a second channel of stereo from the matrix via the AES-3 card
ext1	Input from external input 1 on the auxiliary audio connector
ext2	Input from external input 2 on the auxiliary audio connector
hs1	Input from headset 1 microphone
hs2	Input from headset 2 microphone
tone	Test tone input
laplay	Listen again input
voiceplay	Message recording input

The crosspoint controller options are:

Crosspoint options	Description / comments
main	Main internal level (volume) controller assigned
aux	Auxiliary internal level (volume) controller assigned
none	No controller assigned

11.4.6 Limit

The limit command allows various operating parameters of the digital limiters to be viewed and adjusted.

Display 2 shows the input stream of the limiter being accessed.

Display 3 shows the parameter for the limiter.

Display 4 shows its current value.

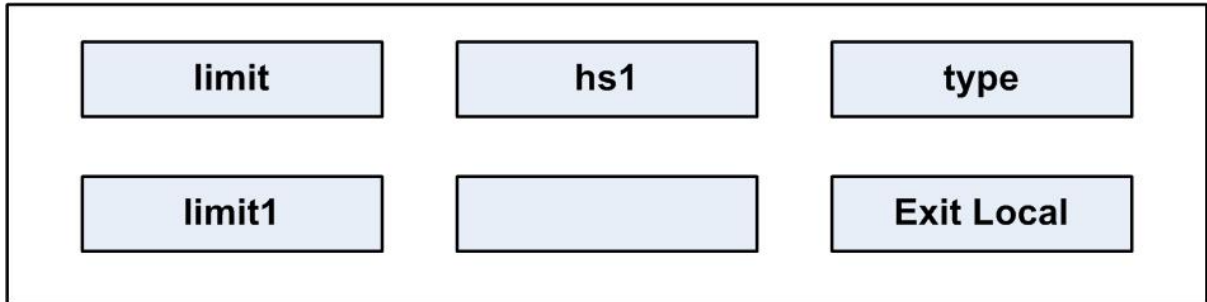

11.4.7 Input Streams

The available input streams shown in display 2 are:

Options	Description / comments
hs1	Input from headset 1 microphone
Hs2	Input from headset 2 microphone

The available limiters are shown in display 3 and the limiter parameters and units are shown in display 4.

The limiters are described below:

Options	Description / comments
type	Select a preset limiter from the range limit1 - limit6 shown in display 4.
enable	Select yes or no in display 4 to enable/disable this limiter
decay	Decay time in ms shown in display 4
attack	Attack time in ms shown in display 4
knee	Knee in dB shown in display 4
comp	Compression shown in display 4
gain	Markup gain of limiter in dB shown in display 4
thresh	The threshold below which the limiter has no effect shown in display 4

11.4.8 Filter

The filter command allows the current filter to be displayed and changed.

Display 2 shows the input stream of the filter being accessed.

Display 3 shows the action.

Display 4 shows the action status.

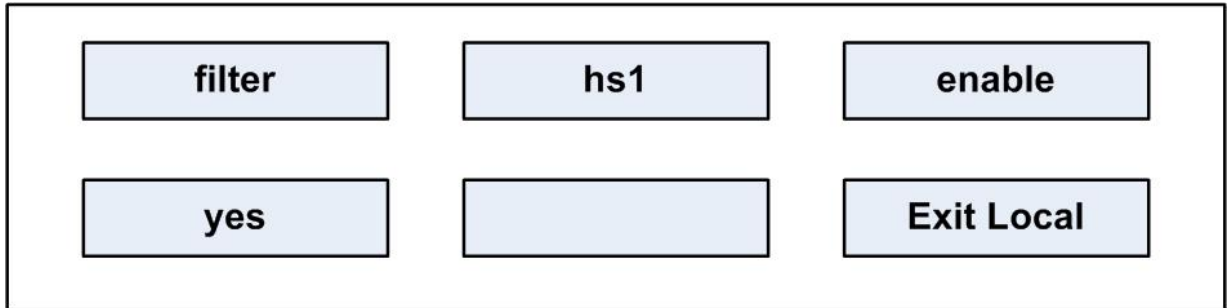

11.4.9 Input Streams

The available input streams in display 2 are:

Options	Description / comments
hs1	Input from headset 1 microphone
hs2	Input from headset 2 microphone
ext1	Input from external input 1 on the auxiliary audio connector
ext2	Input from external input 2 on the auxiliary audio connector
mtx1	Input mono audio from the matrix via the analogue connection or one channel of stereo via an AES-3 card
mtx2	Input a second channel of stereo from the matrix via the AES-3 card

The available filter options in display 3 are:

Options	Description / comments
Options	Description / comments
enable	Action to enable the filter

The available action options in display 4 are:

Options	Description / comments
yes	Enable filter
no	Disable filter

11.4.10 la (Listen Again)

The la command allows various controls for the Listen Again system to be displayed and changed.

Display 2 shows the parameter name.

Display 3 shows the parameter value.



The parameter names and values are shown below:

Parameter	Description / comments
threshold	The signal level in dB needed to trigger the Listen Again recording
maxsilence	The maximum time in ms that silence will not cause fragmentation of a message
stale	The time in seconds after which a message will be deleted
startsil	The duration in ms of silence preceding message playback
starttone	The duration in ms of the start tone during playback
endsilence	The duration in ms of the silence after playing back a message
endtone	The duration in ms of the end of messages tone during playback

11.4.11 Mixer

The mixer control enables control of a number of mixer inputs and outputs.

Display 2 displays inputs or outputs.

Display 3 shows the number of inputs or outputs.

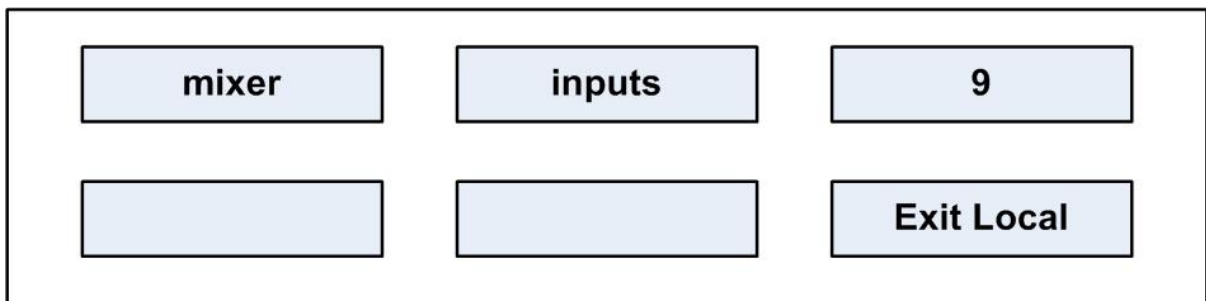

11.4.12 Setup

The setup command allows all the audio settings to be saved and restored from a file in nonvolatile memory on the panel. This is an action command.

Display 2 shows save or restore.

Display 3 shows DO IT, and when the command is executed shows DONE.

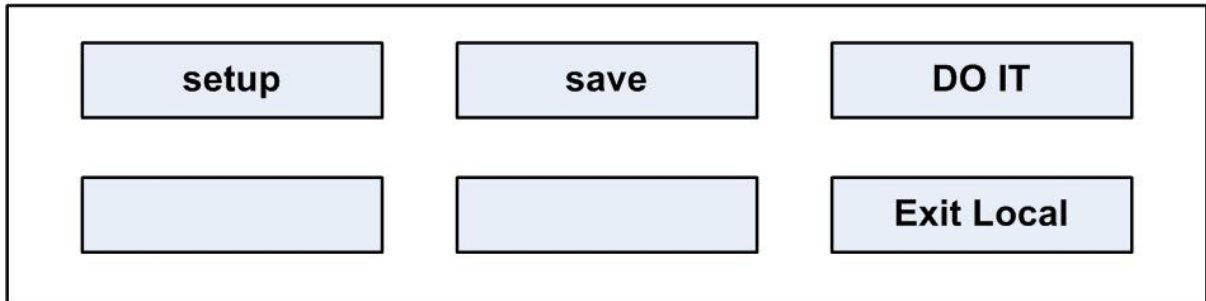

The action options in display 2 are:

Options	Description / comments
save	Save the settings to a file
restore	Restore settings to a file

The options in window 3 are:

Options	Description / comments
DO IT	Execute the save or restore action
DONE	Save or restore action completed

11.4.13 Voicerec

The voicerec command allows the voice message recording system to be controlled. They are all action commands.

Display 2 shows the command.

Display 3 shows the action.

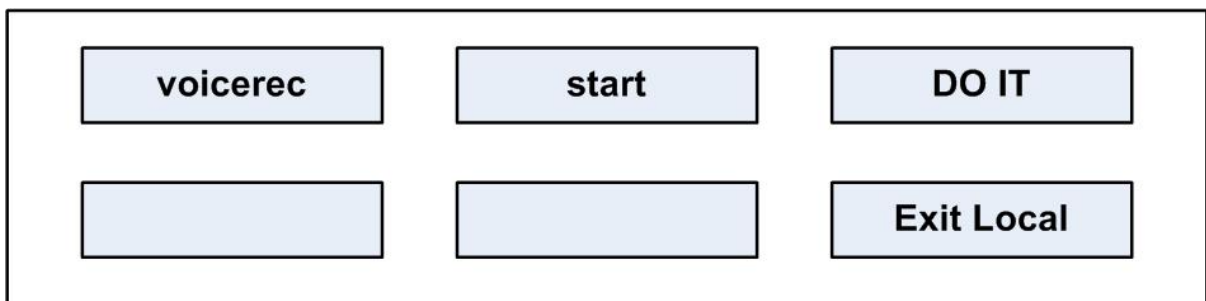

The commands in display 2 are as follows:

Options	Description / comments
start	Start the voice recording system
stop	Stop the voice recording system
erase	Erase the recorded message

The action in display 3 is:

Options	Description / comments
DO IT	Execute or restore action

11.4.14 Voiceplay

This command controls the playback of the voice recording system. Display 2 shows the command and display 3 shows the available action.

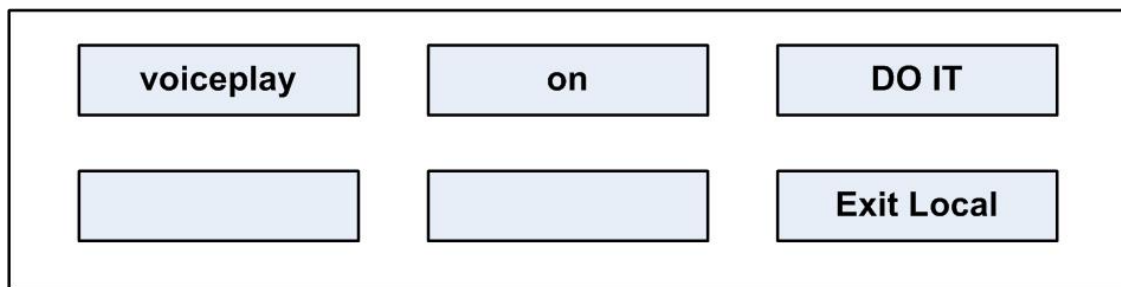

The available commands in display 2 are:

Options	Description / comments
on	Turn voice recording playback on
off	Turn voice recording playback off

The action in display 3 is:

Options	Description / comments
DO IT	Execute or restore action.

11.4.15 intrim

The intrim command allows the trim, or gain, to be adjusted on each of the input streams.

Display 2 shows the stream name.

Display 3 shows the trim in dB.

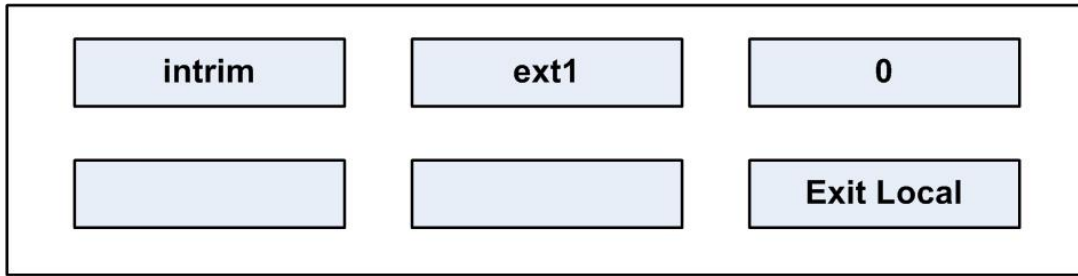

The available input channels where the trim can be set are:

Options	Description / comments
ext1	Input from external input 1 on the auxiliary audio connector
ext2	Input from external input 2 on the auxiliary audio connector
hs1	Input from headset 1 microphone
hs2	Input from headset 2 microphone on the auxiliary audio connector

11.4.16 outtrim

The outtrim command allows the trim, or gain, to be adjusted on each of the input streams.

Display 2 shows the stream name.

Display 3 shows the trim in dB.

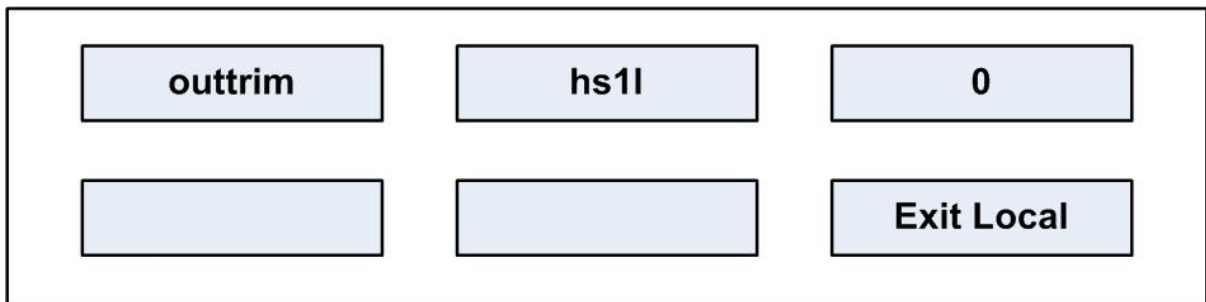

The available output channels where the trim can be set are:

Options	Description / comments
hs1l	Headset 1 left ear
hs1r	Headset 1 right ear
hs2l	Headset 2 left ear
hs2r	Headset 2 right ear
ls	Main loudspeaker

Options	Description / comments
auxls	Auxiliary loudspeaker
mtx1	Mono audio to the matrix via the analogue connection
mtx2	Second channel of stereo to matrix
ext1	External output 1 on auxiliary audio connector
ext2	External output 2 on auxiliary audio connector
hotmic	Output to hot microphone on auxiliary audio connector

11.4.17 gpio

This menu shows the current setting of the discrete digital inputs in the panel General Purpose Input (GPIO) facility.

Display 2 shows the input name.

Display 3 shows its value.

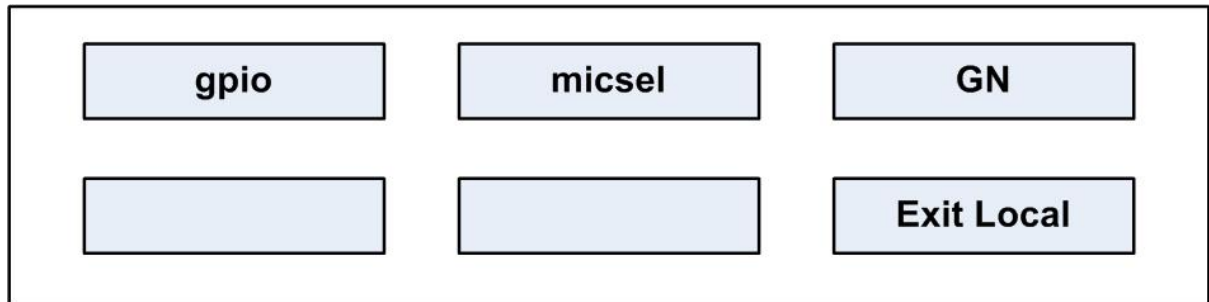

The input names and permissible values are show in the table below:

Input names	Values
micsel	GN/HS
mic1gain	number 0..15
mic1bal	bal/unbal
mic1bias	on/off
hs2gain	number 0..15
hs2bal	bal/unbal
hs2bias	on/off
fled0	on/off. This controls the function LED 0 on the front panel

Input names	Values
fled1	on/off. This controls the function LED 1 on the front panel
fled2	on/off. This controls the function LED 2 on the front panel
fled3	on/off. This controls the function LED 3 on the front panel
lscut	cut/uncut
xlvl	on/off
lev0	number 0..15
lev 1	number 0..15
relay0	closed/open
relay1	closed/open

11.4.18 module

The module command allows commands to be sent to the display modules.

Display 2 shows the command.

Display 3 shows the value.

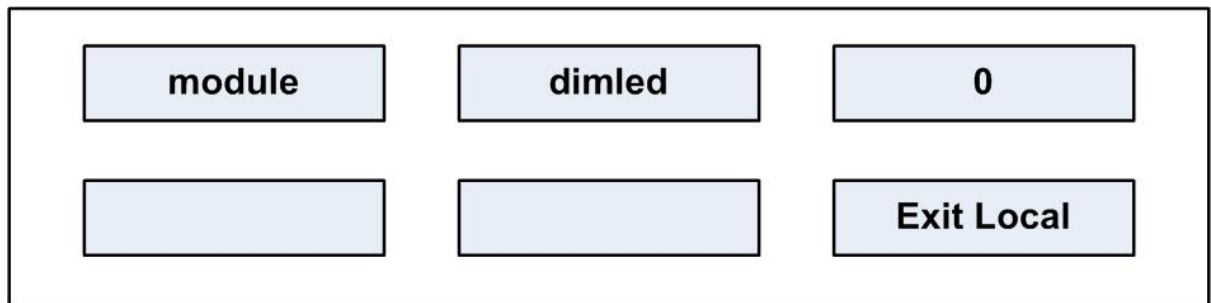

The commands and permissible values are as follows:

Input names	Values
dimled	Number 0..50. This sets the brightness level for the LEDs.

12 Upgrading the IrisX panel

The IrisX panel can be upgraded via the USB connectors on the panel or centrally using the EHX software.

Currently, your panel can only be upgraded using the EHX software if it is connected by AES67. If your panel is connected by analogue MVX or IVC IP, you must upgrade your panel by USB.

When performing software updates, start the update and do NOT touch the panel until update is completed. Set a timer for 10 minutes to ensure enough time is allowed for the update.

12.1 Upgrade the panel using the EHX software

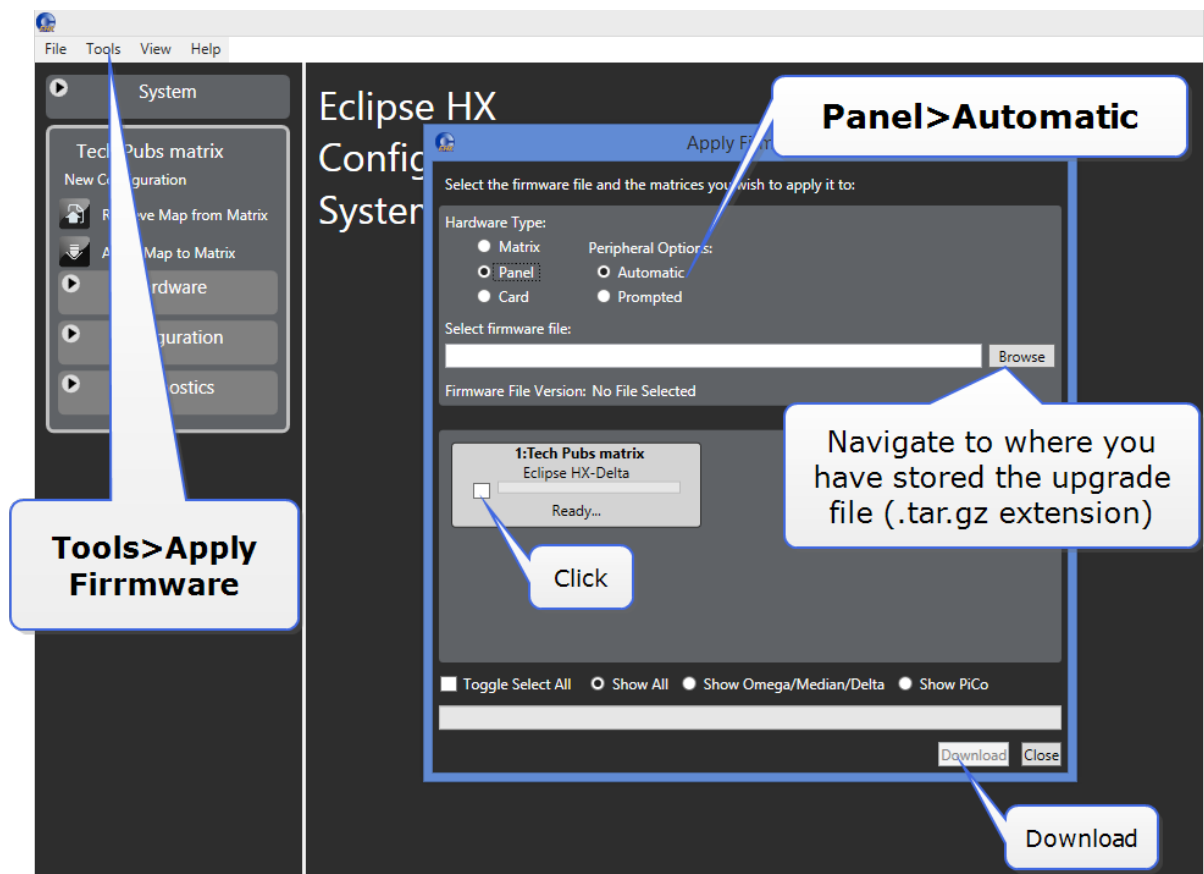

12.2 Upgrade the panel by USB

If your panel is connected by analogue MVX or IVC IP, you must upgrade your panel by USB.

1. Rename the .tar.gz file to **IRIS.gz** or **IRIS.ccf** and place it in the root file of your USB stick.
2. Insert the USB into the connector on either the front or the back of the device and follow the panel menu as usual.

3. Make sure the IrisX panel is either not connected to the matrix (panel needs to be off line)
OR in the local menu screen.

Only connect a single USB device to the panel during the upgrade.

Do not connect a USB to both connectors at the same time.

Currently, upgrade can take up to 10 mins (worst case) if the FPGA needs updating.

13 Compliance

This chapter describes the regulatory compliance of the product.

13.1 V-Series IrisX Panels – User Guide Compliance Section

- Applicant Name: Clear-Com LLC
- Applicant Address: 1301 Marina Village Pky, Suite 105, Alameda CA 94501, USA
- Manufacturer Name: HM Electronics, Inc.
- Manufacturer Address: 2848 Whiptail Loop W, Carlsbad, CA 92010, USA
- Country of Origin: USA
- Brand: CLEAR-COM
- Product Name: Eclipse V-Series IrisX Panel
- Product Regulatory Model Number: VI-PNLB-XX and VI-EXPB-XX (where suffix X is alphanumeric for number of keys on IrisX series panel or IrisX series expansion panel)
- Country of Origin: USA

Caution: All products are compliant with regulatory requirements detailed in this document when installed correctly in Clear-Com product per Clear-Com specifications.

Caution: Product modification not expressly approved by the party responsible for compliance can void the user's authority to operate the equipment

13.2 USA FCC EMC Class A

This device complies with part 15 of the FCC Rules. Operation is subject to the following two conditions: (1) This device may not cause harmful interference, and (2) this device must accept any interference received, including interference that may cause undesired operation.

Note: This equipment has been tested and found to comply with the limits for a Class A digital device, pursuant to part 15 of the FCC Rules. These limits are designed to provide reasonable protection against harmful interference when the equipment is operated in a commercial environment. This equipment generates, uses, and can radiate radio frequency energy and, if not installed and used in accordance with the instruction manual, may cause harmful interference to radio communications. Operation of this equipment in a residential area is likely to cause harmful interference in which case the user will be required to correct the interference at his own expense.

13.3 Canada ICES-003 EMC Class A

Industry Canada ICES-003 Compliance Label: CAN ICES-3 (A)/NMB-3(A)

This Class A digital apparatus complies with Canadian ICES-003.

Cet appareil numérique de la classe A est conforme à la norme NMB-003 du Canada.

13.4 European Union (CE)



Hereby, Clear-Com Inc declares that the products described herein are in compliance with the following directives:

EMC Directive 2014/30/EU

Restrictions of the use of certain hazardous substances (RoHS) Directives 2011/65/EU and (EU) 2015/863

Standards:

EN 55035

EN 61000-3-2

EN 61000-3-3

EN 63000

EN55032

13.5 United Kingdom (UKCA Mark)

The UKCA (UK Conformity Assessed) marking is a new UK product marking that will be used for goods being placed on the market in Great Britain (England, Wales and Scotland). The UKCA marking alone cannot be used for goods placed on the Northern Ireland market, which require the CE marking or UK(NI) marking.



13.6 Directives

EMC Directive 2014/30/EU

Restrictions of the use of certain hazardous substances (RoHS) Directives 2011/65/EU and (EU) 2015/863

13.7 Standards:

EN 55032

EN 55035

EN 63000

EN 61000-3-2

EN 61000-3-3

13.8 Korea KCC EMC Registration



For EMC Class A Equipment

이 기기는 업무용(A급) 전자파 적합기기로서 판매자 또는 사용자는 이 점을 주의하시길 바라며, 가정 외의 지역에서 사용하는 것을 목적으로

Customs Union EAEU



14 Specifications

Note: 0 dBu is referenced to 0.775 V RMS

14.1 Front panel controls and connectors

Control / Connector	Description / comments
Talk/Listen Switches	11 or 23
Answer Back Switch	1
Volume Controls	2
Headset Connector	1 XLR-4M or XLR-5F or XLR-7M
Panel Mic Connector	1 3-pin

14.2 Main panel rear connectors

Connector	Description / comments
GPIO	DB-25F
To Matrix	RJ-45
Auxiliary Audio	DB-25M
Expansion	RJ-45
LAN 1-2	RJ-45
DC Power	4 Pin

14.3 Expansion panel rear connectors

Connector	Description / comments
Expansion In	RJ-45
Expansion Out	RJ-45
DC Power	4 Pin

14.4 Panel microphone input

Characteristic	Description / comments
Type	Electret, dynamic balanced, dynamic unbalanced
Input Level	-70 to -40dBu
Impedance	1700 Ohms +/- 10% Electret mic 1000 Ohms +/- 10% Dynamic mic

14.5 Headset microphone input

Characteristic	Description / comments
Type	Electret or Dynamic
Input Level	-70 to -40dBu

14.6 Auxiliary loudspeaker output

Characteristic	Description / comments
Nominal Output	0dBu
Maximum Output	+18dBu
Output Impedance	100 Ohms

14.7 Audio input/output (MVX-Analogue)

Characteristic	Description / comments
Bandwidth	30 Hz - 22 kHz
Headroom	+18 dBu
Noise	<-70 dBu rms (20-22 kHz)

Characteristic	Description / comments
THD	<0.02% @ 1kHz
Input impedance	120 kOhms
Output impedance	50 Ohms

14.8 AC mains power supply (external)

Characteristic	Description / comments
Voltage	100 - 240VAC
Frequency	50 - 60 Hz
Power	60W maximum

14.9 Temperature

Characteristic	Description / comments
Operating	Range: 0° - 40° C (32 to 104 F)
Storage	Range 0° - 70° C (32 to 150 F)

14.10 Humidity

Characteristic	Description / comments
Operation and storage	Between 20% and 90% Non-Condensing

14.11 Dimensions (1RU panels)

Characteristic	Description / comments
Height	1.72 in. (4.36 cm), (1 RU, EIA rack)
Width	19.0 in. (48.26 cm)
Depth	6.84 in. (17.37 cm) with PSU mount 4.62 in (11.73 cm) without PSU mount
Weight	Rotary 4.23 lbs. (1.92 kg) Push 4.17 lbs. (1.89 kg) Lever 4.35 lbs. (1.97 kg)

14.12 Dimensions (2RU panels)

Characteristic	Description / comments
Height	3.47 in. (8.81 cm), (2 RU, EIA rack)
Width	19.0 in. (48.26 cm)
Depth	Rotary 6.84 in. (17.37 cm) with PSU mount 4.62 in (11.73 cm) without PSU mount Push 6.84 in. (17.37 cm) with PSU mount 4.62 in (11.73 cm) without PSU mount Lever 6.75 in. (17.15 cm) with PSU mount 4.54 in. (11.53 cm) without PSU mount
Weight	Rotary 6.45 lbs. (2.93 kg) Push 6.27 lbs. (2.85 kg) Lever 6.13 lbs. (2.78 kg)

14.13 Dimensions (Expansion panels)

Characteristic	Description / comments
Height	1.72 in. (4.36 cm)
Width	19.0 in. (48.26 cm)
Depth	<p>Rotary 6.51 in. (16.54 cm) with PSU mount 4.24 in (10.80 cm) without PSU mount</p> <p>Push 6.42 in. (16.31 cm) with PSU mount 4.15 in (10.54 cm) without PSU mount</p> <p>Lever 6.56 in. (16.66 cm) with PSU mount 4.32 in (10.98 cm) without PSU mount</p>
Weight	<p>Rotary 3.59 lbs. (1.63 kg)</p> <p>Push 3.54 lbs. (1.61 kg)</p> <p>Lever 3.49 lbs. (1.58 kg)</p>

15 Appendix: IrisX panel dip switches and D25 pinouts

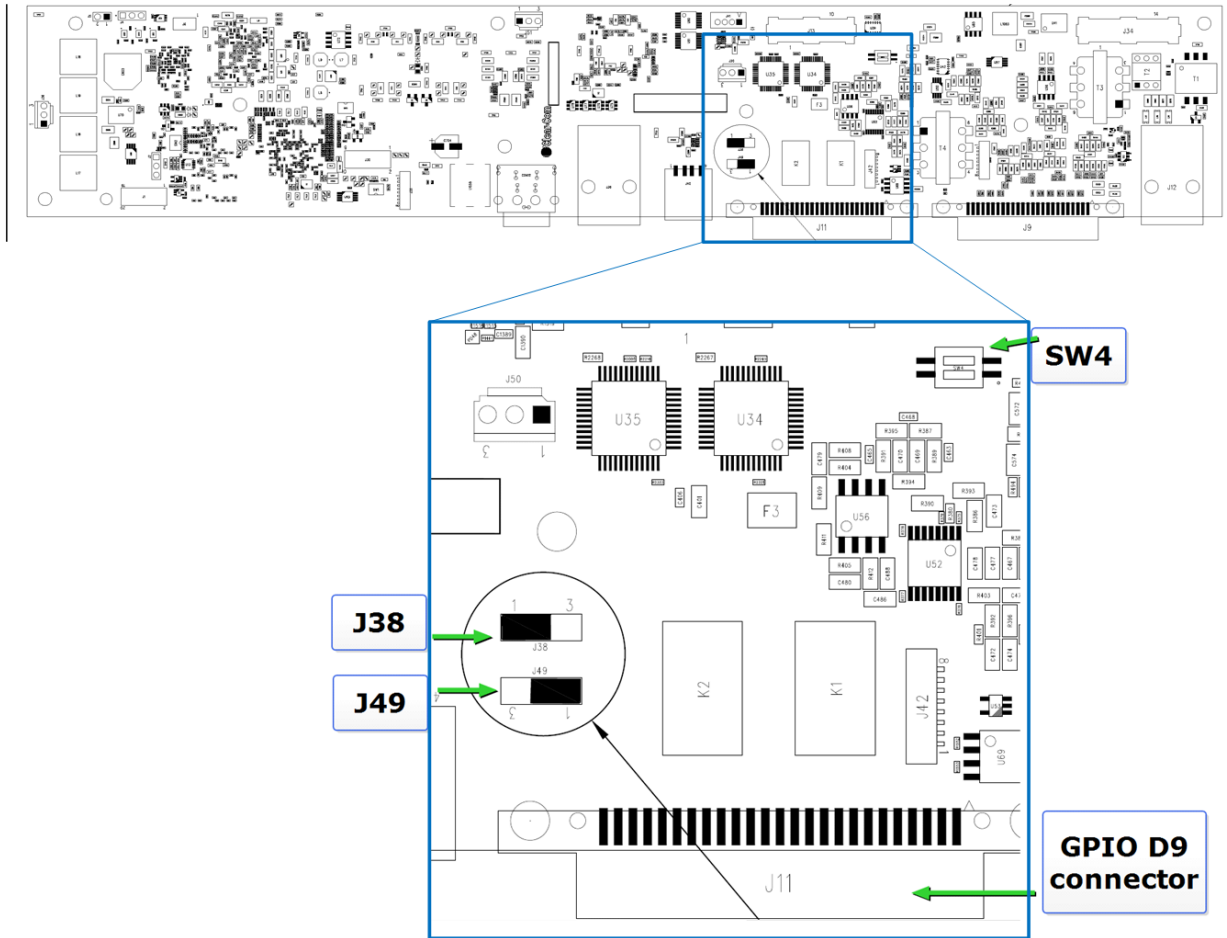

IrisX panel dip switches and GPIO connector

15.1 SW4 = Headset autodetect.

See [Headset autodetect on page 54](#).

15.2 DB25 Male analog expansion connector(J9 on rear panel)

Pin 13	Auxiliary power with 0.2A resettable fuse (polyfuse)
Pins 5,6,18,19	Analog ground (OVA)

Two jumper switches select the power that runs to J9, pin 13:

- J38 - selects either GND or Power to pin 13
 - 1-2 = select power (power is selected by J49)
 - 2-3 = select GND
- J49
 - 1-2 = select 5VA power
 - 2-3 = select 12V power

15.3 DB25 Female expansion GPIO (J11 on rear panel)

Pins 8,9	Digital Ground
Pins 20,21	5V power with 0.5A resettable fuse (polyfuse)

16 Glossary

Term	Definition
Analog Port	Any of the matrix's analog input/output RJ-45 connectors that are used to connect cable from the matrix to panels and interfaces. Each port connects to a separate audio channel in the matrix.
Alias label	A label that is temporarily assigned and replaces a previously labeled port or conference.
Bus	A bus is the channel or path between the components in the matrix along which electrical signals flow to carry information from one component to the next. In the Eclipse matrix the bus is located in the etched surface of the midplane.
Call signal	A call signal is an electronic signal sent from one panel or interface to another. A call signal can be audible and/or visual. Typically a call signal is sent to get the attention of a panel operator who may have turned down their intercom speaker's volume or removed their headset. It can also be sent to activate an electronic relay.
Canvas	The assignment area of the Dynam-EC software which can save any user labeled background.
Category-5 (CAT-5) cable	EIA/TIA 568 category specification relating to network cabling. Shielded category-5 cabling is required for Eclipse matrix wiring.
CellCom [®]	Digital wireless communications product. Sold under the CellCom name in USA and as FreeSpeak in Europe and Asia.
Central matrix	The term central matrix is used to differentiate the central hardware and software of the intercom system from the connected audio devices. The central matrix consists of: <ul style="list-style-type: none"> • The metal housing for the circuit cards and power supplies. • The circuit cards. • The power supplies. • The rear panel connectors which connect the matrix's hardware to panels and interfaces.

Term	Definition
Conference	An internal matrix virtual partyline or busbar where many panels and interfaces can talk onto or listen from the party line without talking to themselves.
Destination	A device such as an intercom panel, beltpack, or interface to which audio signals are sent. The device from which audio signals are sent is called a source.
Duplex	All real-time communication between individuals talking face to face is full duplex, meaning that they can both talk and listen simultaneously. The Eclipse matrices provide full-duplex audio.
EHX	EHX is the Eclipse configuration software. EHX guides the operation of the matrix circuit cards and connected panels.
Ethernet	International standard which describes how information is transmitted across a network. Provides for the efficient organization of network components.
Fiber optic cable	A fiber-optic cable consists of a glass core covered with a reflective material called cladding and several layers of buffer coating to protect the cable from the environment. A laser sends light pulses through the glass core to the other end of the cable.
Fixed Group	In a Fixed Group communication configuration, an operator speaks to all members of a group at once, in the manner of an announcer. However, if a group member responds by calling the operator back with their answer-back key, the audio path goes to the operator panel only. This mode can be contrasted with a conference or partyline configuration in which all members of a group can speak to all other members at the same time.
FreeSpeak®	Digital wireless communications product. Sold under the FreeSpeak name in Europe and Asia and CellCom name in USA.
FreeSpeak II™	Digital wireless communications product.
Full duplex	Refers to transmission of signals in two directions simultaneously.
Hopping	Refers to making a trunk connection through other matrices to a destination matrix.
Hosted Direct	Refers to the default port function when one or two extra IP channels are configured.

Term	Definition
IFB	Interruptible Foldback. The term foldback refers to sending program audio / feed, or some other audio mix, back to announcers while they are on the air. Doing so allows announcers to monitor themselves, other announcers, videotapes of commercials, or some mix of sources, while they on the air. This is typically found in television news and live broadcast events. Announcers usually wear a small ear piece so they can hear the selected foldback audio mix. When a director wants to give directions to an announcer on air, or to announce changes in the program, the director must interrupt the foldback. To do this, the director uses a channel specifically set up to interrupt the foldback audio.
Interface module	A piece of electronic hardware designed to convert the 4-wire signals of a central matrix port to some other form of communication, such as 2-wire partyline, telephone, etc. The interface module is connected to a central matrix port. The external non-4-wire device is then connected to the interface module.
ISO	The ISO function, short for panel ISOLation, allows a panel operator to call a destination and interrupt all of that destination's other audio paths and establish a private conversation. When the call is completed the destination's audio pathways are restored to their original state before the interruption.
Keygroup	KeyGroups provide a way of assigning a label to multiple panels simultaneously even within a networked matrix system. Once the KeyGroups have been defined using EHX, all the keys within a KeyGroup can be changed with a single assignment in Dynam-EC.
Label	A label is an alphanumeric name of up to five characters that identifies a source, destination, or control function accessed by an intercom panel. Labels appear in the displays of the intercom panel. Labels can identify panels, ports interfaced to other external equipment, fixed groups, party lines, and special control functions.
MADI	Multichannel Audio Digital Interface. The MADI or AES10 electronic communications protocol defines the data format and electrical characteristics of an interface carrying multiple channels of digital audio.
Multiplexing	The process by which two or more signals are transmitted over a single communications channel. Examples include time division and wavelength division multiplexing.

Term	Definition
Non-volatile Memory	Data stored in the CPU's firmware (ROM) that is not lost when the power is turned off.
Palette	The port, KeyGroup and Monitor selection screen in Dynam-EC.
Panel	Any intelligent intercom device connected to the rear-panel analog ports of the central matrix. This term does not refer to devices connected through interface modules.
Partyline	A wired shared communication system based on a single screened pair of wires. See the Encore range. Matrix requires the CCI-22 to interface to it.
Port	Any of the input/output connections (RJ-45 connectors) on the back panel of the central matrix. These connectors and the attached cables connect the central matrix to remote intercom devices. The term port emphasizes that the connection is a portal between the central matrix and the remote intercom devices.
Program	Any separate audio source that is fed into the intercom channels. In television applications, for example, the program audio is the audio that is broadcast on air.
Rack Unit (RU)	Standardized unit of mounting space on a rack panel. Each rack unit is 1.75 inches (44.45 mm) of vertical mounting space. Therefore 1 RU is 1.75 inches (44.45 mm) of vertical mounting space, 2 RU is 3.5 inches (88.9 mm), 3 RU is 5.25 inches (133.35mm), and so on.
Remote panel	Any intelligent intercom device connected to the back-panel ports of the system frame (matrix). This term does not refer to devices connected through interfaces.
Sidetone	The sound of the panel operator's voice, as heard in their own earphone (s) as they speak.
Source	In this guide, the term source refers to a device (such as an intercom panel, interface, or beltpack) that sends audio into the matrix. The device to which audio is sent is called a destination.
VOX	In the Eclipse HX system, when audio at a panel exceeds a threshold, a light switches on at the panel's port card to visually cue the operator. The threshold level is set in the EHX configuration software.